



**Defender® 6000 Indicators
Instruction Manual**

**Defender® 6000 Waagen
Bedienungsanleitung**

**Indicadores Defender® 6000
Manual de instrucciones**

**Manuel d'instructions sur les
indicateurs de Defender® 6000**

**Indicatori® Defender 6000
Manuale di istruzioni**

TABLE OF CONTENTS

1.	INTRODUCTION	3
1.1	SAFETY PRECAUTIONS	3
1.2	INTENDED USE	3
1.3	OVERVIEW OF PARTS AND CONTROLS.....	4
1.4	MAINBOARD	5
1.5	CONTROL FUNCTIONS	6
2.	INSTALLATION	9
2.1	UNPACKING.....	9
2.2	EXTERNAL CONNECTIONS	9
2.2.1	SCALE BASE WITH EASYCONNECT™ CONNECTOR.....	9
2.2.2	POWER INPUT TO I-DT61PW.....	9
2.2.3	AC POWER TO I-DT61XWE	9
2.3	INTERNAL CONNECTIONS	9
2.3.1	OPENING THE HOUSING	9
2.3.2	SCALE BASE WITHOUT EASYCONNECT™ CONNECTOR	10
2.3.3	COMMUNICATION INTERFACE CABLE TO I-DT61PW	14
2.3.4	RS232 INTERFACE CABLE TO I-DT61XWE	15
2.4	MOUNTING BRACKET	15
3.	OPERATION.....	16
3.1	TURNING THE SCALE ON/OFF	16
3.2	WEIGHING MODE.....	16
3.2.1	ENTER THE MODE AND START WEIGHING.....	16
3.2.2	ACCUMULATION AND STATISTICS.....	16
3.2.2.1	SETTINGS	16
3.2.2.2	ACCUMULATION	16
3.2.2.3	VIEWING AND CLEARING STATISTICAL DATA.....	16
3.2.3	CHECK	17
3.1.2	Application Settings	18
3.2	Counting Mode.....	19
3.2.4	ENTER THE MODE	19
3.2.5	ESTABLISH AN APW.....	19
3.2.6	START COUNTING	19
3.2.7	APPLICATION SETTINGS	19
3.3	PERCENT MODE	19
3.3.1	ENTER THE MODE	20
3.3.2	ESTABLISH A REFERENCE WEIGHT	20
3.3.3	START PERCENT WEIGHING	20
3.3.4	APPLICATION SETTINGS	20
3.4	DYNAMIC MODE.....	20
3.4.1	ENTER THE MODE	20
3.4.2	START DYNAMIC WEIGHING	20
3.4.3	APPLICATION SETTINGS	21
3.5	FILLING MODE.....	21
3.5.1	ENTER THE MODE	21
3.5.2	START FILLING.....	21
3.5.3	RESUME AND PAUSE FILLING	22
3.5.4	DISPLAY OF THE DOT MATRIX SCREEN	22
3.5.5	APPLICATION SETTINGS	23
4.	MENU SETTINGS	24
4.1	MENU NAVIGATION	24
4.1.1	USER MENU	24
4.1.2	BUTTON NAVIGATION.....	25
4.2	CALIBRATION MENU	26
4.2.1	INITIAL CALIBRATION.....	26
4.2.2	ZERO CALIBRATION [ZERO].....	26
4.2.3	SPAN CALIBRATION [SPAN].....	26
4.2.4	LINEARITY CALIBRATION [L IN].....	27
4.2.5	GEO ADJUSTMENT [GEO]	27
4.2.6	CALIBRATION TEST [CAL TEST].....	28
4.2.7	END CAL [END].....	28

4.3	SETUP MENU	28
4.4	READOUT MENU	32
4.5	UNIT MENU	35
4.6	GLP/GMP MENU	35
4.7	COMMUNICATION	36
4.7.1	RS232 MENU	36
4.7.2	PRINT MENU	37
4.7.3	PRINTOUTS	40
4.7.4	RS485 CONFIGURATION	41
4.7.5	ETHERNET CONFIGURATION	41
4.7.6	ANALOG CONFIGURATION	41
4.8	MEMORY	41
4.8.1	MEMORY MENU (FOR I-DT61PW MODEL)	41
4.8.2	USB MEMORY (FOR I-DT61XWE MODEL)	41
4.8.3	ALIBI MEMORY (FOR I-DT61XWE MODEL)	42
4.8.3.1	ENABLE ALIBI	42
4.8.3.2	INSTALL ALIBI	42
4.9	DISCRETE I/O (FOR I-DT61XWE MODEL)	47
4.9.1	I/O TYPE	47
4.9.2	INPUT	48
4.9.3	OUTPUT	48
4.10	LOCK KEY CONFIGURATION	48
4.11	LIBRARY (FOR I-DT61XWE MODEL)	48
4.12	USER (FOR I-DT61XWE MODEL)	51
4.13	USB (FOR I-DT61XWE MODEL)	52
4.13.1	USB FLASH DRIVE	52
4.13.2	RFID	52
4.13.3	BARCODE	53
4.13.4	KEYBOARD	53
4.13.5	WI-FI/BLUETOOTH DONGLE (OPTIONAL)	53
4.13.5.1	INSTALL A WI-FI/BLUETOOTH USB DONGLE	53
4.13.5.2	CONFIGURATION	54
5.	LEGAL FOR TRADE	55
5.1	SETTINGS	55
5.2	VERIFICATION	55
5.3	SEALING	56
5.3.1	SEALING FOR BASE WITHOUT EASYCONNECT	56
5.3.2	SEALING FOR EASYCONNECT BASE WITH MEMORY MODULE	56
6.	MAINTENANCE	57
6.1	CLEANING	57
6.1.1	CLEANING FOR I-DT61PW MODEL	57
6.1.2	CLEANING FOR I-DT61XWE MODEL	57
6.2	TROUBLESHOOTING	57
6.3	SERVICE INFORMATION	58
7.	TECHNICAL DATA	59
7.1	SPECIFICATIONS	59
7.2	ACCESSORIES AND OPTIONS	61
7.3	TABLE OF GEO VALUES	62
8.	COMPLIANCE	63
9.	APPENDICES	65
9.1	APPENDIX A	65
9.2	APPENDIX B	67

1. INTRODUCTION

This manual contains installation, operation and maintenance instructions for i-DT61PW and i-DT61XWE indicators. Please read it completely before installation and operation.

1.1 Safety Precautions

Definition of Signal Warnings and Symbols

Safety notes are marked with signal words and warning symbols. These show safety issues and warnings. Ignoring the safety notes may lead to personal injury, damage to the instrument, malfunctions and false results.

WARNING	For a hazardous situation with medium risk, possibly resulting in severe injuries or death if not avoided.
CAUTION	For a hazardous situation with low risk, resulting in damage to the device or the property or in loss of data, or minor or medium injuries if not avoided.
ATTENTION	For important information about the product. May lead to equipment damage if not avoided.
NOTE	For useful information about the product.

Warning Symbols



General hazard



Explosion hazard



Electrical shock hazard

Safety Precautions



CAUTION: Read all safety warnings before installing, making connections, or servicing this equipment. Failure to comply with these warnings could result in personal injury and/or property damage. Retain all instructions for future reference.

- Before connecting power, verify that the AC adapter's input voltage range and plug type are compatible with the local AC mains power supply.
- Do not position the equipment such that it is difficult to reach the power connection.
- Only connect the power cord to a compatible grounded electrical outlet.
- Make sure that the power cord does not pose a potential obstacle or tripping hazard.
- Operate the equipment only under ambient conditions specified in these instructions.
- The equipment is for indoor use only.
- Do not operate the equipment in hazardous or unstable environments.
- Do not place the equipment upside down on the platform.
- Use only approved accessories and peripherals.
- The power plug is not waterproofed. Please disconnect the equipment from the power supply when cleaning.
- Service should only be performed by authorized personnel.



WARNING: Never work in an environment subject to explosion hazards! The housing of the instrument is not gas tight. (Explosion hazard due to spark formation, corrosion caused by the ingress of gases).



WARNING: Electrical shock hazards exist within the housing. The housing should only be opened by authorized and qualified personnel. Remove all power connections to the unit before opening.



WARNING: If the indicator is connected to a base with a memory module, please make the connection before powering on. If the base is connected to a powered indicator, the memory module may be damaged because it includes an electrostatic sensitive chip.

1.2 Intended Use

This instrument is intended for use in light industry. It must only be used for measuring the parameters described in these operating instructions. Any other type of use and operation beyond the limits of technical specifications, without written consent from OHAUS, is considered as not intended. This instrument complies with current industry standards and the recognized safety regulations; however, it can constitute a hazard in use. If the instrument is not used according to these operating instructions, the intended protection provided by the instrument may be impaired.

1.3 Overview of Parts and Controls

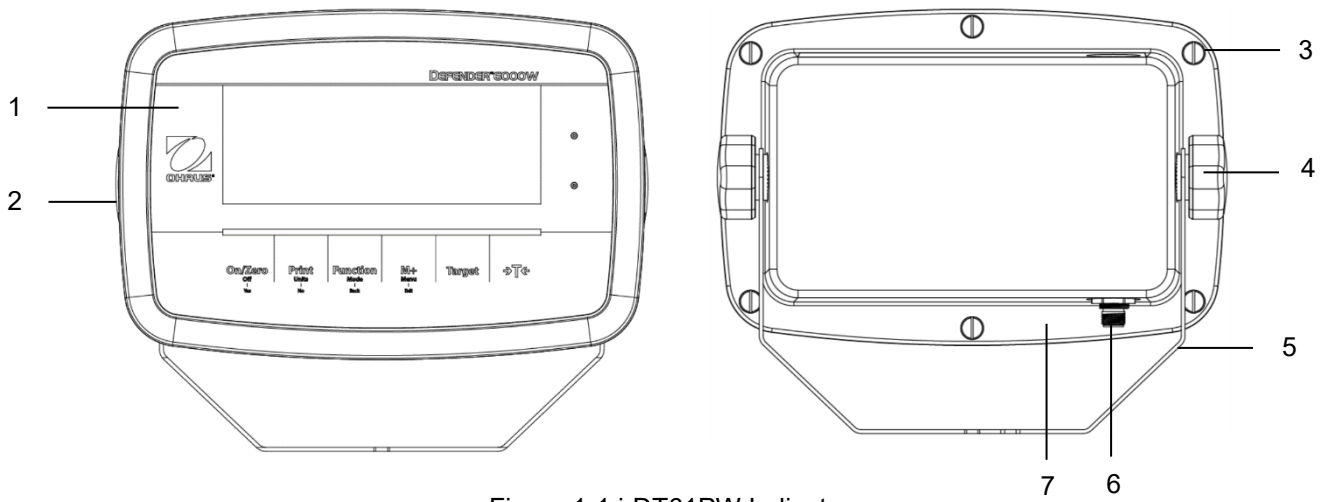

Figure 1-1 i-DT61PW Indicator

Item	Description
1	Control Panel
2	Front Housing
3	Screws (6)
4	Adjusting Knobs (2)
5	Mounting Bracket
6	Load Cell Connector
7	Rear Housing

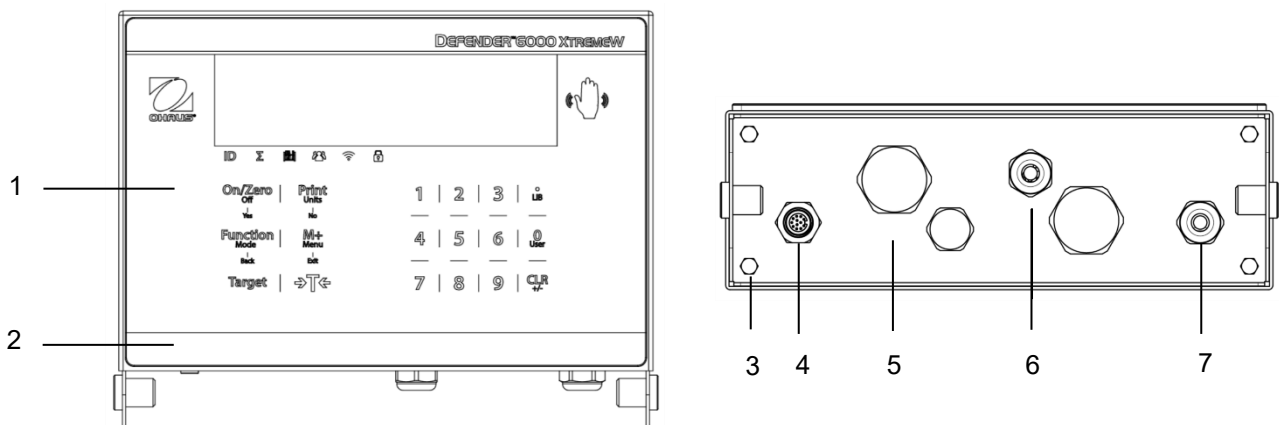
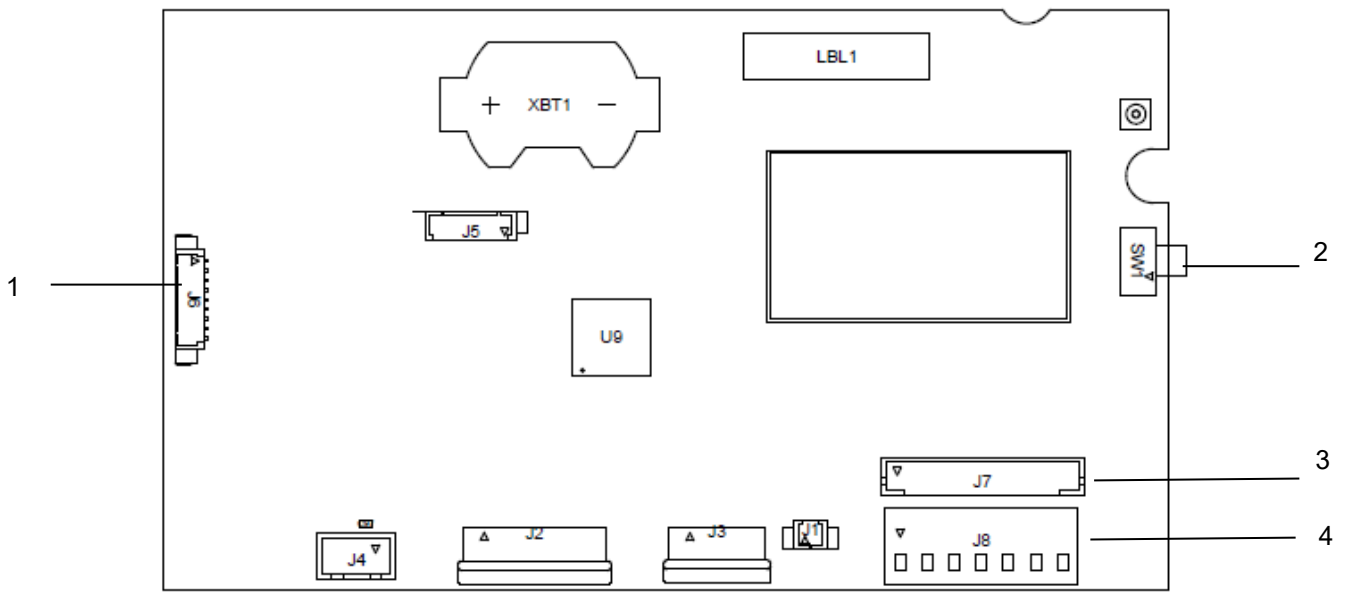

Figure 1-2 i-DT61XWE Indicator

Item	Description
1	Control Panel
2	Front Housing
3	Screws (4)
4	Load Cell Connector
5	Bottom Housing
6	Strain Relief for Option
7	Power cord

1.4 Mainboard



.Figure 1-3 i-DT61PW Mainboard

Item	Description
1	IR Communication connector (J6)
2	Security Switch (SW1)
3	Load Cell connector (J7)
4	Load Cell Terminal Block (J8)

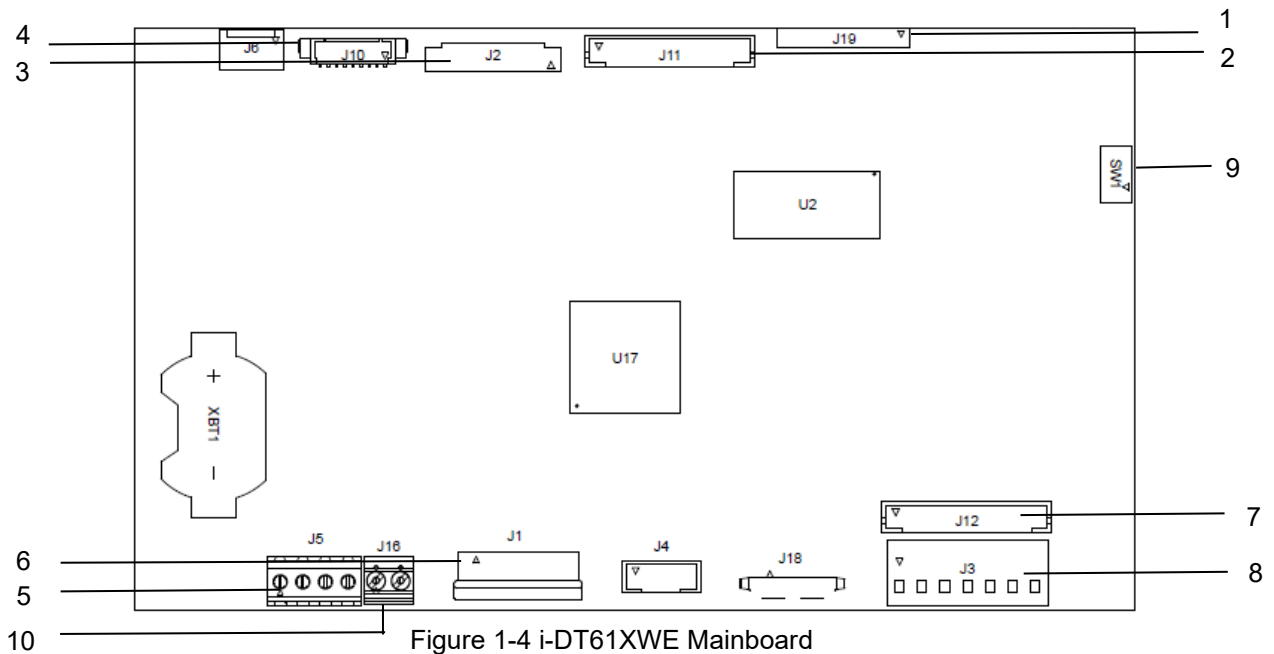

Figure 1-4 i-DT61XWE Mainboard

Item	Description	Item	Description
1	Alibi Memory Board connector (J19)	6	Keyboard connector (J1)
2	Discrete I/O/Analog/RS232-RS485-USB Device connector (J11)	7	Load Cell connector (J12)
3	Display Board connector (J2)	8	Load Cell Terminal Block (J3)
4	Ethernet connector (J10)	9	Security Switch connector (SW1)
5	RS232 connector (J5)	10	Discrete Input0 (J16)

1.5 Control Functions



i-DT61PW Control Panel



i-DT61XWE Control Panel

Button	On/Zero Off ↓ Yes	Print Units ↓ No	Function Mode ↓ Back	M+ Menu ↓ Exit	Target	→T←
Primary Function (Short Press)	On/Zero If the terminal is Off, press to power on; If the terminal is On, press to set the zero point.	Print Sends the current value to the selected COM ports if AUTOPRINT is disabled.	Function Initiates an application mode.	M+ Accumulates the weight or displays the accumulated information with no load on the pan.	Target Sets under/over limit value for Check.	Tare Enters/clears a tare value; When the accumulation data is displayed, press to clear them.
Secondary Function (Long Press)	Off If the terminal is On, press to power off.	Units Changes the weighing unit.	Mode Allows changing the application mode.	Menu Enters the user menu.	Target Shows under/over limit value for Check.	Tare Displays the tare weight.
Menu Function (Short Press)	Yes Accepts the current setting on the display.	No Advances to the next menu or menu item. Rejects the current setting on the display and advances to the next available one.	Back Moves back to the previous menu item.	Exit Exits the user menu. Aborts the calibration in progress.		

Notes:

- Short Press: press less than 1 second.
- Long Press: press and hold for more than 2 seconds.

Numeric keyboard (i-DT61XWE)

Primary Function (Short Press)	1-9 Enters numeric values.	. Enters decimal point (.).	0 Enters numeric values 0.	CLR Clears the entered value. Clears an existing APW. When the accumulation data is displayed, press to clear them.
Secondary Function (Long Press)		LIB Searches library items with numeric keys.	User Searches users with numeric keys.	+/- Switches between positive and negative values.

Note: for i-DT61XWE model, press the and button together for three seconds can lock all buttons. Perform the same procedure again to unlock all buttons. When all buttons are locked, the icon will be lighted.

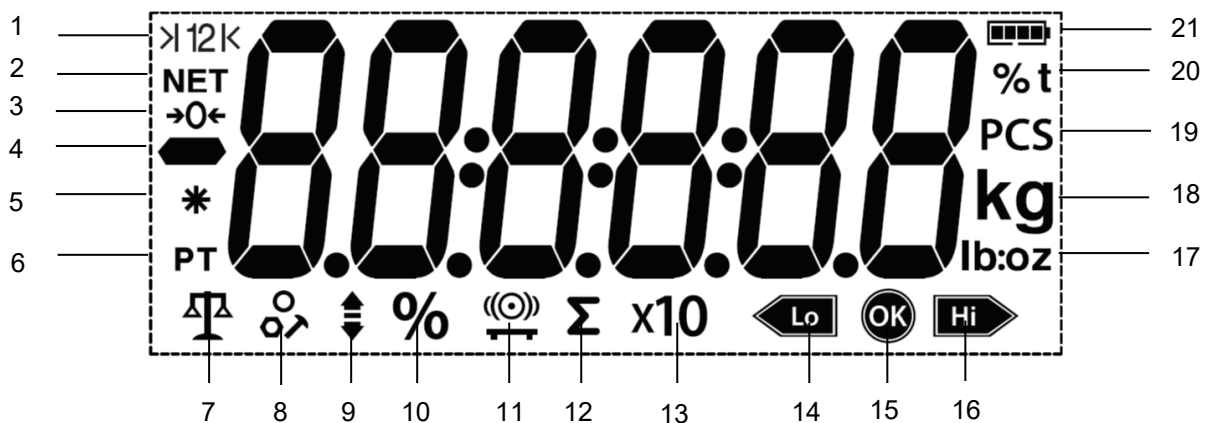

Figure 1-5 i-DT61PW Display

Item	Description	Item	Description
1	Range symbol (not used)	12	Accumulation symbol
2	NET symbol	13	Resolution extension symbol (not used)
3	Center of Zero symbol	14	Check weighing lower symbol
4	Negative symbol	15	Acceptable symbol
5	Stable weight symbol	16	Check weighing higher symbol
6	Preset Tare, Tare symbols	17	Pound, Ounce, Pound:Ounce symbols
7	Weighing mode symbol	18	Kilogram, gram symbols
8	Counting mode symbol	19	Pieces symbol
9	Check weighing mode symbol	20	Percent symbol, tonne symbol (not used)
10	Percentage weighing mode symbol	21	Battery symbol
11	Dynamic weighing mode symbol		



Figure 1-6 i-DT61XWE Display

Item	Description	Item	Description
1	NET symbol	11	Wi-Fi symbol
2	Center of Zero symbol	12	Lock symbol
3	Negative symbol	13	Dynamic (tilde) symbol
4	Stable weight symbol	14	Battery symbol (not use)
5	Preset Tare, Tare symbols	15	Pound, Ounce, Pound:Ounce symbols
6	Pointer symbols	16	Percent symbol
7	ID symbol	17	Kilogram, gram symbols
8	Accumulation symbol	18	Pieces symbol, tonne symbol (not used)
9	Library symbol	19	Scale symbol (not used)
10	User symbol		

2. INSTALLATION

2.1 Unpacking

Unpack the following items:

- i-DT61PW or i-DT61XWE indicator
- 6 cells of D size dry batteries (i-DT61PW only)
- Mounting bracket
- Knobs (2)
- Quick installation guide
- Instruction manual

2.2 External Connections

2.2.1 Scale Base with EasyConnect™ Connector

To connect the OHAUS scale base with EasyConnect™ connector to the terminal, plug the base's connector onto the external load cell connector located at the bottom of the terminal. Then rotate the base connector's locking ring clockwise. Check the following illustration for details.

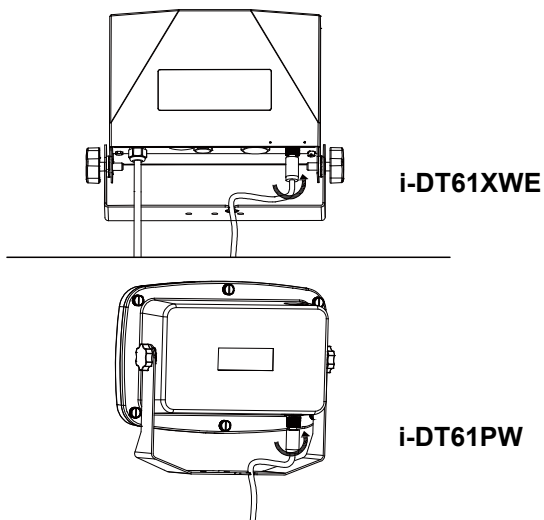

2.2.2 Power input to i-DT61PW

Use 6 cells of D size dry batteries. During battery operation, the battery symbol indicates the battery status.



Battery 5%~25% remaining



Battery 25%~50% remaining



Battery 50%~75% remaining



Battery 75%~100% remaining

2.2.3 AC Power to i-DT61XWE

Connect the AC plug to an electrical outlet.

2.3 Internal Connections

Some connections require the housing to be opened.

2.3.1 Opening the Housing



CAUTION: ELECTRICAL SHOCK HAZARD. REMOVE ALL POWER CONNECTIONS TO THE INDICATOR BEFORE SERVICING OR MAKING INTERNAL CONNECTIONS. THE HOUSING SHOULD ONLY BE OPENED BY AUTHORIZED AND QUALIFIED PERSONNEL, SUCH AS AN ELECTRICAL TECHNICIAN.

i-DT61PW

1. Remove the six Phillips head screws from the rear housing.
2. Remove the front housing. Be careful not to disturb the internal connections.

- Once all connections are made, re-attach the front housing.

i-DT61XWE

- Remove the four hex head screws from the bottom housing.



- Open the housing by carefully pulling the bottom housing backward.

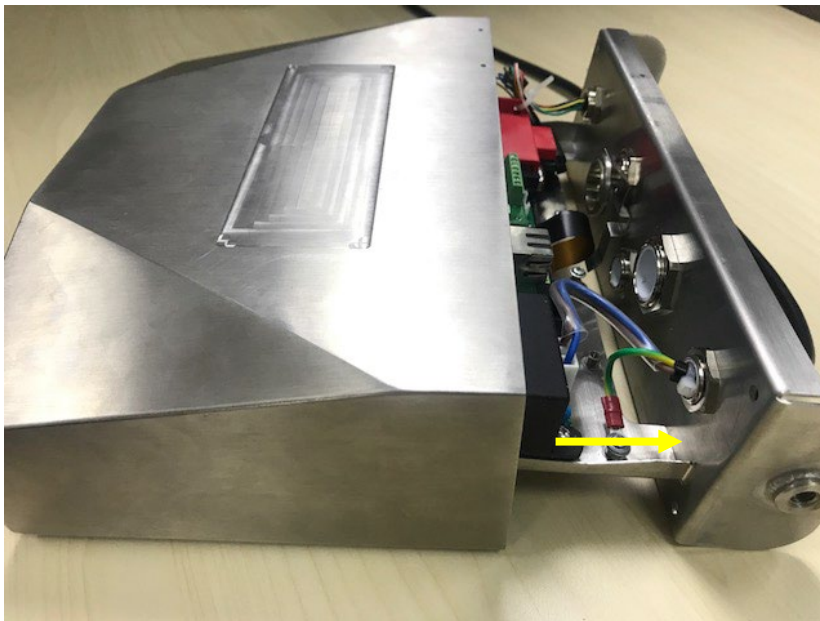

- Once all connections are made, re-attach the bottom housing.

Note: The screws should be tightened to 2.5 N•m (20-25 in-lb) torque to ensure a watertight seal.

2.3.2 Scale Base without EasyConnect™ Connector

For connecting bases (which do not have the EasyConnect™ connector) to an i-DT61PW or an i-DT61XWE, a load cell cable gland kit (P/N 30379716) is available as an accessory.

Removing the pre-installed Load Cell connector and wiring harness.

Before making the connections, remove the pre-installed load cell connector and wiring harness by following the following steps.

i-DT61PW

- Remove the 6 Phillips head screws, and open the rear housing by carefully pulling the front housing forward.

2. Unplug the white load cell connectors from the main housing (two circles).



3. Open the front housing by removing the 12 Phillips head screws.
4. Unplug the white load cell connectors from the main PCBA board.

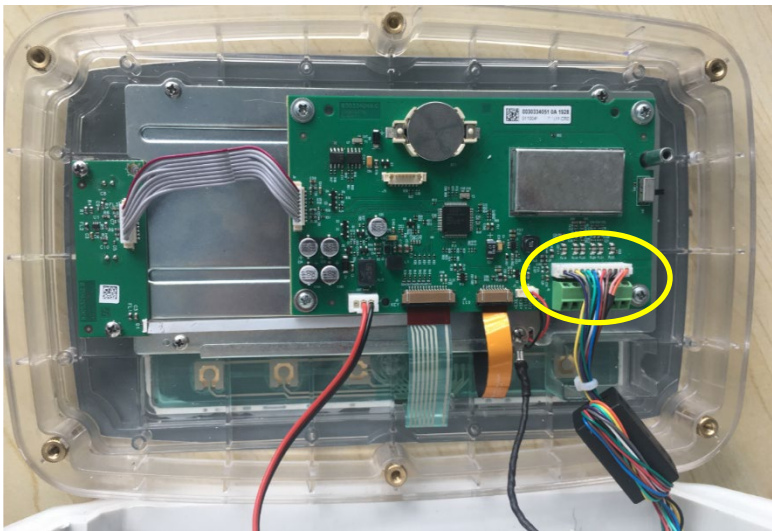

i-DT61XWE

1. Place the terminal down, and unscrew the screws marked in the following graphic.



2. Pull out the bottom of the terminal.

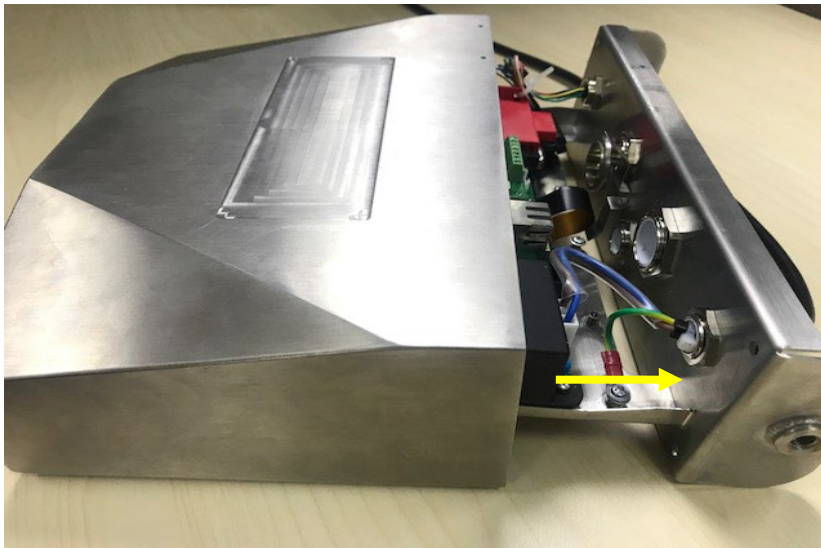

3. Use a screw driver to unscrew the sealing cover.



4. Pull the protruding part of the sealing cover a little forward to release it.



5. Remove the sealing cover and then unplug the white load cell connectors.



Installing Load Cell Cable and Connectors

In order to meet certain electrical noise emission limits and to protect i-DT61PW and i-DT61XWE from external influences, it is necessary to install a ferrite core on the load cell cable connected to the terminal. The ferrite core is included with the terminal.

To install the ferrite, simply route the cable through the center of the core and then take one wrap around the outside of the core and route the cable through the center again. Either the complete cable or the individual wires can be wrapped through the ferrite. This should be done as close to the enclosure as possible. See Figure 2-1.



Figure 2-1

Main Board Wiring Connections

Once the i-DT61PW and i-DT61XWE enclosure is opened, connections can be made to the terminal blocks on the main board as shown in Figure 2-2.

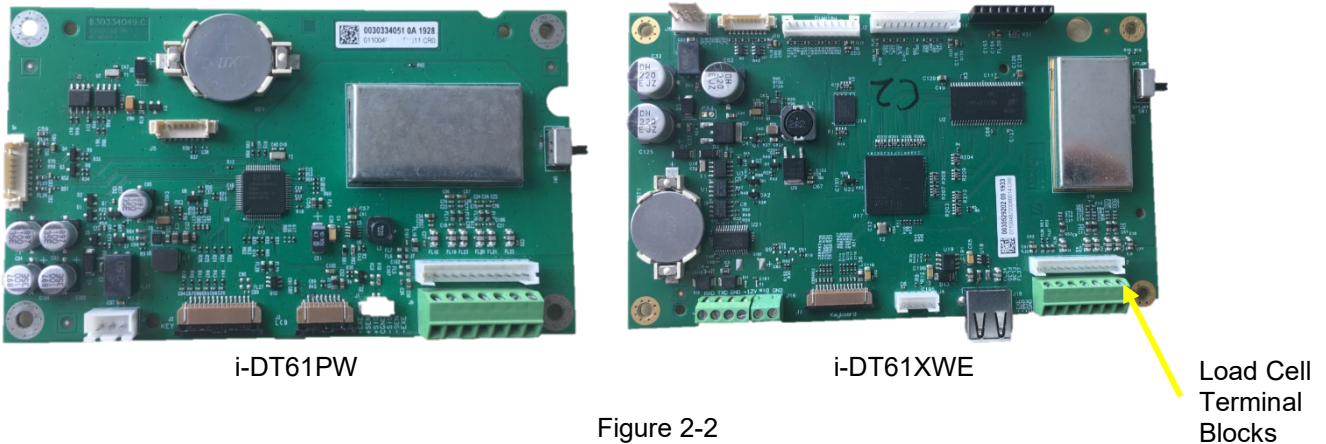
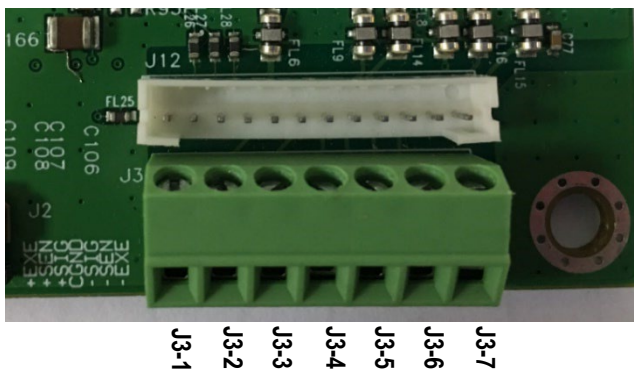

Figure 2-2

Jumper Connections

The i-DT61PW and i-DT61XWE indicators are designed to support both 2mV/V and 3mV/V load cells from the same circuitry. A load cell output rating selection jumper is not required.

Figure 2-3 shows the terminal definitions for the analog load cell terminal blocks. Note that when using four-wire load cells, jumpers must be placed between the +Excitation and +Sense terminals and between the -Excitation and -Sense terminals.



Pin	Connection
J3-1	+EXC
J3-2	+SEN
J3-3	+SIN
J3-4	GND
J3-5	-SIN
J3-6	-SEN
J3-7	-EXC

Figure 2-3 Jumper Connections

After wiring is completed, replace the indicator housing screws. Make sure the water-proof cable gland is properly tightened.

2.3.3 Communication Interface Cable to i-DT61PW

Attach the IR Communication cable (P/N: 30572910) to the indicator front panel, make sure the two holes in the interface cable module match the two bolts which located in the front panel.

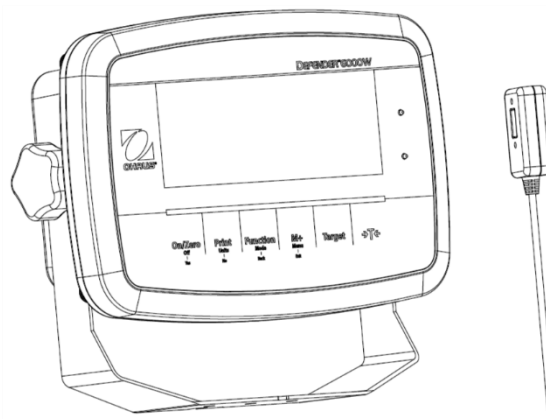

Figure 2-4

2.3.4 RS232 Interface Cable to i-DT61XWE

Pass the optional RS232 cable through the strain relief and attach it to the RS232 connector on the mainboard. Tighten the strain relief to maintain a watertight seal. Please refer to Figure 2-7 for the position of the serial port connector RXD TXD and GND.

Note:

- Please refer to Opening the Housing section for how to open the case of the terminal.
- For details about Discrete Input0 function, please refer to the **Discrete I/O (for i-DT61XWE)** section for details.



Figure 2-5
Strain Relief for Option

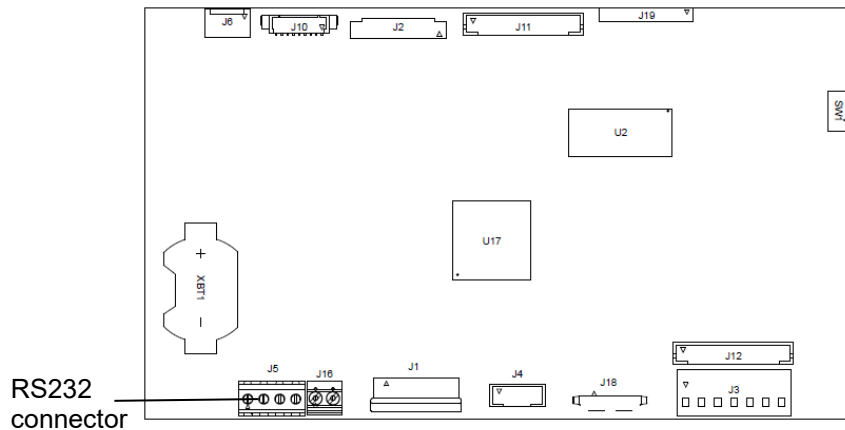

Figure 2-6 RS232 connector on the mainboard

Discrete Input0

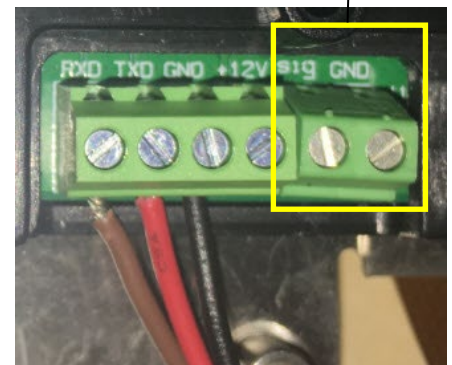

Figure 2-7
RS232 connector

2.4 Mounting

Attach the bracket to a wall or table using fasteners (not supplied) that are appropriate for the type of mounting surface. The bracket will accommodate up to 6 mm (1/4") diameter screws. Locate the mounting holes as shown in Figure 2-8 and 2-9.

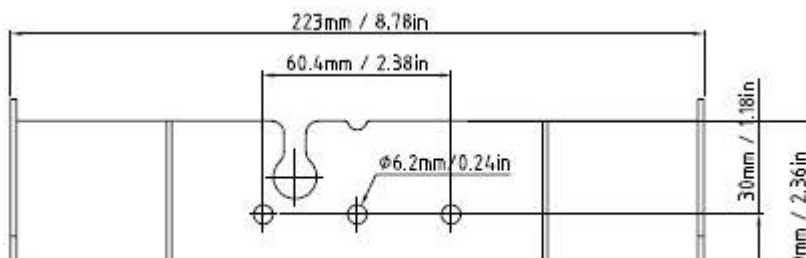

Figure 2-8 i-DT61PW
Mounting Bracket Dimensions

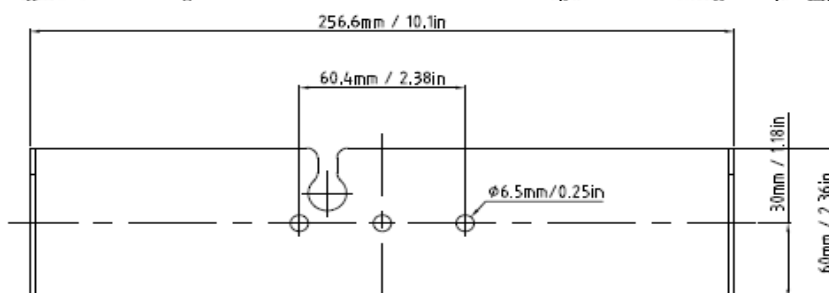

Figure 2-9 i-DT61XWE
Mounting Bracket Dimensions

3. OPERATION

3.1 Turning the Scale On/Off

To turn the scale on, press and hold the **On/Zero Off** button for 1 second. The scale performs a display test, momentarily displays the software version, and then enters the active weighing mode.

To turn the scale off, press and hold the **On/Zero Off** button until **OFF** is displayed.

3.2 Weighing Mode

Use this application to determine the weight of items in the selected unit of measure. This mode is the factory default setting.

3.2.1 Enter the Mode and Start Weighing

To enter the weighing mode from any application mode:

1. Press and hold the **Mode** button until **MODE** is displayed.
2. If needed, place an empty container on the pan and press the  button to tare.
3. Add sample to the pan or container. The display shows the weight of the sample.

Note: Please refer to the **Check** section for how to use Check in the Weighing mode.

3.2.2 Accumulation and Statistics

The Accumulation feature enables manual or automatic totalizing of displayed values. Statistical data (total accumulated weight, min/max weights, pieces, percent, and total number of samples) is stored in memory for review and printing. Accumulation works together with each application mode except Filling, but the accumulation data will be cleared when change to another mode.

3.2.2.1 Settings

There are four accumulation options:

- Off (**OFF**): disable accumulation function.
- Manual (**MANUAL**): press the **M+** button to do accumulation manually.
- Auto (**AUTO**): the scale will perform accumulation automatically.
- Accept (**ACCEPT**): the scale will perform accumulation automatically in the **Check** mode when the weight on the pan is acceptable between the under and over value you set.

To set accumulation options:

1. Long press the **Menu** button until you see **C.A.L.**
2. Short Press the **No** button one time. When you see **S.E.T.U.P.**, press the **Yes** button.
3. Short Press the **No** button several times to navigate until you see **ACCUM**. Press the **Yes** button.
4. Short Press the **No** button several times to select the accumulation option you want. The four options have been introduced above. Then press the **Yes** button to confirm.
5. Press the **Exit** button to exit.

3.2.2.2 Accumulation

Manual

Place the item on the scale and press the **M+** button to add the weight to accumulation. The Σ pointer will keep flashing until the weight is removed and the platform is stable.

Auto

Place the item on the scale. The displayed value is accumulated automatically. The Σ pointer will keep flashing until the weight is removed and the platform is stable.

Accept

Place the item on the scale in check mode. The displayed value is accumulated automatically when the weight is acceptable between the under and over value you set.

3.2.2.3 Viewing and Clearing Statistical Data

When the pan is cleared, press the **M+** button to view the accumulation and statistics results.



To clear the accumulation data, press the **CLR** button on i-DT61XWE terminal or the  button on i-DT61PW terminal while the statistical information is displayed. When the display shows **CLR.ACC**, press the **Yes** button to clear the stored data and return to current mode.

Notes:

- The item must be removed from the pan before the next item can be accumulated.
- Only stable weights are stored.
- Changing modes will clear the stored accumulation data.
- When Legal for Trade is turned ON, for NTEP, gross and net weight cannot be added to the same total. If the first weight is recorded in gross, the future ones should be recorded in the same way. It is the same for net weight.

3.2.3 Check

Use this application to compare the weight of items to a target weight range. This mode is available for Weighing, Counting, Percent, and Dynamic.

3.1.1.1 Set Check Limits

i-DT61PW

1. Press the **Target** button from Weighing, Counting, Percent or Dynamic mode to set check limits.
2. The display shows **Under**.
3. Press the **Yes** button to edit the under value.
4. If there is a stored under value of the last time, the display will show it. For example: 1.0kg.
 - Press the **Yes** button if you want to use this value. Then the display shows **Over**.
 - Press the **No** button if you do not want to use this value, and skip to step 6.
5. If there is no stored value, the display shows **000000**.
6. To set a new under value, short press the **No** button several times until the desired number appears. Short press the **Yes** button to accept the number and move to the next digit. Repeat the process until all the digits are correct. Press the **Yes** button to accept the value. Then the display shows **Over**.
7. Repeat step 2 to 6 to set the over value.
8. If the values you set are invalid, the display will show **--NO--** and go back to reset.
9. If the values you set are valid, the display will go to check weighing screen.

i-DT61XWE

1. Press the **Target** button from Weighing, Counting, Percent or Dynamic mode to set check limits.
2. The display shows **Under**.
3. Press the **Yes** button to edit the under value.
4. If there is a stored under value of the last time, the display will show it.
 - Press the **Yes** button if you want to use this value.
 - Press the **No** button if you do not want to use this value or do not have a stored value. Input the needed one with the numeric keypad. Press the **Yes** button to accept the under value.
5. The display will show **Over**.
6. Repeat step 2 and 3 to set the over value.
7. If the values you set are invalid, the display will show **--NO--** and go back to reset.
8. If the values you set are valid, the display will go to check weighing screen.

3.1.1.2 Positive Check

Positive check is used to determine when the material added to the scale is within the target range. In this case the under and over values must be positive values. (The over value must be greater than the under value.) Add material to the scale platform until the display shows it is within the Accept (green) range.

3.1.1.3 Negative Check

Negative check is used to determine when the material removed from the scale is within the target range. In this case the under and over values are both negative values. The under value must be greater than the over value. (For example: the under value is -10; the over value is -15).



Place the item to be weighed on the scale and press the  button. Remove a portion of the item until it is within the acceptable range.

3.1.1.4 Zero Check

Zero check is used when comparing subsequent samples to an initial reference sample. In this case, the under value must be a negative value and the over value must be a positive one.

Place the reference item on the scale and press the  button.
Remove material from the scale platform until the display shows it is within the Accept (green) range.

3.1.1.5 Clear Check Limits

Long press the **Target** button until the display shows the under and over values.

Press the **CLR** button of i-DT61XWE indicator or the  button of i-DT61PW indicator, the display shows **CLr.CHL**. Press the **Yes** button to clear both the under and over values.

3.1.2 Application Settings

The application can be customized for user preferences.

To enter application settings:

1. Long press the **Menu** button until you see **C.A.L.**. Short press the **No** button several times until you see **00.0.d.E**. Press the **Yes** button to enter the application mode settings.
2. Short press the **No** button several times to navigate until you see the selection you want.
3. Press the **Yes** button to select.
4. Repeat step 2 and 3 several times until you finish all settings.
5. Press the **Exit** button to exit.

The Weighing Configurations are defined below (defaults in Bold).

Item	Available Settings	Comments
Weighing (LWE IGH)	On , Off	To enable Weighing

Note: you cannot disable Weighing if you are in the mode currently.

3.2 Counting Mode

Use this application to count samples of uniform weight.

3.2.4 Enter the Mode

To enter the mode:

1. Press and hold the **Mode** button until **COUNT** is displayed.
2. When the **Mode** button is released, the display shows **CLR.PWJ**.
3. If you need to clear the stored APW of the last time, press the **Yes** button. Then go to **Establish an APW** section.
Note: if the weight on the pan is larger than 1d, the display will show **CLR.PAN** until the weight is removed from the pan.
4. If you need to recall the stored APW of the last time and continue to use it, press the **No** button to start counting.
Note: if no APW has been set before, step 3 and 4 will be omitted.

3.2.5 Establish an APW

To establish an APW:

1. Follow the previous step 4.
 - **i-DT61PW:**
The display shows the sample size **Pwt. 10**. To change it, short press the **No** button several times until you see the value you want.
Note: available sample size selections are 5, 10, 20, 50 and 100 (The default is 10).
 - **i-DT61XWE:**
The display flashes with the current sample size, such as 10 Pcs. To change it, input the new sample size through the numeric keyboard. Do not press the **Yes** button until you finish the next step.
2. Place the specified quantity of samples on the pan and press the **Yes** button to capture the current stable weight.

Note:

- During the capture process, the display shows - - - - . (i-DT61PW)
- You can press the  button to tare. The center of zero, PT or NET icons will light as appropriate.
- If the APW is between 0.1d and 1d, the display shows **LD.rEF** for 1.5 seconds. Then it will start counting.
- If the APW is less than 0.1d, the display shows **rEF.Err** for 1.5 seconds and then return to showing what is displayed on step 1. Please replace the samples on the pan and press the **Yes** button to re-establish an APW value.

3.2.6 Start Counting

1. Place parts on the pan and read the number. The number of pieces and the Pcs icon are displayed.
2. Press the **Function** button to temporarily display the APW. **APWJ** is displayed for 0.5 seconds. Then the APW value is displayed for 1.5 seconds using the current unit of measurement.

Note: Please refer to **Check** in the **Weighing Mode** section for how to use Check in the Counting mode.

3.2.7 Application Settings

The application can be customized for user preferences. Please refer to **Application Settings** section in **Weighing Mode** for details about how to enter application settings.

The Counting Configurations are defined below (defaults in Bold).

Item	Available Settings	Comments
Count (COUNT)	On , Off	To enable Counting
Auto Opt. (A.OPT)	On , Off	Off: Auto Opt. is off. On: The APW will be optimized automatically during count weighing.

Note: you cannot disable Count if you are in the mode currently.

3.3 Percent Mode

Use this application to measure the weight of a sample displayed as a percentage of a pre-established reference weight.

3.3.1 Enter the Mode

To enter the percent mode from any application mode:

1. Press and hold the **Mode** button until **PERCENT** is displayed.
2. When the **Mode** button is released, the display shows **CLR.REF** and the % icon.
3. If you need to clear the stored reference weight of the last time, press the **Yes** button. Then go to step 5.
Note: If captured weight is more than or equal to 1d or is less than or equal to -1d, the display will show **CLR.PAN** until the sample is removed from the pan.
4. If you need to recall the stored reference weight of the last time and continue to use it, press the **No** button and start percent weighing.
Note: If no reference weight has been previously stored, step 3 and 4 will be omitted.
5. The display shows the **PUL.REF** and the % icon.

3.3.2 Establish a Reference Weight

To establish a reference weight:

Follow the previous step 5. When you see **PUL.REF** displayed on the screen, place the specified quantity of samples on the pan and press the **Yes** button to capture the current stable weight.

Note:

- You can press the  button to tare. The center of zero, PT or NET icons will light as appropriate.
- For i-DT61PW model, during the capture process, the display shows - - - - .
- If the reference weight is less than 100d during the capture process, the display will show **REF.Err** for 1.5 seconds and then return to showing **PUL.REF**. Please replace the samples on the pan and press the **Yes** button to re-establish a reference weight.

3.3.3 Start Percent Weighing

1. Place a sample on the pan and read the percent. The current percent value and % icon are displayed.
2. Press the **Function** button to temporarily display the reference weight. **REF.WGT** is displayed for 0.5 seconds. Then the reference weight value is displayed for 1.5 seconds in the current unit of measurement.

Note: Please refer to **Check** in the **Weighing Mode** section for how to use Check in the Percent Weighing mode.

3.3.4 Application Settings

The application can be customized for user preferences. Please refer to **Application Settings** section in **Weighing Mode** for details about how to enter application settings.

The Percent Weighing Configurations are defined below (defaults in Bold).

Item	Available Settings	Comments
Percent (PERCENT)	On , Off	To enable Percent Weighing

Note: you cannot disable Percent if you are in the mode currently.

3.4 Dynamic Mode

Use this application to weigh an unstable load, such as a moving animal.

3.4.1 Enter the Mode

To enter the Dynamic Weighing Mode from any application mode:

1. Press and hold the **Mode** button until **DYNAMIC** is displayed.
2. The display shows **READY**.

3.4.2 Start Dynamic Weighing

1. To start:
 - When operation type is manual. Place the load (more than or equal to 5d) on the pan and press the **Function** button to start the averaging process.

- When operation type is semi-automatic/automatic. Place the load (more than or equal to the Start Weight) on the pan, and the terminal will start averaging process automatically
Note: The display must be at zero gross or net value before placing the load on the pan.
- During the averaging period, the countdown timer decreases in one second increments (For example, the set average time is 5s).
Note: If the set average time is 0s, the countdown timer is not displayed.
 - The readings are averaged and held on the display when the countdown has completed in both Countdown and Continuous mode.
In addition, for DT61XWE model:
 - The tilde symbol will blink indicating that the current weight is being held in Countdown Mode.
 - The tilde symbol will blink indicating that the current weight is being averaged in real time in Continuous Mode.**Note:** If the set average time is 0s, the first weight larger than 5d will be displayed and hold.
 - To reset the countdown timer:
 - When the operation type is manual/semi-automatic, press the **Function** button to reset the countdown timer when the countdown is running. The display shows **rEAdY**, and start to re-count.
 - When operation type is automatic, remove the load from the pan, and the average weight will still be displayed until the duration time is over. Then the display shows **rEAdY**, and start to re-count.**Note:**
 - The **rEAdY** display must be at zero gross or net value in order to reset the countdown timer.
 - Please refer to **Check** in the **Weighing Mode** section for how to use Check in the Dynamic Weighing mode.

3.4.3 Application Settings

The application can be customized for user preferences. Please refer to **Application Settings** section in **Weighing Mode** for details about how to enter application settings.

The Dynamic Weighing Configurations are defined below (defaults in Bold).

Item	Available Settings	Comments
Dynamic Mode (ԺՄՈՒՆՈՒՄ)	Countdown (Հ.ԺՈՆԱՄ) / Continues (ՀՅՈՒՆ)/ Off (ՕՖՖ)	Count down: There is a countdown time. Continuous: Averaging will be continued after the countdown time.
Dynamic Operation Type (Ժ.ԷՎՊԵ)	Manul (ՄԱՆԱԼ) / Semi-auto (ՏԵՄԻ ՎՈՒՄ)/ Auto (ՔԱՎՏՈՒՄ)	Manual: The averaging process is started and reset manually. Semi-auto: The averaging process is started automatically and reset manually. Auto: The averaging process is started and reset automatically.
Start Weight (Տ.ԵՆՍՈՒՄ)	0 ~ Capacity Weight	Dynamic weighing will start when the load is bigger than the start weight (for Semi-auto and Auto mode).
Duration Time (Ժ.Է ԻՐԴԵ)	1 ~ 10 s	It is the time for the display to remain the dynamic weighing result after the load is removed.
Average Time (Ք.Է ԻՐԴԵ)	0 ~ 30 s	Time in Seconds. If the average time is 0, the first stable weight (more than or equal to 5d) will be the result.

Note: you cannot disable Dynamic if you are in the mode currently.

3.5 Filling Mode

Use this application to fill a container to a pre-determined target weight.

Note: filling mode is only available for i-DT61XWE model.

3.5.1 Enter the Mode

To enter the Filling mode from any application mode:

- Press and hold the **Mode** button until **F ILL** is displayed.
- The actual weight is displayed on the display.

3.5.2 Start Filling

- 1 When the scale is in stop or pause status, press the **Function** button to start filling process. The output port will be enabled.
- 2 Add weight on the pan. When one set point (SP1/SP2/SP3/SP4) is reached, the related output port will be disabled.
- 3 When the scale is in start or pause status, press the **Function** button to stop filling process. The output port will be all disabled.

3.5.3 Resume and Pause Filling

- 1 When the scale is in pause status, press the **Target** button to resume the filling process. The output port will be enabled or disabled according to the current load value.
- 2 When the scale is in start status, press the **Target** button to pause the filling process. The output port will be all disabled, and the display will be frozen.

3.5.4 Display of the Dot Matrix Screen

The Dot Matrix Display will be divided into one to four columns according to how many set points (SP) are valid. The maximum is four columns. For example, if you set four SPs, then the screen will be divided into four columns. In addition, the screen will display different colors according to the load value.

For example:

1. You set four valid SP values and SP1 is less than SP2, SP2 less than SP3, SP3 less than SP4. Then the screen will be divided into four columns.

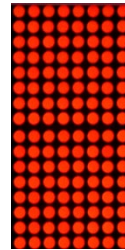

2. To start filling, if the first load is less than SP1, the first column displays orange, and others red.

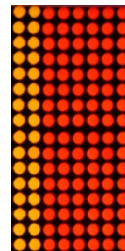

3. If continue to fill the second time, and the total load is now more than or equal to SP1 while less than SP2, the first column displays green, the second orange, and others red.

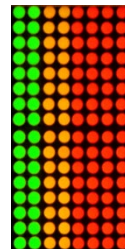

4. After that to fill the third time, if the total load is now more than or equal to SP2 while less than SP3, the first two columns display green, the third orange, and others red.

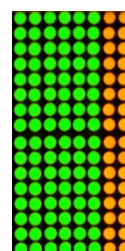
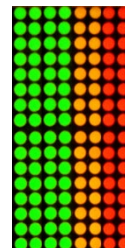

5. To load the fourth time, if the total load is now more than or equal to SP3 while less than SP4, the first three columns display green, and the fourth one orange.

6. Nevertheless, if the total load is more than SP4, all the four columns turn to red and the instrument will be in a stop state.

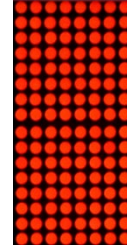

3.5.5 Application Settings

The application can be customized for user preferences. Please refer to **Application Settings** section in **Weighing Mode** for details about how to enter application settings.

The Filling Configurations are defined below (defaults in Bold)

Item	Available Settings	Comments
Filling (F ILL)	On , Off	To enable Filling Weighing

Note: you cannot disable Filling if you are in the mode currently.

4. MENU SETTINGS

The User Menu allows the customizing of scale settings.

Note: Additional Sub-Menus may be available if Interface Options are installed. See Interface User Manual for the additional setting information.

4.1 Menu Navigation

4.1.1 User Menu

For i-DT61PW model

C.A.L	S.E.t.U.P	r.E.A.d	MO.d.E	U.n. it	G.M.P	A.S.2.3.2	P.r. I.N.t	L.o.c.t	End
ZE-rD	rESEt	rESEt	rESEt	rESEt	rESEt	rESEt	rESEt	rESEt	
SPAN	C.UN it	StAbLE	WJE IGH	kg	d.FMnE	bAUd	ASS IGH	L.ALL	
L INE	CAP	ZE-rD	COUNt	g	dAbE	PAR itY	StAbLE	L.OFF	
GEO	GrAd	F ILtEr	R.OPt	lb	t.FMnE	StOP	MOdE	L.ZE-rD	
C.t.ESt	P.ZE-rD	R2t	PE-rCnE	oz	t INnE	H.SHARtE	t INnE	L.Pr INt	
End	P.UN it	b.L IGHt	dYnARn	lb;oz	P. Id	ALt.P	C.SUMn	L.UN it	
	A.tArE	S.SAUEr	d.tYPE	End	S. Id	ALt.t	tEPMn	L.MOdE	
	ACCUMn	R.OFF	d.t INnE		End	ALt.2	End	L.MnENU	
	t.CnE	P.SAUER	A.t INnE			End		L.tArE	
	t.NEMt	End	End					L.tArGE	
	End							End	

For i-DT61XWE model

C.A.L	S.E.t.U.P	r.E.A.d	MO.d.E	U.n. it	G.M.P	A.S.2.3.2	P.r. I.N.t	I.O.	L.o.c.t	L. I.b	U.S.E.r	U.S.b	End
ZE-rD	rESEt	rESEt	rESEt	rESEt	rESEt	rESEt	rESEt	rESEt	rESEt	NEW	NEW	rESEt	
SPAN	C.UN it	StAbLE	WJE IGH	kg	d.FMnE	bAUd	ASS IGH	tYPE	L.ALL	Ed it	Ed it	tYPE	
L INE	rANGE	ZE-rD	PE-rCnE	g	dAbE	PAR itY	StAbLE	INPUt 1	L.OFF	End	End	E.MnENU	
GEO	CAP 1	F ILtEr	dYnARn	lb	t.FMnE	StOP	MOdE	INPUt2	L.ZE-rD			I.MnENU	
C.t.ESt	GrAd 1	R2t	d.tYPE	oz	t INnE	H.SHARtE	t INnE	OUt 1	L.Pr INt			E.L Ib	
End	CAP2	L IGHt	S.LUt	lb;oz	P. Id	ALt.P	C.SUMn	OUt2	L.UN it			I.L Ib	
	GrAd2	S.SAUEr	d.t INnE	End	S. Id	ALt.t	tEPMn	OUt3	L.FUNC			E.USER	
	P.ZE-rD	R.OFF	A.t INnE		End	ALt.2	End	OUt4	L.MOdE			I.USER	
	P.UN it	L.tEY	F ILL			End		End	L.MnENU			LENGtH	
	A.tArE	End	End						L.tArE			S.d IG it	
	ACCUMn								L.tArGE				
	t.bEEP								End				
	t.CL ICH												
	bP.S IG												
	L.S IGH												
	Ir.FUNC												
	Ir.AdJ												
	t.CnE												
	t.NEMt												
	PLUd.EN												
	PLUd												
	End												

Notes:

Some modes/units may not be available in all models.

When LEGAL FOR TRADE is turned **ON** (the lock switch is in the locked position), the menu settings will be affected as below:

- Calibration (C.A.L) menu is not accessible.

- Zero Range setting is locked at 2%.
- Stable Range setting is locked at 1d.
- Auto-Zero Tracking setting is locked at 0.5d.
- Filter and Units are locked at their current settings.
- Stable Only is locked to be **On**.
- Auto Print/Continuous is disabled.
- Lb;oz unit is locked Off.

4.1.2 Button Navigation

- The **Yes** button: allows entry into the displayed menu.
Accepts the displayed setting and advances to the next item.
- The **No** button: rejects entry into the displayed menu.
Rejects the displayed menu and move on to the next selection.
- The **Back** button: moves backwards through the upper and middle level menus.
Backs out of a list of selectable items to the previous middle level menu.
- The **Exit** button: exits from menu directly to the active weighing mode.

For menu items with numeric settings such as Capacity, the current setting is displayed with all digits flashing. To revise:

1. Press the **No** button to begin editing.
2. The first digit is displayed flashing.
3. Press the **No** button to increase the digit or press the **Yes** button to accept the digit and move to the next one.
4. Repeat this process for all digits.
5. Press the **Yes** button when the last digit has been set.
6. The new setting is displayed with all digits flashing. Press the **Yes** button to accept the setting or press the **No** button to resume editing.
7. To end the current menu selection, press the **Yes** button to advance to the next menu, or press the **No** button to return to the top of the current menu.

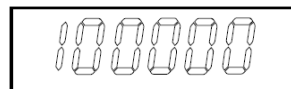
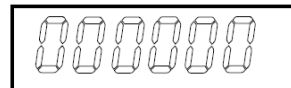

Note: For i-DT61XWE model, the numeric value can be input by the numeric keypad directly.

4.2 Calibration Menu

Enter this menu to perform calibrations.

4.2.1 Initial Calibration

When the scale is operated for the first time, a zero and span calibration are recommended to ensure accurate weighing results.

Before performing the calibration, be sure to have the appropriate calibration weights as listed in table 4-1. Ensure that the LFT switch/calibration lock is set to the unlocked position.

Or adjust the GEO setting according to your location.

TABLE 4-1

Required Span Calibration Mass (sold separately)			
Max	Mass*	Max	Mass*
3000g	3kg / 5lb	30000g	30kg / 50lb
6000g	6kg / 10lb	60000g	60kg / 100lb
15000g	15kg/25lb	150000g	150kg / 250lb

Note:

- When active unit is g or kg, the calibrating unit will be in kg.
- When active unit is lb, oz or lb:oz, the calibrating unit will be in lb.
- For linearity calibration, the calibration Mass is fixed. The Mid-point is always half of the full capacity.

4.2.2 Zero Calibration [ZE-0]

Zero calibration uses one calibration point. The zero calibration point is established with no weight on the scale. Use this calibration method to adjust for a different static load without affecting the span or linearity calibration.

Calibration procedures:

1. Long press the **Menu** button until you see **C.A.L.** Press the **Yes** button.
2. The display shows **ZE-0**. Press the **Yes** button.
3. The display flashes **0** kg and the calibration unit. With no weight on the pan, press the **Yes** button to establish the zero point.
4. The display shows **--C--**, and then **-DONE-** when the Zero calibration is finished.

Note:

If zero calibration is failed or if after 40 seconds the calibration is still not successful, **CAL E** is displayed for 3 seconds and the previous calibration data is restored. The scale exits to the active weighing mode and displays the actual weight value in the current weighing unit.

5. Then the display shows **SPAN**. Press the **Exit** button to exit.

4.2.3 Span Calibration [SPAN]

Span calibration uses one point. The span calibration point is established with a calibration mass placed on the scale.

Note: Span calibration should be performed after zero calibration.

Calibration procedures:

1. Long press the **Menu** button until you see **C.A.L.** Press the **Yes** button.
2. Short press the **No** button to navigate until you see **SPAN**. Press the **Yes** button.
3. The display flashes with the calibration point and calibration unit based on the capacity and unit set in the capacity menu. (e.g. **030.000** kg). If you do not need to change the calibration point, skip to step 5.
4. To change the calibration point:
 - i-DT61PW: short press the **No** button several times until the desired digit appears. Short press the **Yes** button to accept the digit and move to the next one. Repeat the process until all the digits are correct. Press the **Yes** button to accept the calibration point. The display flashes with the calibration point you set.
 - i-DT61XWE: input the calibration point through the numeric keys. (Do not press the **Yes** button until you finish step 5.)
5. Place a calibration mass of the specified weight on the pan and press the **Yes** button.
6. The display shows **--C--**, and then **-DONE-** when the calibration is finished.

7. Then the display shows **L 0n**. Press the **Exit** button to exit.

Note:

- If calibration is failed, **CAL E** is displayed for 3 seconds and the previous calibration data is restored. The scale exits to the active weighing mode and displays the actual weight value in the current weighing unit.
- If after waiting for 40s the calibration is still not successful, **CAL E** is displayed for 3 seconds and the previous calibration data is restored. The scale exits to the active weighing mode and displays the actual weight value in the current weighing unit.

4.2.4 Linearity Calibration [**L 0n**]

Linearity calibration uses 3 calibration points. The full calibration point is established with a weight on the scale. The mid calibration point is established with a weight equal to half of the full calibration weight on the scale. The zero calibration point is established with no weight on the scale. The full calibration and mid calibration points can be altered by the user during the calibration procedure.

Calibration procedures:

1. Long press the **Menu** button until you see **C.A.L.** Press the **Yes** button.
2. Short press the **No** button several times to navigate until you see **L 0n**. Press the **Yes** button.
3. The display flashes with **0** kg and the calibration unit. With no weight on the pan, press the **Yes** button to establish the zero point.
4. The display shows **--[]--**, and then moves to flash with the first calibration point and calibration unit based on the capacity and unit you set in the capacity menu. (For example, **0 15.000** kg). If you do not need to change the calibration point, skip to step 6.
5. To change the calibration point:
 - i-DT61PW: short press the **No** button several times until the desired digit appears. Short press the **Yes** button to accept the digit and move to the next one. Repeat the process until all the digits are correct. Press the **Yes** button to accept the calibration point. The display flashes with the calibration point you set.
 - i-DT61XWE: input the calibration point through the numeric keys. (Do not press the **Yes** button here until you finish step 6).
6. Place a calibration mass of the specified weight on the pan and press the **Yes** button.
7. The display shows **--[]--**, and then moves to flash with the second calibration point and calibration unit based on the capacity and unit you set in the capacity menu. (For example, **030.000** kg).

Note:

If after waiting for 40s the calibration is still not successful, **CAL E** is displayed for 3 seconds and the previous calibration data is restored. The scale exits to the active weighing mode and displays the actual weight value in the currently selected weighing unit.

8. Repeat step 5 and 6.
9. The display shows **--[]--**, and then **-DONE-** when the Linearity calibration is finished.
10. Then the display shows **GEO**. Press the **Exit** button to exit.

4.2.5 GEO Adjustment [**GEO**]

Geographical Adjustment Factor (GEO) is used to adjust the calibration based on the current location. Settings from 0 to 31 are available with 12 being the default.

Please refer to the **Table of Geo Values** section in the **Technical Data** chapter to determine the GEO factor that corresponds to your location.

To set the GEO factor:

1. Long press the **Menu** button until you see **C.A.L.** Press the **Yes** button.
2. Short press the **No** button several times to navigate until you see **GEO**. Press the **Yes** button.
3. The display flashes with the Geo point (For example, **12**).
4. Short press the **No** button several times until the desired GEO number appears. Press the **Yes** button to finish setting.
5. Then the display shows **C.L.E.S.E.** Press the **Exit** button to exit.

4.2.6 Calibration Test [C.L.E5E]

Calibration test procedures:

1. Long press the **Menu** button until you see **C.A.L.** Press the **Yes** button.
2. Short press the **No** button several times to navigate until you see **C.L.E5E**. Press the **Yes** button.
3. The display flashes with **0** and the calibration unit based on the capacity and unit you set in the capacity menu. With no weight on the pan, press the **Yes** button to establish the zero point.
4. The display shows **--E--** while the zero point is recorded.
5. The display flashes with the calibration weight and the unit of the last time. (For example, **0 15.000 kg**).
6. To change the test calibration weight:
 - i-DT61PW: short press the **No** button several times until the desired digit appears. Short press the **Yes** button to accept the digit and move to the next one. Repeat the process until all the digits are correct. Press the **Yes** button to accept the calibration point.
 - i-DT61XWE: press the numeric keys to edit the weight. (Do not press the **Yes** button here until you finish step 7).
7. Place the specified test weight on the pan and press the **Yes** button.
8. The display flashes with the difference between the calibration data and the test weight. (For example, **0.0 10 kg**). If the terminal is connected to a printer or other devices, the result of the Calibration Test will be printed.
9. After 5 seconds, the test ends and the scale returns to the active weighing mode with the display of the current weight.

4.2.7 End Cal [End]

When **End** is displayed, press the **Yes** button to exit this menu and advance to the next Sub-menu or press the **No** button to advance to the first menu item in the this Sub-menu.

4.3 Setup Menu

Enter this menu **S.E.E.U.P** to set scale parameters. Default settings are in **bold**.

For i-DT61PW model

Menu	Sub-Menu	Sub-Menu (in segment)	Options	Options (in segment)
Setup S.E.E.U.P	Reset	rE5Ee	no, yes	NO, YES
	Capacity Unit	C.UNIt	kg, lb, t, g	/
	Capacity	CRP	1-999999	/
	Graduation	GrAd	0.0001~100	/
	Power On Zero	P.ZEro	Off, On	OFF, ON
	Power On Unit	P.UNIt	Auto , g, kg, lb, oz, lb:oz, t	AUTO
	Auto Tare	A.tArE	Off, On, Accept	OFF, ON, ACCEPT
	Accumulation	ACCUMn	Off, Auto, Manual, Accept	OFF, MAN, AUTO, ACCEPT
	Transaction Counter	t.Cnt	Off, On	OFF, ON
	Next Transaction	t.NEXT	1-999999	/
	End	End	\	/

For i-DT61XWE model

Menu	Sub-Menu	Sub-Menu (in segment)	Options	Options (in segment)
Setup S.E.E.U.P	Reset	rE5Ee	no, yes	NO, YES
	Capacity Unit	C.UNIt	kg, lb	/
	Range	rRANGe	Single , Dual	SINGLE, DUAL
	> 1 < Capacity	CRP 1	1-999999	/
	> 1 < Graduation	GrAd 1	0.0001~100	/

> 2 < Capacity [Range=Dual]	CAP2	1-999999	/
> 2 < Graduation [Range=Dual]	GrAd2	0.0001~100	/
Power On Zero	P.ZERO	Off, On	OFF, ON
Power On Unit	P.ON U	Auto, g, kg, lb, oz, lb:oz	AUTO
Auto Tare	A.TARE	Off, On, Accept	OFF, ON, ACCEPT
Accumulation	ACCUM	Off, Auto, Manual, Accept	OFF, MAN, AUTO, ACCEPT
Key Beep	K.BEEP	Off, On	OFF, ON
Key Click Type	K.CLICK	single, double	SINGLE, DOUBLE
Check beep signal	CB.SIG	off, under, over, accept, under-over	OFF, UNDER, OVER, ACCEPT, UN-OV
Check light signal	LSIGN	block, bar, segment	BLOCK, BAR, SEGMENT
IR Func	IR.FUNC	Disp, Zero, Tare, Print	DISP, ZERO, TARE, PRINT
IR Adjust	IR.Adj	OFF, LOW, HI	OFF, LOW, HI
Transaction Counter	T.CNT	Off, On	OFF, ON
Next Transaction	T.NEXT	1-999999	/
PasswordEnable	PWD.EN	Off, On	OFF, ON
End	End	\	

Reset [rESEt]

Reset the Setup menu to factory defaults.

no = do not reset

YES = reset

Capacity Unit [C.UN t]

Select the unit used for calibration.

t (Metric Tonne)

g

kg

lb

Note: t and g are not available for i-DT61XWE model.

Range [rRNGE]

Note: This setting is only available for i-DT61XWE model.

Set the number of weighing intervals.

This terminals can be configured to use single or dual interval. Each interval can be assigned its own graduation. If dual interval is selected, the graduation will change when the weight reaches the second interval.

When **Single** interval is selected, the additional parameters available are:

>|1|< Capacity

>|1|< Graduation

When **Dual** interval is selected, the terminal functions with two intervals, each with its own capacity and graduation. In addition to the Interval 1 capacity and graduation parameters, the following two parameters are available:

>|2|< Capacity

>|2|< Graduation

Capacity [CAP] / Capacity1 [CAP 1]

Set the capacity of the scale or the capacity of the first scale (for i-DT61XWE model).

1...999999

Grad [GrAd] / Grad1 [GrAd 1]

Set the scale readability or the readability of the first scale for i-DT61XWE model from 0.0001 to 100.

0.0001~100

Capacity2 [CAP2]

Set the capacity of the second scale for i-DT61XWE model.

Grad2 [GrAd2]

Set the readability of the second scale for i-DT61XWE model.

Power On Zero [P.ZEr0]

Zero the scale at Power On.

OFF = disabled.

ON = enabled.

Power On Unit [P.UN t]

Set the unit that will be displayed at Power On.

Auto = last unit in use when turned off

kg = kilograms

g = grams

lb = pounds

oz = ounces

lb:oz = pound ounces

t = metric tonne (only available for i-DT61PW model)

Auto Tare [A.TARE]

Set the automatic tare functionality.

OFF = automatic tare is disabled.

ON = the first stable gross weight is tared.

ACCEPT = stable gross weights within the acceptable limits are tared (in Check mode).

Accumulation [ACCUM]

Set the accumulation functionality.

OFF = accumulation is disabled.

AUTO = perform accumulation automatically.

MAN = perform accumulation manually.

ACCEPT = perform accumulation when weights are within the acceptable limits (in Check mode).

Note: For details about accumulation, please refer to **Accumulation and Statistics** in **Weighing Mode** section.

Transaction Counter [T.CNT]

The transaction counter is a seven-digit counter that tracks the total transactions. When the value reaches 9,999,999, the next transaction causes a roll-over to 0000001.

OFF = the transaction counter will not increase.

ON = the transaction counter will increase with the additional menu item Next Transaction available.

Note: If the transaction counter is set to be ON, the count number will increase when press the **Print** button.

Next Transaction Counter [T.NEXT]

Set the value of the next transaction displays in the Next Transaction field.

1~999999

Key Beeper [T.BEEP]

Set whether the beeper is enabled when a button is pressed.

OFF = no sound

ON = sound

Note: This setting is only available for i-DT61XWE model.

Key Click Type [T.CL ICT]

SINGLE = single click the button to execute operation.

DOUBLE = double click the button to execute operation.

Note: This setting is only available for i-DT61XWE model.

Beeper Signal [BP.S IG]

Set the condition for beeper sound in Check Weighing mode.

OFF = the beeper is disabled.

UNDER = the beeper sound is enabled when the weight is below the under value you set.

OVER = the beeper sound is enabled when the weight is above the over value you set.

ACCEPT = the beeper sound is enabled when the weight is within the acceptable range you set.

ON-OV = the beeper sound is enabled when the weight is below the under value or above the over value you set.

Note: This setting is only available for i-DT61XWE model.

Check Light signal [L.S IG]

Set how the display shows in Check mode for over, under and acceptable weight.

BLOCK = the light is shown in block.

BAR = the light is shown in bar.

SEGMENT = the light is shown in segment.

Note: This setting is only available for i-DT61XWE model.

IR Function [Ir.FUNC]

Define the operation for the Infrared Radiation Sensor.

ZERO = the scale performs zero operation equal to pressing the **Zero** button.

TARE = the scale performs tare operation equal to pressing the  button.

PRINT = the scale performs print operation equal to pressing the **Print** button.

DISPLAY = turns on the backlight.

Wave you hand before the  icon on the control panel to perform the operation you set.

Note: This setting is only available for i-DT61XWE model.

IR Adjust [Ir.Adj]

Define the response distance of the Infrared Radiation Sensor.

OFF = the IR sensor is disabled.

LOW = the sensor will respond within 50mm/2 inches.

HIGH = the sensor will respond within 100mm/4 inches.

Note: This setting is only available for i-DT61XWE model.

Password Enable [PLWd.En]

Define if you need password to enter menu. When is it turned on, you need to input the password each time you enter menu.

OFF = to disable password function.

ON = to enable password function.

Password [PLWd]

This sub-menu will only appear when Password Enable menu is selected to be on.

The display flashes with **_**, input the new password through the numeric keyboard. Press the **CLR** button to change your inputs. Press the **Yes** button when you finish.

End Setup [End]

Advance to the next menu or return to the top of the current menu.

4.4 Readout Menu

Enter this menu to set user preferences. Default settings are in **bold**.

Menu	Sub-Menu	Sub-Menu (in segment)	Options	Options (in segment)
Read Out (r.E.R.d)	Reset	rESEt	no, yes	NO, YES
	Stability	StAbLE	0.5d, 1d , 2d, 5d	0.5d, 1d , 2d, 5d
	Zero Range	ZER0	2%, 100%	2, 100
	Filter Level	FILtEr	Low, Medium , High	LOW, MEd , HIGH
	Auto Zero Track	AZt	Off, 0.5d , 1d, 3d	OFF, 0.5d, 1d , 3d
	Bright Level (i-DT61XWE)	LIGHt	Low, Medium , High	MEd , HIGH, LOW
	Back Light (i-DT61PW)	b.LIGHt	Off , On, Auto	OFF , ON, AuT0
	Screen	ScRnEr	Off, 1min, 2min, 5min (i-DT61PW) Off, 5min, 10min, 30min (i-DT61XW)	OFF, 1, 2, 5 (i-DT61PW) OFF, 5, 10, 30 (i-DT61XW)
	Auto Off	A.OFF	Off , 5min, 10min, 30min	OFF , 5, 10, 30
	P.SAVE (i-DT61PW)	P.SAVEr	ON , OFF	ON , OFF

	L.KEY (i-DT61XWE)	L.FEY	Off, 0.5min, 1min, 2min, 5min	OFF, 0.5, 1, 2, 5
	End	End	\	

Reset [RESEt]

Reset the readout menu to factory defaults.

- NO** = do not reset.
YES = reset

Stability [StAbLE]

Set the amount the reading can vary before the stability symbol turns off.

- 0.5d** = 0.5 scale division
1d = 1 scale division
2d = 2 scale division
5d = 5 scale division

Zero [ZER0]

Set the percentage of scale capacity that may be zeroed.

- 2%** = zero range is +/-2%
100% = zero range is +/-100%

Filter [F ILtEr]

Set the amount of signal filtering.

- LOW** = faster stabilization time with less stability.
NEd = normal stabilization time with normal stability.
HIGH = slower stabilization time with more stability.

AZT [AZt]

Set the automatic zero tracking functionality.

- OFF** = disabled
0.5d = the display will maintain zero until a change of 0.5 divisions per second has been exceeded.
1d = the display will maintain zero until a change of 1 divisions per second has been exceeded.
3d = the display will maintain zero until a change of 3 divisions per second has been exceeded.

Bright Level [L IGHE]

Set the display bright level.

L0L0 = bright Level is low

00Ed = bright Level is medium

H IGX = bright Level is high

Note: This setting is only available for i-DT61XWE model.

Backlight [b.L IGHE]

Set the display backlight functionality.

OFF = backlight is disabled.

ON = backlight is enabled.

RUt0 = backlight is disabled after 5 seconds of no activity.

Note: This setting is only available for i-DT61PW model.

Screen [ScREEN]

Set whether the screensaver is enabled after the selected time period.

For i-DT61PW:

OFF = screensaver is disabled

1 = the screensaver is enabled after 1 minute of no activity.

2 = the screensaver is enabled after 2 minute of no activity.

5 = the screensaver is enabled after 5 minute of no activity.

For i-DT61XWE:

OFF = screensaver is disabled

5 = the screensaver is enabled after 5 minute of no activity.

10 = the screensaver is enabled after 10 minute of no activity.

30 = the screensaver is enabled after 30 minute of no activity.

Lock Key [LKEY]

Set to lock all keys after the selected time period.

OFF = disabled

0.5 = keys are locked after 30 seconds of no activity.

1 = keys are locked after 1 minutes of no activity.

2 = keys are locked after 2 minutes of no activity.

5 = keys are locked after 5 minutes of no activity.

Auto Off [A.OFF]

Set whether the display enters sleep mode after the selected time period.

OFF = disabled

5 = the display enters sleep mode after 5 minute of no activity.

10 = the display enters sleep mode after 10 minute of no activity.

30 = the display enters sleep mode after 30 minute of no activity.

P.SAVE [P.SAVER]

Set whether to enable power saving mode after the scale enters standby mode.

ON = power saving is enabled.

OFF = power saving is disabled.

Note: this setting is only for i-DT61PW model.

End Readout [End]

Advance to the next menu or return to the top of the current menu.

4.5 Unit Menu

Enter this menu **U.U. 1.1** to activate the desired units.

Reset
 Gram (g)
 Kilogram (kg)
 Pound (lb)
 Ounce (oz)
 Pound:Ounce (lb:oz)
 Tonne (t) (only available for i-DT61PW model)
 End

Note:

- Due to national laws, the indicator may not include some of the units listed.
- If the Security Switch is turned on, the Units are locked at their current setting.
- Available units vary by model and local regulations.

4.6 GLP/GMP Menu

Enter this menu to set the Good Laboratory Practice (GLP) or Good Manufacturing Practice (GMP) data.

Reset [**rE5E1**]

If Reset is selected and confirmed, all the submenu value will be set to default.

Data Format [**d.F111**]

Set the date format.

MDY [**111dY**] = Month.Day.Year

DMY [**d111Y**] = Day.Month.Year

YMD [**Y111d**] = Year.Month.Day

Date [**d111E**]

Set the date according to the previous Date Format you set.

For example, you set YMD (Year. Month. Day) for the Date Format, and the data you are going to input is 2020/4/17.

Then set the date as: 20.04.17 (Year. Month. Day)

Time Format [**t.F111**]

Set the time format.

24 hr = 24 hour format.

12 hr = 12 hour format.

Time [**t.111E**]

Set the time.

24 hour format

00 to 23 = hour position

00 to 59 = minute position

12 hour format:

00 to 12 = hour position

00 to 59 = minute position

For how to input the number of the time, please refer to the following project ID section for details.

Note: for i-DT61XWE model, you cannot use the numeric keyboard to input the time.

Project ID [P. Id]

Set the Project identification number.

To set the number, short press the **No** button several times until the desired number appears. Short press the **Yes** button to accept the number and move to the next digit. Repeat the process until all the digits are correct. Press the **Yes** button to accept the value.

For i-DT61XWE model, you can input the Project ID through the numeric keyboard.

Scale ID [5. Id]

Set the scale identification.

Please refer to the **Project ID** section about how to set the number.

For i-DT61XWE model, you can input the Scale ID through the numeric keyboard.

End [End]

Advance to the next menu or return to the top of the current menu.

4.7 Communication

Enter this menu to define external communication methods and to set printing parameters.

Data may be output to either a printer or PC.

Factory default settings are shown in bold.

4.7.1 RS232 Menu

Enter this menu to define communication parameters.

Note: 2nd RS232 is only available for i-DT61XWE model.

Menu	Sub-Menu	Sub-Menu (in segment)	Options	Options (in segment)
RS232 (r.5.2.3.2) 2nd SERIAL PORT (2.5.E.r. 1A)	Baud Rate	bAUd	300, 600, 1200, 2400, 4800, 9600 , 19200, 38400, 57600	/
	Parity	PAR ITY	7 Even, 7 Odd, 7 None, 8 None	7 E <u>VEN</u> , 7 O <u>DD</u> , 7 <u>NONE</u> , 8 NONE
	Stop Bit	StOP	1 bit , 2 bit	/
	Handshake	H.SHAKE	None , Xon/Xoff	NONE , <u>ONOFF</u>
	Alt Print CMD	ALt.P	'A' ~ 'Z', P	/
	Alt Tare CMD	ALt.t	'A' ~ 'Z', T	/
	Alt Zero CMD	ALt.z	'A' ~ 'Z', Z	/
	Reset	rESEt	\	/
End	End	\	/	

Reset [rESEt]

Reset the RS232 menu to factory defaults.

nO = do not reset.

YEs = reset

Baud Rate [bAUd]

Set the baud rate (bits per second).

300 = 300 bps

600 = 600 bps

1200 = 1200 bps

2400 = 2400 bps

4800 = 4800 bps

9600 = 9600 bps

19200 = 19200 bps

38400 = 38400 bps

57600 = 57600 bps

Parity [PARITY]

Set the data bits and parity.

- 7 **EVEN** = 7 data bits, even parity
- 7 **ODD** = 7 data bits, odd parity
- 7 **NONE** = 7 data bits, no parity
- 8 **NONE** = 8 data bits, no parity

Stop bit [STOP]

Set the number of stop bits.

- 1 = 1 stop bits
- 2 = 2 stop bits

Handshake [HANDSHAKE]

Set the flow control method. Hardware handshaking is only available for COM1 menu.

- NONE** = no handshaking
- ONOFF** = XON/XOFF software handshaking

Alternate Print command [ALTP]

Set the alternate command character for Print.

Settings of A (a) to Z (z) are available. The default setting is **P**.

Alternate Tare command [ALT]

Set the alternate command character for Tare.

Settings of A(a) to Z(z) are available. The default setting is **T**.

Alternate Zero command [ALTZ]

Set the alternate command character for Zero.

Settings of A (a) to Z (z) are available. The default setting is **Z**.

End [End]

Advance to the next menu or return to the top of the current menu.

4.7.2 Print Menu

Enter this menu to set printing parameters. Default settings are **bold**.

Menu	Sub-Menu	Sub-Menu (in segment)	Options	Options (in segment)
Print (P.r. 1, 2, 1) 2nd Print (P.r. 1, 2, 2)	Assignment	ASSIGN	Demand , Auto On Stable, Auto On Accept, Interval(seconds), MT-Continuous, OH-Continuous, SICS	DEMAND , ON.StAb, ON.ACCEP, INTER, OH.CON, OH.CON, SICS
	Stable Weight Only [Demand]	StABLE	Off , On(LFT Force On)	OFF , ON
	Mode [Auto On Stable]	MOdE	Load , Load and Zero	LOAD , LOAD:2r
	Time [Interval (seconds)]	TIME	1~50000	/
	Checksum [MT-Continuous]	CHECK	On, Off	ON, OFF
	Template	TEMP	Simple , Custom 1, Custom 2, Custom 3, Custom 4, Custom 5	SIMP , CUS1, CUS2, CUS3, CUS4, CUS5
	Reset	RESET	\	/
	End	End	\	/

Reset [ᄁᄂᄂᄂ]

Reset the Print menu to factory defaults.

ᄁᄁ = do not reset.

ᄂᄂ = reset

Assignment [ᄂᄂᄂᄂᄂ]**Demand [ᄂᄂᄂᄂᄂᄂ]**

If **Demand** is selected, the sub-menu **Stable Only** will display.

Set the printing criteria.

ᄁᄁᄁ = values are printed immediately, regardless of stability.

ᄁᄂ = values are printed only when the stability criteria is met.

Auto On Stable [ᄁᄂ.ᄂᄂᄂᄂ]

If **Auto On Stable** is selected, the sub-menu **Mode** will display.

Set the printing mode.

ᄁᄂᄂᄂ = prints when the displayed load is stable.

ᄁᄂᄂᄂ.ᄂᄂ = prints when the displayed load and zero reading are stable.

Auto On Accept [ᄁᄂ.ᄂᄂᄂᄂᄂ]

If **Auto On Accept** is selected and the weighing mode is **Check**, values will be printed when the weight is accepted.

ᄁᄂ.ᄂᄂᄂᄂᄂ = printing occurs each time the display is within the acceptable range and stability criteria is met.

Interval [ᄂᄂᄂᄂᄂ]

If **Interval** is selected, the sub-menu **Time** will display.

ᄂᄂᄂᄂᄂ = printing occurs at the defined time interval.

The time interval can be set through the numeric keypad (i-DT61XWE) .

Settings of 1 to 50000 seconds are available. Default is 1.

Printing occurs at the defined time interval.

MT-Continuous [ᄂᄂᄂᄂ.ᄂᄂᄂᄂ]

If **MT-Continuous** is selected, the print output will be in the **MT-Continuous** format.

ᄂᄂᄂᄂ.ᄂᄂᄂᄂ = printing occurs continuously.

Note: Refer to Appendix A for **MT-Continuous** format.

ᄂ.ᄂᄂᄂᄂᄂ

Off = disabled

On = enabled

OH-Continuous [ᄁᄂᄂ.ᄂᄂᄂᄂ]

If **OH-Continuous** is selected, the print output will be in the **OH-Continuous** format.

Note: Refer to Appendix A for **OH-Continuous** format.

ᄁᄂᄂ.ᄂᄂᄂᄂ = printing occurs continuously.

SICS [ᄂᄂ ᄂᄂᄂ]

ᄁᄁᄁ = disable MT-SICS command

ᄁᄂ = enable MT-SICS command

Note: Refer to Appendix B for **SICS** commands.

End Print [ᄂᄂᄂᄂ]

Advance to the next menu or return to the top of the current menu.

Template [ᐅᐅᐅᐅ]

This sub-menu is used to define the format of the data output to a printer or computer.

- ᐅᐅᐅᐅ** = only prints result and unit
- ᐅᐅᐅᐅ 1** = customized printout format.
- ᐅᐅᐅᐅ 2** = customized printout format.
- ᐅᐅᐅᐅ 3** = customized printout format.
- ᐅᐅᐅᐅ 4** = customized printout format.
- ᐅᐅᐅᐅ 5** = customized printout format.

Print template example :

- 0.000 kg
- 0.300 kg G
- 0.000 kg N
- 0.100 kg T

To customize print template, you need to go to the ScaleMate software, Select **Print Template** on the top bar, and then double click items in the left column to select which ones you want to put in your print template.

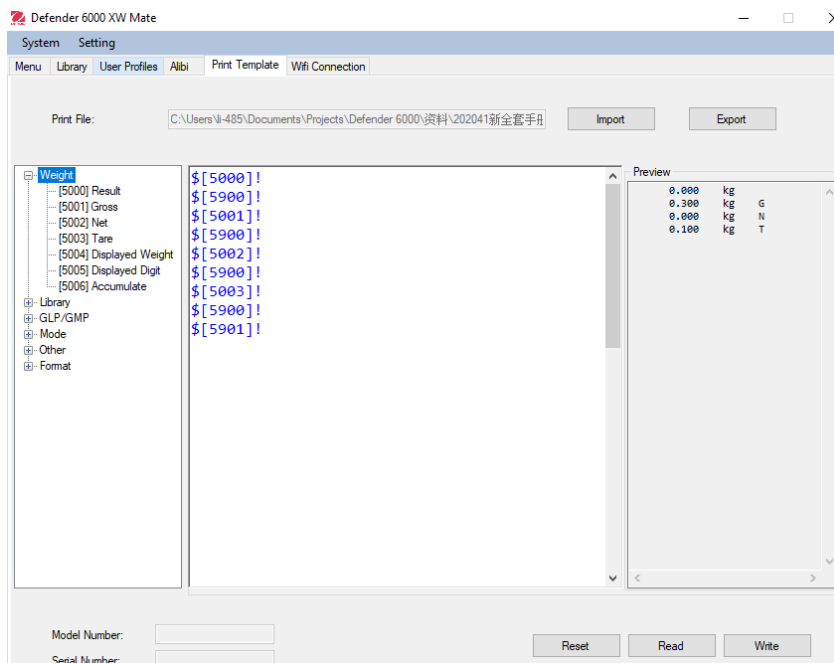

Alternatively, you can also input the items in the middle column directly to customize, using $\$[XXXX]!$ format. XXXX refers to the index number of each print item, please check the following table for each item's index number.

Index Number	Print Items
5000	Result
5001	Gross
5002	Net
5003	Tare
5004	Displayed Wt
5005	Displayed Digit
5006	Accumulate
5100	ID
5101	PN
5102	Lib Name
5200	Date
5201	Time
5202	Project ID

5203	Scale ID
5204	User ID
5205	User Name
5206	Transaction ID
5300	Mode
5301	Information
5302	Target
5400	Alibi ID
5401	Input Status
5402	Output Status
5403	SN
5900	NewLine
5901	End

Note: For ScaleMate's other functions, please contact an authorized dealer to obtain the software's instruction.

4.7.3 Printouts

Printout string for g, kg, lb, oz units:

Check Weighing application:

Field	Weight (Right aligned)	Space	Unit (Right aligned)	Space	Stability (?)	Space	T/N/G/PT (Right aligned)	Space	Application Status (Right aligned)	Term.
Length	11	1	5	1	1	1	2	1	6	2

Non-Check Weighing application:

Field	Weight (Right aligned)	Space	Unit (Right aligned)	Space	Stability (?)	Space	T/N/G/PT (Right aligned)	Term.
Length	11	1	5	1	1	1	2	2

Each field is followed by a single delimiting space (ASCII: 32).

Definitions:

Weight - Up to 11 characters, right justified, - at immediate left of most significant character (if negative).

Unit - Up to 5 characters, right justified. If the Unit in the Print Content menu was set to OFF, the unit will be removed in the weight string and replaced by spaces.

Stability - "?" character is printed if not stable. If weight is a space is printed.

T/N/G/PT - "T" is printed for a tare weight, "N" printed if weight is net weight, 'G' or nothing printed if weight is a gross weight, 'PT' is printed if the tare weight is Pre-set Tare.

Application Status (for Check) – Fixed to 6 characters. Display status like " Under", "Accept" and "Over" for check weighing.

Terminating Character(s) - terminating character(s) printed depending on FEED menu setting.

Printout string for the lb:oz unit.

Field	Weight1	Space	Unit1	Space	Weight2	Space	Unit2	Space	Stability	Space	G/N	Space	Message	Term.Char(s)
Length	4	1	2	1	7	1	2	1	1	1	1	1	5	2

- The printout string has a fixed length of 28 characters.
- Each Space field is a delimiting space used to separate the other fields.
- The Weight1 field is 4 right justified characters. If the value is negative, the ' - ' character is located at the immediate left of the most significant digit.
- The Unit1 field is 2 left justified characters.
- The Weight2 field is 7 right justified characters.
- The Unit2 field is 2 left justified characters.

- The Stability field is 1 character. A space is printed if the weight value is stable. A '?' is printed if the weight value is not stable.
- The G/N field is 1 character. 'G' is printed for a gross weight. 'N' is printed for a net weight.
- The Message field is 5 left justified characters.

Note: The Termination Characters Carriage Return and Line Feed are appended to the printout.

4.7.4 RS485 Configuration

Please refer to RS485 Configuration in the *Defender® 6000 RS232/RS485/USB Interface Instruction Manual*.

4.7.5 Ethernet Configuration

Please refer to Configuration in the *Defender® 6000 Ethernet Interface Instruction Manual*.

4.7.6 Analog Configuration

Please refer to Analog Configuration in the *Defender® 6000 Analog Kit Instruction Manual*.

4.8 Memory

The Memory menu is different for i-DT61PW and i-DT61XWE. Please check the following sections for details.

4.8.1 Memory menu (for i-DT61PW model)

Status [STATUS]

To enable or disable the memory function.

OFF = to disable memory function.

ON = to enable memory function. Press the **Print** button to save weighing data.

Export [EXPORT]

To export weighing data.

NO = to export weighing data function is disabled.

YES = to export weighing data function is enabled.

Delete [DELETE]

To delete weighing data.

NO = to not delete weighing data

YES = to delete weighing data

4.8.2 USB memory (for i-DT61XWE model)

USB memory is used to store the weight readings for future reference. By connecting a USB flash drive to the scale the weight readings can now be stored directly on the USB flash drive.

Note: this menu is only visible after a USB flash drive is detected.

The data will be stored in the flash drive in the following location:

SYSTEM\DATA

A new file will be created monthly (one txt file stores a whole month's output data...). The name of the txt file will be year plus month.TXT. For example, the name of the txt file for 2020.6 will be **202006.TXT**.

To enable USB memory:

1. After you insert a USB flash drive, long press the **Menu** button until you see **C.R.L.**
2. Short press the **No** button several times to navigate until you see **17.E.17.0**. Press the **Yes** button.
3. Short press the **No** button to navigate until you see **USB**. Press the **Yes** button.
4. The display flashes with **ON**. Press the **Yes** button to enable.
5. Sub-menu Link to (**L IN**) appears. Press the **Yes** button to enable.
6. Then the sub-menu appears with selections of RS232 (**r S232**), 2nd Serial (**2.5E r IA**) and Ethernet (**E.E.H.N.E.E**). Choose the one you want and press the **Yes** button.
7. The display shows **End**. Press the **Yes** button. The display shows the next menu. Press the **Exit** button to exit.

4.8.3 Alibi Memory (for i-DT61XWE model)

Note: This menu is only visible if the Alibi memory hardware option has been installed. See below for installation instructions.

Alibi memory is used to store the weight history for reference. Each Alibi record contains the following:

- ID
- Gross /Net weight, tare weight and weight unit
- Date and time

To check Alibi records, you need to install the ScaleMate software. Please contact an authorized dealer to obtain the software

The maximum number of record is 262112.

When the memory is full and another record is stored, the first record will automatically be deleted. At this time a warning message will appear, asking for the user's confirmation.

4.8.3.1 Enable Alibi

To enable:

1. After you install the hardware, long press the **Menu** button until you see **Σ.A.L.**
2. Short press the **No** button several times to navigate until you see **Π.Ε.Π.Ο.** Press the **Yes** button.
3. Short press the **No** button to navigate until you see **AL ib 1.** Press the **Yes** button.
4. The display flashes with **ON.** Press the **Yes** button to enable Alibi.
5. The display shows **END.** Press the **Yes** button. The display shows the next menu **L. 1.b.** Press the **Exit** button to exit.

4.8.3.2 Install Alibi

To install:

1. Power off and unplug the terminal. Disconnect the terminal with a weighing pan if it is connected to one.
2. Place the terminal down, and unscrew the screws marked in the following graphic.



3. Pull out the bottom of the terminal.

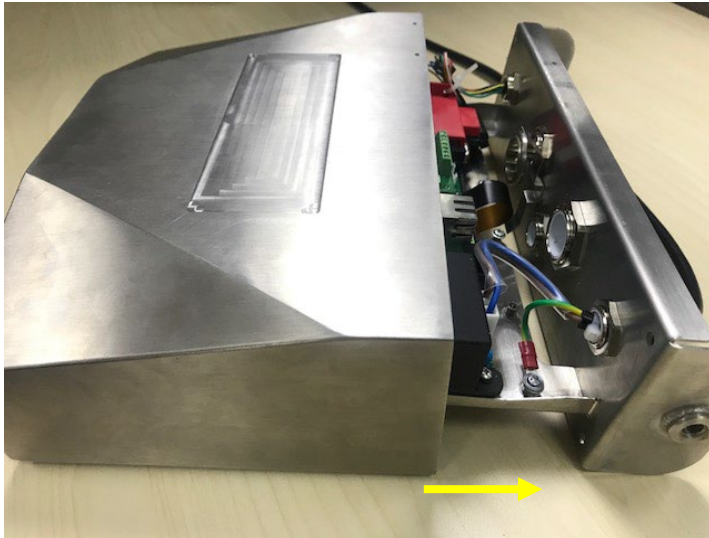

4. Take out the Alibi memory board and prepare to install it in the circled place.

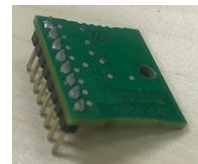

5. Insert the Alibi memory board into the slot as shown below. Please make sure the pins are properly inserted.

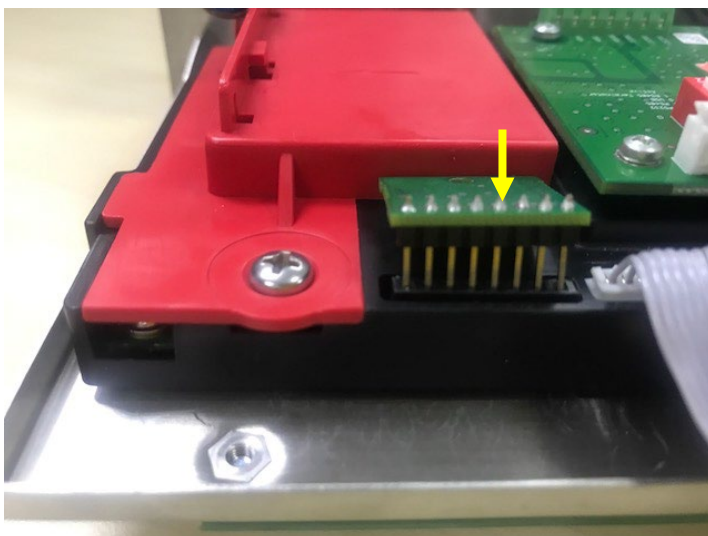

6. Use a screwdriver to tighten the screw and make sure the Alibi memory board is installed properly.

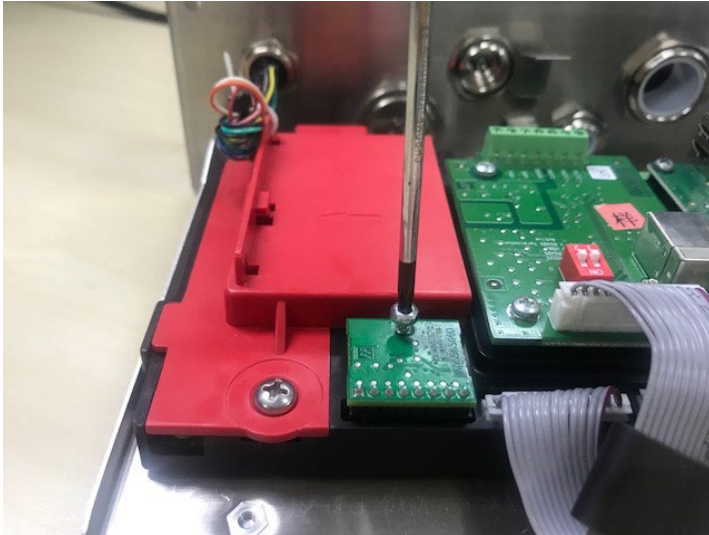

7. Pull the bottom of the terminal in, and make sure all the screws marked in step 2 are tightened.

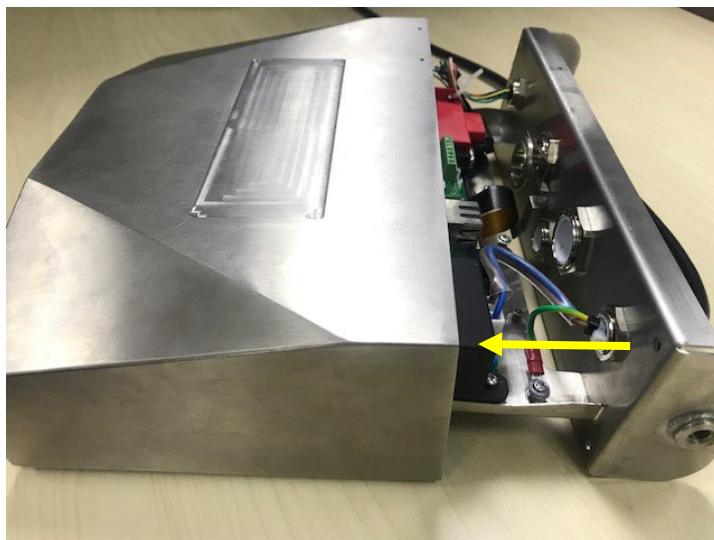

Note:

There is possibility that the button cable is detached from the bottom of the terminal when you pull it out. In that case, please follow the following steps to re-attach the button cable:

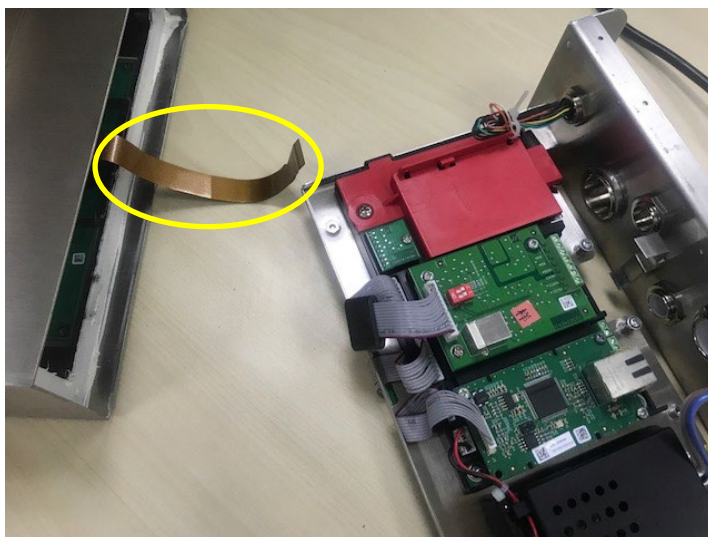

1. When you finish to install the Albi memory board, pass the button cable through the bottom of the meter.

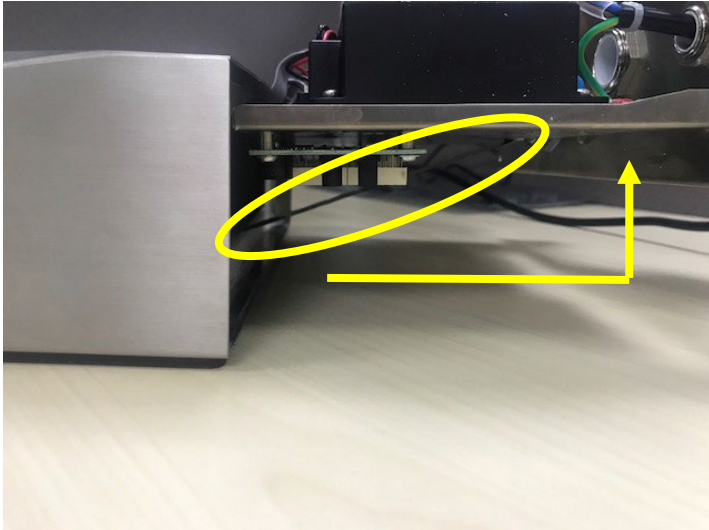

2. And pull it under the FPC socket. Push the button cable further under the FPC socket so that the cable is firmly attached.

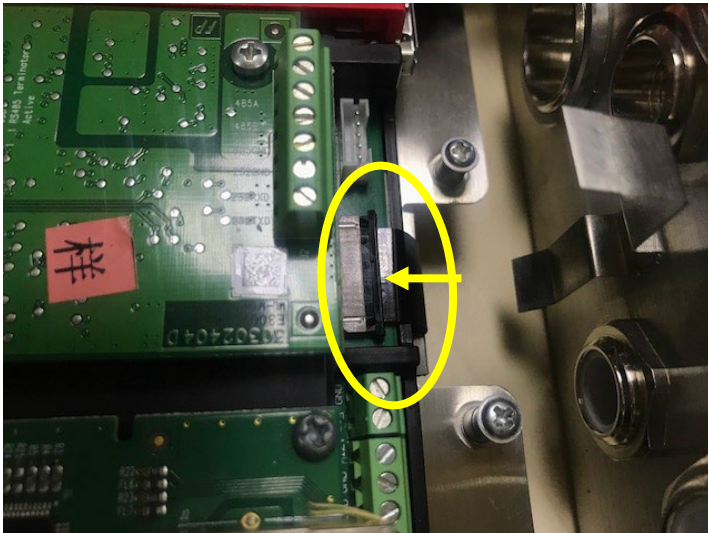

3. Use a tweezers or other tools to pull the right and left side of the FPC socket in.

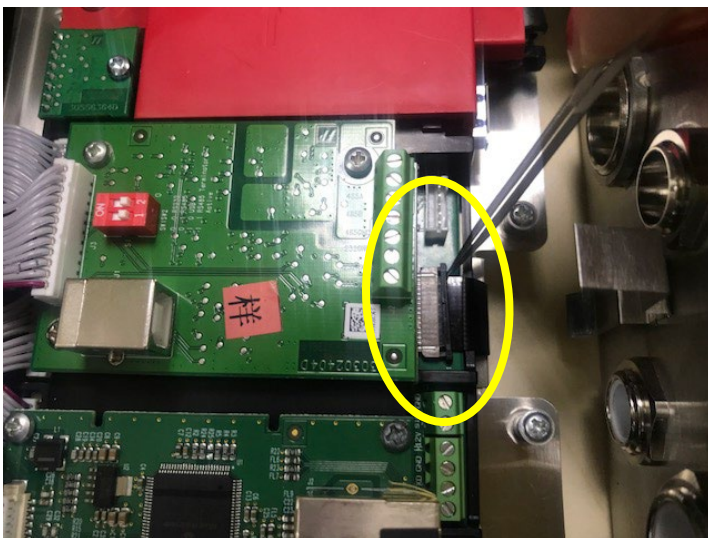

4. Make sure the whole FPC socket are pushed in and the button cable is attached to it firmly.

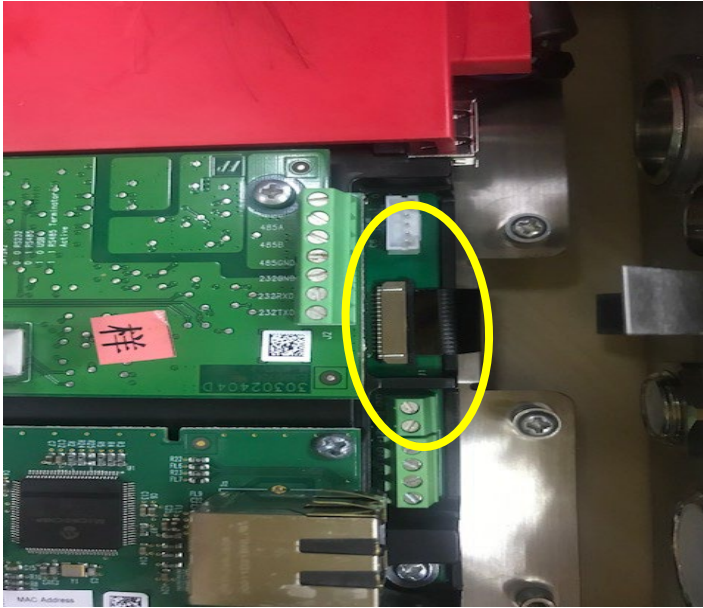

5. Repeat the previous step 7 to push in the bottom of the terminal and tighten all the screws.

4.9 Discrete I/O (for i-DT61XWE model)

Discrete I/O menu allows the configuration of 3 inputs and 4 outputs. The Discrete Input0 is located at J16 on the mainboard (please refer to the **Mainboard** section for where it is located), while other Discrete Inputs & Outputs are located at the Discrete I/O optional board.

Menu	Sub-Menu	Sub-Menu (in segment)	Options	Options (in segment)
I.O. I.O.	Reset	rESEt	no, yes	NO, YES
	TYPE	TYPE	OPEN, CLOSED	OPEN, CLOSED
	Discrete Input0	INPUT0	Off, Zero, Tare, Clear Tare, Print, Unit, Accumulate, Start, Reset, Start/Stop, Pause/Resume	OFF, ZERO, TARE, CLr.TAR, Pr INt, UN It, ACCUMn, StARt rESEt, StA-SP, PA-rE
	Discrete Input1	INPUT 1	Off, Zero, Tare, Clear Tare, Print, Unit, Accumulate, Start, Reset, Start/Stop, Pause/Resume	OFF, ZERO, TARE, CLr.TAR, Pr INt, UN It, ACCUMn, StARt rESEt, StA-SP, PA-rE
	Discrete Input2	INPUT2	Off, Zero, Tare, Clear Tare, Print, Unit, Accumulate, Start, Reset, Start/Stop, Pause/Resume	OFF, ZERO, TARE, CLr.TAR, Pr INt, UN It, ACCUMn, StARt rESEt, StA-SP, PA-rE
	Discrete Output1	OUT 1	Off, Overload, Underload, Over, Under, Accept, Under/Over, SP1, SP2, SP3, SP4, Alarm	OFF, OULOAD, UNLOAD, oUEr, UNdEr, ACCEPt, UN-OU, F.SP 1, F.SP2, F.SP3, F.SP4, ALARn
	Discrete Output2	OUT2	Off, Overload, Underload, Over, Under, Accept, Under/Over, SP1, SP2, SP3, SP4, Alarm	OFF, OULOAD, UNLOAD, oUEr, UNdEr, ACCEPt, UN-OU, F.SP 1, F.SP2, F.SP3, F.SP5, ALARn
	Discrete Output3	OUT3	Off, Overload, Underload, Over, Under, Accept, Under/Over, SP1, SP2, SP3, SP4, Alarm	OFF, OULOAD, UNLOAD, oUEr, UNdEr, ACCEPt, UN-OU, F.SP 1, F.SP2, F.SP3, F.SP5, ALARn
	Discrete Output4	OUT4	Off, Overload, Underload, Over, Under, Accept, Under/Over, SP1, SP2, SP3, SP4, Alarm	OFF, OULOAD, UNLOAD, oUEr, UNdEr, ACCEPt, UN-OU, F.SP 1, F.SP2, F.SP3, F.SP5, ALARn
	End	End	\	/

4.9.1 I/O Type

Set the status of the relay output.

OPEN = the initial state of the relay output is normally open.

CLOSEd = the initial state of the relay output is normally closed.

4.9.2 Input

The input I/O's function is defined below.

OFF	The input connection is disabled.
ZEr0	The external input initiates a Zero function
tArE	The external input initiates a Tare function
CLr.tAr	The external input initiates a Clear Tare function
Pr INt	The external input initiates a Print function
UN tE	The external input initiates a Unit function
ACCUMn	The external input initiates an Accumulate function
StArE	The external input initiates a Start function
rESEt	The external input initiates a Reset function
StAr-SP	The external input initiates a Start function, the second external input initiates a Stop function.
PR-rE	The external input initiates a pause function, the second external input initiates a resume function.

4.9.3 Output

OFF	The output connection is disabled.
OU.LORd	If the weight is overloaded, the instrument will perform a relay output.
UN.LORd	If the weight is underloaded, the instrument will perform a relay output.
oVER	If the weight is above the over value you set, the instrument will perform a relay output.
UNdEr	If the weight is below the under value you set, the instrument will perform a relay output.
ACCEPT	If the weight is within the acceptable range you set, the instrument will perform a relay output.
UN-OU	The weight value is below the under value or above the over value you set, the instrument will perform a relay output.
F.SP1	The weight value is >=SP1, the instrument will perform a relay output.
F.SP2	The weight value is >=SP2, the instrument will perform a relay output.
F.SP3	The weight value is >=SP3, the instrument will perform a relay output.
F.SP4	The weight value is >=SP4, the instrument will perform a relay output.

4.10 Lock Key Configuration
This menu L.O.C is

used to lock access to certain keys. When you select ON for one selection, the associated key press will be ignored.

If you select Lock All Keys, you will lose function of all keys. To unlock, long press the **Menu** key for 30 seconds to enter the settings to unlock it.

Item	Available Settings (bold is the default settings)
Lock All Keys [L.ALL]	OFF, ON
Lock Off Key [L.OFF]	OFF, ON
Lock Zero Key [L.ZEr0]	OFF, ON
Lock Print Key [L.Pr INt]	OFF, ON
Lock Unit Key [L.UN tE]	OFF, ON
Lock Mode Key [L.MOdE]	OFF, ON
Lock Menu Key [L.MENU]	OFF, ON
Lock Tare key [L.tArE]	OFF, ON
Lock Target key [L.tArGE]	OFF, ON
Lock Numeric Key [L.NUMn]	OFF, ON
Reset	NO, YES

Note: If the **Menu** key has been locked, long press the **Menu** key for 30 seconds to enter the settings to unlock it.

4.11 Library (for i-DT61XWE model)

The library supports up to 400 records. The application modes share one library.

The Library can be cloned through below methods:

1. Copy all files to a USB device.
2. Use ScaleMate software (version 2.3.0 or higher) to read all files in the Library. Please contact an authorized dealer to obtain the software.

Directory

Library	I-DT61XWLIB
---------	-------------

Library Items

The libraries have several items PN, Name, Tare, Under, Over, Reference weight, APW, F.SP1, F.SP2, F.SP3 and F.SP4

PN (**PN**): The part number of the material (unique).

Name (**NAME**): The name of the material.

Under (**Under**): The under limit of the check.

Over (**Over**): The over limit of the check.

Tare (**TARE**): The tare weight of the material.

Reference weight (**REF.WGT**): the reference weight for Percent weighing.

APW(**APW**): the average piece weight of for Counting.

F.SP1 (**F.SP 1**): the first target weight for Filling.

F.SP2 (**F.SP2**): the second target weight for Filling.

F.SP3 (**F.SP3**): the third target weight for Filling.

F.SP4 (**F.SP4**): the forth target weight for Filling.

Each weighing mode supports different items. See the table below:

Item Mode	PN	Name	Under	Over	Tare	Reference weight	APW	F.SP1	F.SP2	F.SP3	F.SP4
Weighing	X	X	X	X	X						
Percent	X	X	X	X	X	X					
Dynamic	X	X	X	X	X						
Fill	X	X			X			X	X	X	X
Counting	X	X	X	X	X		X				

Create a new library item

To create a new library item:

1. Long press the **Menu** button until you see **C.R.L.** Short press the **No** button several times to navigate until you see **L. i.b.** Press the **Yes** button.
2. Press the **Yes** button when you see **NEW**.
3. The display shows **TYPE**. Press the **Yes** button to select. Short press the **No** button to select from Weighing (**WGT IGH**), Percent (**PERCENT**), Dynamic (**dynamic**) and Filling (**FILL**). When you see the type you want, press the **Yes** button to select.
4. The display shows **PN**. Press the **Yes** button to input the PN number. Input by using the numeric keyboard. Press the **Yes** button when you finish.
5. The display shows **NAME**. Press the **Yes** button to input the name. Input by using the numeric keyboard. Press the **Yes** button when you finish.
6. Then the display shows other values as listed in the previous table for each mode. Press the **Yes** button to input each value. Input by using the numeric keyboard. Press the **Yes** button when you finish.
7. The display shows **END** when you finish all the settings. Press the **Yes** button to confirm.
8. The display shows **SAVE**. Press the **Yes** button to save.
9. The display shows the next menu **Ed it.** Press the **Exit** button to exit.

Note: If you do not need to input values for some items from step 5 to 7, you can press the **No** button to skip to the next item.

Edit a library item

To edit a library item:

1. Long press the **Menu** button until you see **CLRL**. Short press the **No** button several times to navigate until you see **Lib**. Press the **Yes** button.
2. Press the **No** button to select until you see **Edit**. Press the **Yes** button.
3. The display shows **SEARCH**. Press the **Yes** button.
4. Input the PN number for the library item you need to edit. Use the numeric keyboard to input and press the **Yes** button when you finish.

Search also supports inputting abbreviated PN. If you need to search the PN number, input at least one number of the PN of that item through the numeric keyboard and then press the **Yes** button. The first PN includes the number you input will be displayed. Short press the **No** button to navigate between different product numbers. When you see the one you want, press the **Yes** button to confirm.

If you input more than one number of the PN, make sure they are consequent.

For example, if you want to search a library item with PN 76543, to input only one number, you can input 7, 6, 5, 4 or 3. To input more than one number, you can input 76, 765, 54, 543 etc. Please avoid inputting inconsequent numbers, such as 74, 753 etc. The result will not appear.

5. The display shows the PN number of the library item to edit. Press the **Yes** button to confirm.
6. The display shows **TYPE**.
 - Press the **Yes** button if you need to edit it. Then short press the **No** button to select from Weighing (**WEIGH**), Percent (**PERCENT**), Dynamic (**ДYNAMIC**) and Filling (**FILL**). When you see the type you want, press the **Yes** button.
 - Press the **No** button if you do not need to edit it and move on to the next item.
7. Repeat step 6 to edit all the items you need to.
8. When you finish, continue to press the **No** button until you see **END**. Press the **Yes** button to confirm.
9. The display shows **SAVE**. Press the **Yes** button to save.
10. The display shows **END**. Press the Exit button to exit.

Recall a library item

To recall and use a library item when in Weighing, Counting, Percent, Dynamic and Fill mode:

Through input:

- Input the PN for the library item through the numeric keyboard in those weighing modes. Then long press the **Lib** button until you see the product number on the display. Press the **Yes** button to confirm.
- Search also supports inputting abbreviated PN. To do this, you can input at least one number of the PN through the numeric keyboard and then long press the **Lib** button. The first product number includes the number you input will be displayed. Short press the **No** button to navigate between different product numbers. When you see the one you want, press the **Yes** button to confirm.

If you input more than one number of the PN, make sure they are consequent.

For example, if you want to search a library item with PN 76543, you can input 76, 765, 54, 543 etc. Please avoid inputting inconsequent numbers, such as 74, 753 etc. The result will not appear.

Through RFID or Barcoder

When the product number input through an RFID or a Barcoder matches a product number in the library, the terminal will recall the library record.

When a library record is in use, an arrow on the screen will point to the library icon .

Disuse a library item

To disuse a library item when in Weighing, Counting, Percent, Dynamic or Fill mode:

1. When weighing in the modes above, long press the **Lib** button. The display shows the product number of the library item in use.
2. Press the **CLR** button when you see the product number displayed. The display shows **CLRL**. Press the **Yes** button to clear. Press the **No** button to return to the active application mode.

4.12 User (for i-DT61XWE model)

Enter this menu **U.S.E.r** to add or edit users. The maximum user number is 100. The record contains ID and name. The length of ID and name is about 32 characters.

Add a user

To add a new user:

1. Long press the **Menu** button until you see **C.R.L**. Short press the **No** button several times until you see **U.S.E.r**. Press the **Yes** button.
2. The display shows **NEW**. Press the **Yes** button.
3. The display shows **Id**. Press the **Yes** button, and then input the new id through the numeric keyboard. Press the **Yes** button when you finish.
4. The display shows **NAME**. Press the **Yes** button, and then input the new name through the numeric keyboard. Press the **Yes** button when you finish.
5. The display shows **END**. Press the **Yes** button.
6. The display shows **SAVE**. Press the **Yes** button to save, and the display moves to the next menu **Ed It**.

Edit a user

To edit a user:

1. Long press the **Menu** button until you see **C.R.L**. Short press the **No** button several times until you see **U.S.E.r**. Press the **Yes** button.
2. The display shows **NEW**. Short press the **No** button to select **Ed It**. Press the **Yes** button.
3. The display shows **SEARCH**. Press the **Yes** button.
4. Input the user id through the numeric keyboard. Press the **Yes** button. The display shows the id of the user. Press the **Yes** button.

Alternatively, search also supports inputting abbreviated ID. You can input at least one number of the id through the numeric keyboard and then press the **Yes** button. The first user id includes the number you input will be displayed. Short press the **No** button to navigate between different ids. When you see the one you want, press the **Yes** button to confirm.

If you input more than one number of the id, make sure they are consequent.

For example, if you want to search an id 76543, to input only one number, you can input 7, 6, 5, 4 or 3. To input more than one number, you can input 76, 765, 54, 543 etc. Please avoid inputting inconsequent numbers, such as 74, 753 etc. The result will not appear.

5. The display shows **Id**. Press the **Yes** button, and then input the new id through the numeric keyboard. Press the **Yes** button when you finish.
6. The display shows **NAME**. Press the **Yes** button, and then input the new name through the numeric keyboard. Press the **Yes** button when you finish.
7. The display shows **END**. Press the **Yes** button.
8. The display shows **SAVE**. Press the **Yes** button to save.
9. The display shows **END**. Press the **Yes** button and the display shows **END**. Press the **Yes** button to exit.

Recall a user

To recall a user when in Weighing, Counting, Percent, Dynamic or Fill mode:

Through input:

- Input the user ID through the numeric keyboard in those weighing modes. Then long press the **User** button until you see the ID on the display. Press the **Yes** button to confirm.
- Search also supports inputting abbreviated ID. To do this, you can input at least one number of the ID through the numeric keyboard and then long press the **User** button. The first product number includes the number you input will be displayed. Short press the **No** button to navigate between different IDs. When you see the one you want, press the **Yes** button to confirm.

If you input more than one number of the ID, make sure they are consequent.

For example, if you want to search a user ID 76543, you can input 76, 765, 54, 543 etc. Please avoid inputting inconsequent numbers, such as 74, 753 etc. The result will not appear.

Through RFID or Barcoder

When the user id input through an RFID or a Barcoder matches a user id in the library, the terminal will recall the user.

When a user is in use, an arrow on the screen will point to the user icon . Later when you select user in the printing template, the user's ID will be printed.

Disuse a user

To disuse a user when in Weighing, Percent, Dynamic or Fill mode:

1. When weighing in the modes above, long press the **User** button. The display shows the currently used user ID.
2. Press the **CLR** button when you see the ID displayed. The display shows **CLRL Ib**. Press the **Yes** button to clear. Press the **No** button to return to the active application mode.

4.13 USB (for i-DT61XWE model)

This menu will display when plug in a USB Flash Drive, RFID, Barcode Scanner, Keyboard or a Wi-Fi/Bluetooth Dongle (optional).

Menu	Sub-Menu	Sub-Menu(in segment)	Options	Options (in segment)
USB U.S.b	Reset	rESEt	No, Yes	NO, YES
	TYPE	tYPE	Flash Drive /RFID /Barcode Scanner /Keyboard	d ISr, rF Id, bArCod, tEybd
	export menu[Flash Drive]	E.MENU	\	
	import menu[Flash Drive]	I.MENU	\	
	export lib[Flash Drive]	E.L Ib	\	
	import lib[Flash Drive]	I.L Ib	\	
	export user[Flash Drive]	E.USER	\	
	import user[Flash Drive]	I.USER	\	
	Length[Barcode]	LENGtH	XXXXXXXX	
	Start digit[Barcode]	S.d IG It	XX	
End	End	\	/	

4.13.1 USB Flash Drive

The function of the USB Flash Drive menu is defined below:

E.MENU	Export Menu Settings to a USB flash drive
I.MENU	Import Menu Settings from a USB flash drive
E.L Ib	Export Libraries to a USB flash drive
I.L Ib	Import Libraries from a USB flash drive
E.USER	Export User Profiles to a USB flash drive
I.USER	Import User Profiles from a USB flash drive

Note: The Menu Settings /User /Library can be exported to a flash drive. This flash drive can be inserted into another terminal, and the Menu Settings can be imported to the terminal. After the import is finished, the terminal will restart. After that the menu configurations of the two terminals are the same.

4.13.2 RFID

Use an RFID reader to search PN (product number) / user ID to recall and use the related library item or user during weighing.

Use an RFID reader to input numbers when in the input mode.

Since there are many brands of RFID device in the market, OHAUS tested and confirmed that below one from RFIDEas (www.RFIDEas.com) is compatible:

RDR-6081AKU-C06.

4.13.3 Barcode

Use a barcode scanner to search PN (product number) / user ID to recall and use the related library item or user during weighing.

Use a barcode scanner to input numbers when in the input mode.

LENGTH	Specify the length of the string read from the barcode scanner.
START DIGIT	Specify the start digit of the string read from the barcode scanner. The barcode scanner will only response when the start digit matches your setting.

Since there are many brands of barcode scanners in the market, OHAUS tested and confirmed that below Barcode scanners from Datalogic® is compatible:
QuickScan series

4.13.4 Keyboard

Use a keyboard to input numbers when in the input mode.

4.13.5 Wi-Fi/Bluetooth Dongle (Optional)

A Wi-Fi/Bluetooth USB Dongle can help the terminal to receive data transmitted through Wi-Fi or Bluetooth. It is an option and you can contact an authorized OHAUS dealer to get it.

4.13.5.1 Install a Wi-Fi/Bluetooth USB Dongle

- 1 Remove the M25 cover located at the bottom of the indicator.

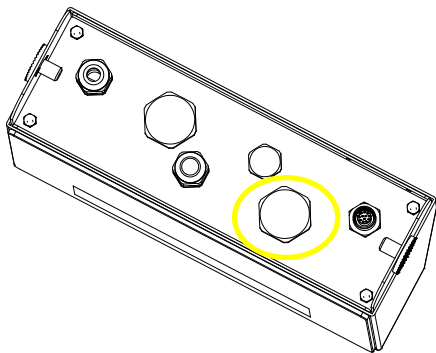

- 2 Plug the Wi-Fi/Bluetooth USB Dongle through M25 hole.

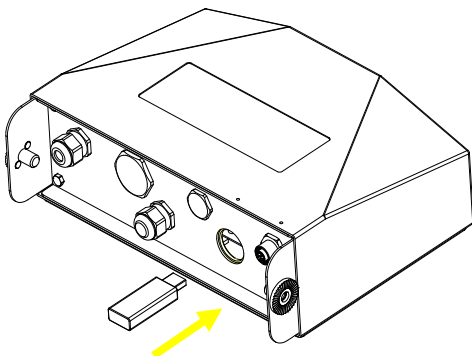

- 3 Close the USB Dongle Cover.

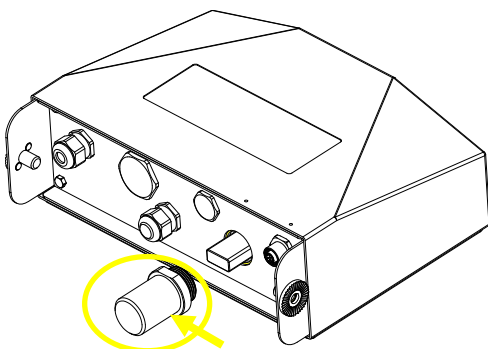

Note: This cover is also an option, please contact an authorized OHAUS dealer to get it.

4.13.5.2 Configuration

After inserting the dongle, the indicator will recognize it and add relevant items to the menu. The indicator will display the IP address, and you need to set other parameters through the OHAUS ScaleMate software. To get the software, please contact an OHAUS authorized dealer.

Note: for how to set parameters in the ScaleMate software, please check the software's instruction video via an authorized OHAUS dealer.

Wireless setup

Menu	Sub-Menu	Sub-Menu (in segment)	Options	Options (in segment)
Wireless Wi-Fi-Bluetooth	Reset	RESET	No, Yes	NO, YES
	Type	TYPE	wifi, bluetooth	WiFi, Bluetooth
	IP Address[Wifi]	IP Addr	XXXXXX-XXXX (169.254.1.1-6060)	/
	Device name[bt]	Device Name	XXXXXX	/
	Pincode[bt]	Pin	XXXXXX	/
	Alt Print CMD	Alt.P	A~Z, P	/
	Alt Tare CMD	Alt.T	A~Z, T	/
	Alt Zero CMD	Alt.Z	A~Z, Z	/
	End	END	\	/

MAC Address

The Medium Access Control (MAC) Address of the Wi-Fi/Bluetooth is not editable.

Port

The default value of IP port is 6060.

DHCP

If DHCP is set to be **ON**, the IP share or router will automatically assign IP Address. If the DHCP is set to be **OFF**, users need to setup the IP Address, Subnet Mask, Gateway, Primary DNS and Secondary DNS. If there is no DHCP server in the network, the DHCP server of the Ethernet option board will become it.

Note: After the setup of IP Address, Subnet Mask, Gateway, Primary DNS and Secondary DNS, please reboot the indicator to enable the setting.

IP Address

IP is 192.168.1.2 by default.

Subnet Mask

Subnet mask is 255.255.255.0 by default.

Gateway

Gateway is 192.168.1.1 by default.

Primary DNS & Secondary DNS

DNS value is not needed when the system connects to a LAN, and it is assigned by the ISP when connected to the internet.

Alternative Command

The alternative command of Print, Tare, Zero can be set to 'a' ~ 'z' or 'A' ~ 'Z'.

Note: The submenu will display after the installation of the dongle.

Print Setup

For Wi-Fi and Bluetooth printing setup, please refer to the **Print Menu** section in the **Communication** part for details about printing settings.

Bluetooth setup

To pair your device with the terminal through Bluetooth, take Windows 10 as an example:

1. Click **Settings** in the **Start** menu.
2. Select **Devices (Bluetooth, printers, mouse)** in the pop out **Settings** window or type Bluetooth in the search bar of the window to launch **Bluetooth & other devices** program.
3. Click **Add Bluetooth or other device**.
4. Select **Bluetooth** in the pop up **Add a device** window.
5. Select the Bluetooth name of your terminal to pair, and then check the pin code appeared with it.
6. Input the pin code through the numeric keyboard on your terminal.
7. If **Your device is ready to go** appears on your computer, it implies the connection is successful.
8. If you need to check which COM (serial) ports your computer's Bluetooth is using, please follow the following steps:
 - a) On the **Bluetooth & other devices** page, instead of clicking **Add Bluetooth or other device**, turn down the page and find **More Bluetooth options** under **Related settings**.
 - b) Click **More Bluetooth options**.
 - c) Select **COM Ports** on the top bar, and you will see the using COM (serial) ports displayed.

Note: if you use other device to pair with the terminal, please follow the specific device's Bluetooth pairing method.

5. LEGAL FOR TRADE

When the indicator is used in trade or a legally controlled application, it must be set up, verified and sealed in accordance with local weights and measures regulations. It is the responsibility of the purchaser to ensure that all pertinent legal requirements are met.

5.1 Settings

Before verification and sealing, perform the following steps:

1. Verify that the menu settings meet the local weights and measures regulations.
2. Perform a calibration as explained in **Calibration Menu** section.
3. Turn the indicator off.

To turn on the security switch:

1. Disconnect power from the indicator and open the housing as explained in **Opening the Housing** section in the **Installation** chapter. (Remove the batteries for i-DT61PW model).
2. Set the position of the security switch SW1 to ON. (Check **Mainboard** section for where SW1 is located on the mainboard).
3. Close the housing.
4. Reconnect power and turn the indicator on. (Re-install the batteries for i-DT61PW model).

5.2 Verification

The local weights and measures official or authorized service agent must perform the verification procedure.

5.3 Sealing

After the scale has been verified, it must be sealed to prevent undetected access to the legally controlled settings. The sealing is different depends on the base connection method. Refer to the instructions below for an appropriate sealing method.

5.3.1 Sealing for Base without EasyConnect

If the terminal connects to a base without EasyConnect (refer 2.3.2 Scale Base without EasyConnect™ Connector), the scale can be sealed using Wire Sealing (figure 5-1 and 5-3) or Paper Sealing (figure 5-2 and 5-4).

5.3.2 Sealing for EasyConnect Base with Memory Module

When the i-DT61PW or i-DT61XWE indicator is connected to an OHAUS Defender 6000 series base boasting EasyConnect™ function and has a memory module (refer Figure 5-5) on the load cell cable, seal the scale using Wire Sealing (figure 5-1 and 5-3) or Paper Sealing (figure 5-2 and 5-4).

The connection cable does not need hardware sealing because it is sealed by software pairing. Once the indicator or the base is replaced by a new one, an error message (**Error 8.9**) will pop up in the indicator's displayed window.

Notice: If it uses an external connection such as EasyConnect to connect a base **without memory module**, the completed scale **CANNOT** be used in Legal For Trade because the connection between the indicator and the base cannot be sealed in physical and software methods.

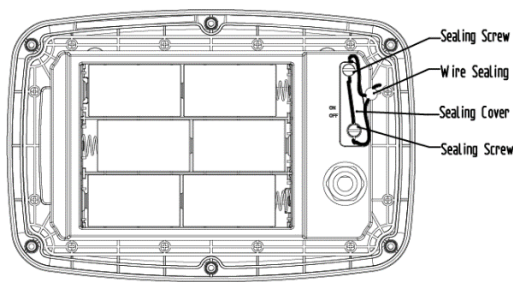

Figure 5-1. i-DT61PW Wire Sealing

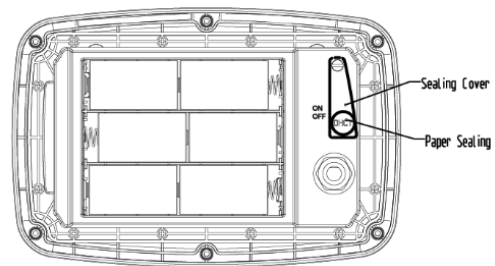

Figure 5-2. i-DT61PW paper Sealing

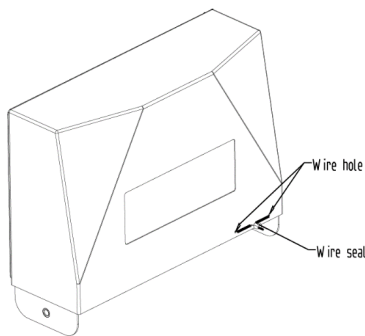

Figure 5-3. i-DT61PW Wire Sealing

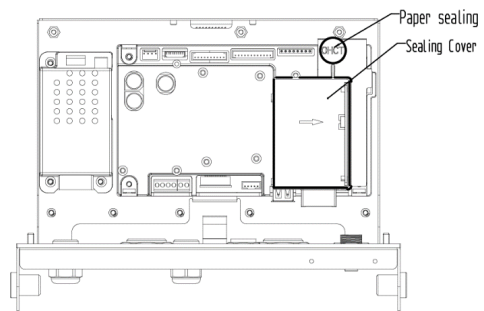

Figure 5-4. i-DT61XWE Paper Sealing

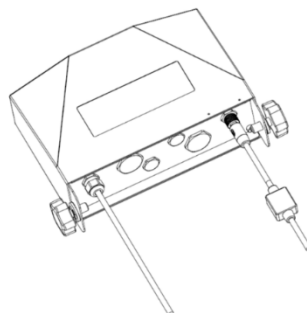

Figure 5-5. Connecting cable with connector and memory module

6. MAINTENANCE

CAUTION: DISCONNECT THE UNIT FROM THE POWER SUPPLY BEFORE CLEANING.

6.1 Cleaning



WARNING: Electric Shock Hazard. Disconnect the equipment from the power supply before cleaning. Make sure that no liquid enters the interior of the instrument.



Attention: Do not use solvents, harsh chemicals, ammonia or abrasive cleaning agents.

The housing may be cleaned with a cloth dampened with a mild detergent if necessary.

6.1.1 Cleaning for i-DT61PW Model

- The housing may be cleaned with a cloth dampened with a mild detergent if necessary.
- Do not use solvents, chemicals, alcohol, ammonia or abrasives to clean the housing or the control panel.

6.1.2 Cleaning for i-DT61XWE Model

- Use approved cleaning solutions for the stainless-steel Indicator housing and rinse with water. Dry thoroughly.
- Do not use solvents, chemicals, alcohol, ammonia or abrasives to clean the control panel.

6.2 Troubleshooting

TABLE 6-1 Troubleshooting

SYMPTOM	PROBABLE CAUSE (s)	REMEDY
EEP Error	EEPROM Checksum Error	Corrupted EEPROM data
Unit will not turn on.	<ol style="list-style-type: none"> 1. Power cord not plugged in or properly connected. 2. Power outlet not supplying electricity. 3. Battery discharged (i-DT61PW). 4. Other failure. 	<ol style="list-style-type: none"> 1. Check power cord connections. Make sure power cord is plugged in properly into the power outlet. 2. Check power source. 3. Replace batteries (i-DT61PW). 4. Service required.
Cannot zero the Scale, or will not zero when turned on.	<ol style="list-style-type: none"> 1. Load on Scale exceeds allowable limits. 2. Load on Scale is not stable. 3. Load Cell damage. 	<ol style="list-style-type: none"> 1. Remove load on Scale. 2. Wait for load to become stable. 3. Service required.
Unable to calibrate.	<ol style="list-style-type: none"> 1. Lock Calibration Menu set to On. 2. LFT menu set to On. 3. Incorrect value for calibration mass. 	<ol style="list-style-type: none"> 1. Set Lock Calibration Menu to Off. 2. Refer to Section 3.12 Menu Lock. 3. Set LFT menu to Off. 4. Use correct calibration mass.
Cannot display weight in desired weighing unit.	Unit not set to On.	Enable unit in the Units Menu. Refer to Unit Menu section for help.
Cannot change menu settings.	Menu has been locked.	<ol style="list-style-type: none"> 1. Set selected menu to Off in the Lock Menu. 2. Lockout Switch on the circuit board may need to be set to the Off position.
<i>Error 8.1</i>	Weight reading exceeds Power On Zero limit.	<ol style="list-style-type: none"> 1. Remove load from scale. 2. Recalibrate scale.
<i>Error 8.2</i>	Weight reading below Power On Zero limit.	<ol style="list-style-type: none"> 1. Add load to scale. 2. Recalibrate scale.
<i>Error 8.3</i>	Weight reading exceeds Overload limit.	Reduce load on scale.
<i>Error 8.4</i>	Weight reading below Underload limit.	<ol style="list-style-type: none"> 1. Add load to scale. 2. Recalibrate scale.
<i>Error 8.5</i>	Weight exceeds six digits. Display overflow.	Reduce load on scale.
<i>Error 8.8</i>	Factory calibration data in memory module at the end of the load cell cable is not valid under LFT OFF	Calibrate scale.

	status.	
Error 8.9	Fail to read serial number from memory module or serial number does not match the indicator's under LFT ON status.	Break the seal or replace the original base/indicator.
Error 8.90	The serial number of EasyConnect™ base does not match the serial number stored inside indicator under LFT ON status.	Switch back the original EasyConnect™ base.
Error 8.91	Fail to read data from the EasyConnect™ module under LFT ON status.	<ol style="list-style-type: none"> 1. Check if the cable connection is ok. 2. Break the seal, perform factory reset and recalibrate the scale.
Error 8.92 Error 8.94	Incorrect data from EasyConnect™ base under LFT ON status.	<ol style="list-style-type: none"> 1. Break the seal or replace the original base/indicator. 2. Service required.
Error 8.93	The EasyConnect™ base is connected to a blank indicator under the LFT ON status.	Break the seal, connect base to the indicator and power on the scale. Power off the scale and perform sealing again.
Error 9.5	Calibration data not present.	Calibrate scale.
Battery symbol flashing	Batteries are discharged.	Replace batteries (i-DT61PW).
ERR E	Calibration value outside allowable limits	Use correct calibration weight.
NO.566	Attempting to exit the menu with the LFT setting ON and the security switch OFF.	Refer to LEGAL FOR TRADE chapter for details about how to set the security switch to the ON position.
REF Wt Err	Reference Weight too small. The weight on the platform is too small to define a valid reference weight.	Use a heavier weight for sample.

6.3 Service Information

If the troubleshooting section does not resolve your problem, contact an authorized OHAUS Service Agent. For Service assistance in the United States, call toll-free 1-800-526-0659 between 8:00 AM and 5:00 PM Eastern Standard Time. An OHAUS Product Service Specialist will be available to assist you. Outside the USA, please visit our website www.ohaus.com to locate the OHAUS office nearest you.

7. TECHNICAL DATA

7.1 Specifications

Materials

I-DT61XWE Housing: stainless-steel 316

I-DT61PW Housing: polycarbonate (PC)

Display window: polycarbonate (PC)

Keypad: polycarbonate (PC)

Equipment Ratings:

Indoor use only

Altitude: 2,000m

Operating temperature: -10°C to 40°C

Humidity: maximum relative humidity 80% for temperatures up to 31 °C decreasing linearly to 50% relative humidity at 40°C.

Electrical supply: 100 - 240V~, 0.5A, 50/60Hz (i-DT61XWE); 6 x D alkaline battery (i-DT61PW).

Voltage fluctuations: Mains supply voltage fluctuations up to ±10% of the nominal voltage.

Overvoltage category (Installation category): II

Pollution degree: 2

Model	i-DT61PW
Construction	Polycarbonate plastic housing, 304 stainless steel bracket
Protection	IP68/IP69k
Maximum displayed resolution	1:75,000
Maximum approved resolution	1:10,000 (EC, OIML & NTEP) Class III
Weighing Units	Kilogram, Gram, Pound, Ounce, Pound: Ounce, Tonne (Metric Tonne)
Modes	Basic weighing, Percent weighing, Piece Counting with Optimized APW, Check weighing/counting, Dynamic weighing
Display	6-digit, 7-segment LCD display with white backlight, 45 mm high digits
Check Indicator	3 color (red, green, yellow) bar LED
Keyboard	6 function mechanical keys
Auto-zero Tracking	Off, 0.5 d, 1 d or 3 d
Load cell excitation voltage	3.3VDC
Load cell drive	Up to 4 x 350 ohm load cells
Load cell input sensitivity	Up to 3 mV/V
Power	6 x D alkaline battery
Battery Life	1,500 hours continuous use with backlight off
Interface	Infrared USB communication port
Shipping Dimensions	300 x 265 x 135 mm 11.8 x 10.4 x 5.3 in
Product Dimensions (with bracket)	10.4 x 8.9 x 3.3 in / 265 x 225 x 85 mm
Approx. Net Weight	2.7 kg / 6.0 lb
Approx. Shipping Weight	3.8 kg / 8.4 lb
Operating Temperature Range	14°F to 104°F / -10°C to 40°C

Model	i-DT61XWE
Construction	316 Stainless steel housing, 316 stainless steel bracket
Protection	IP68/IP69k
Maximum displayed resolution	1:75,000
Maximum approved resolution	1:10,000 (EC, OIML & NTEP) Class III
Weighing Units	Kilogram, Gram, Pound, Ounce, Pound: Ounce
Modes	Basic weighing, Percent weighing, Check weighing/percent, Dynamic weighing, Filling weighing, Counting
Display	6-digit, 7-segment white LED, 20 mm high digits
Check Indicator	3 color (red, green, orange) 8x16 dot matrix LED
Keyboard	6 function keys + 12 alpha numeric capacitive keypad
Auto-zero Tracking	Off, 0.5 d, 1 d or 3 d
Load cell excitation voltage	5VDC
Load cell drive	Up to 4 x 350 ohm load cells
Load cell input sensitivity	Up to 3 mV/V
Stabilization time	Within 2 seconds
Power	100-240 VAC / 50/60 Hz Universal Power Supply, hardwired
Interface	Standard: RS232, USB Host Optional: Ethernet, Wi-Fi/Bluetooth, 2nd RS232/RS485/USB, Analog output, 2 In/4 Out Discrete I/O
Shipping Dimensions	300 x 265 x 135 mm 11.8 x 10.4 x 5.3 in
Product Dimensions (with bracket)	11.4 x 9.3 x 3.1 in / 290 x 235 x 80 mm
Approx. Net Weight	3.2 kg / 7.0 lb
Approx. Shipping Weight	3.5 kg / 7.7 lb
Operating Temperature Range	14°F to 104°F / -10°C to 40°C

7.2 Accessories and Options

TABLE 7-2 OPTIONS

P/N	Description
30412537	Wi-Fi/Bluetooth Dongle i-DT61XW
30424403	Analog Output kit i-DT61XW
30424404	2nd RS232/RS485/USB Device kit i-DT61XW
30424021	Light Tower, 3 Colors, 243mm, IP65 (Requires 30097591)
30424409	LC Extension Cable, 9 meters
30803566	LC Extension Cable, 3.5 meters
30379716	M16 Gland with Ferrite
30097591	Discrete I/O with Relay (2 In/4 Out) i-DT61XW
30429666	Ethernet kit i-DT61XW
30572907	External Power Bank Holder i-DT61XW (Requires external USB power bank)
80500552	Cable RS232 i-DT61XW
80500503	Alibi Memory i-DT61XW
30572910	IR communication kit i-DT61PW



The RS232 Kit, RS422/485 Kit, Discrete I/O Kit and Analog Output Kit must be installed by a qualified technician.

Defender 6000 XW

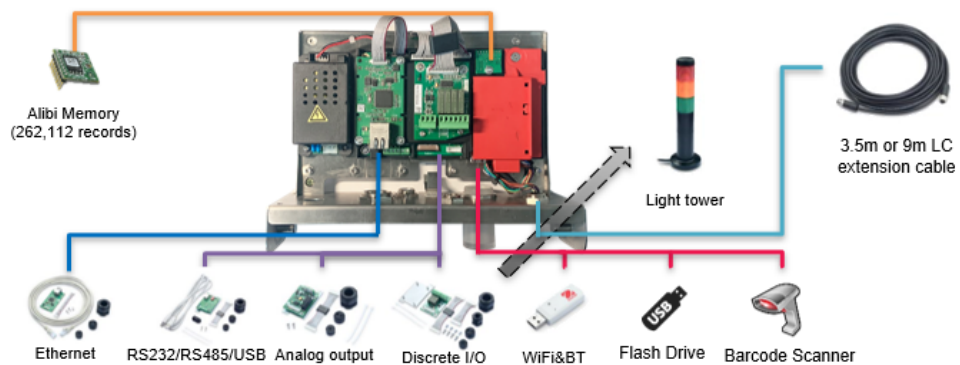

Defender 6000 PW



IR communication kit





7.3 Table of Geo Values

TABLE 7-1 GEO CODES

		Elevation in meters										
		0	325	650	975	1300	1625	1950	2275	2600	2925	3250
		325	650	975	1300	1625	1950	2275	2600	2925	3250	3575
		Elevation in feet										
		0	1060	2130	3200	4260	5330	6400	7460	8530	9600	10660
		1060	2130	3200	4260	5330	6400	7460	8530	9600	10660	11730
Latitude		GEO value										
0°00'	5°46'	5	4	4	3	3	2	2	1	1	0	0
5°46'	9°52'	5	5	4	4	3	3	2	2	1	1	0
9°52'	12°44'	6	5	5	4	4	3	3	2	2	1	1
12°44'	15°06'	6	6	5	5	4	4	3	3	2	2	1
15°06'	17°10'	7	6	6	5	5	4	4	3	3	2	2
17°10'	19°02'	7	7	6	6	5	5	4	4	3	3	2
19°02'	20°45'	8	7	7	6	6	5	5	4	4	3	3
20°45'	22°22'	8	8	7	7	6	6	5	5	4	4	3
22°22'	23°54'	9	8	8	7	7	6	6	5	5	4	4
23°54'	25°21'	9	9	8	8	7	7	6	6	5	5	4
25°21'	26°45'	10	9	9	8	8	7	7	6	6	5	5
26°45'	28°06'	10	10	9	9	8	8	7	7	6	6	5
28°06'	29°25'	11	10	10	9	9	8	8	7	7	6	6
29°25'	30°41'	11	11	10	10	9	9	8	8	7	7	6
30°41'	31°56'	12	11	11	10	10	9	9	8	8	7	7
31°56'	33°09'	12	12	11	11	10	10	9	9	8	8	7
33°09'	34°21'	13	12	12	11	11	10	10	9	9	8	8
34°21'	35°31'	13	13	12	12	11	11	10	10	9	9	8
35°31'	36°41'	14	13	13	12	12	11	11	10	10	9	9
36°41'	37°50'	14	14	13	13	12	12	11	11	10	10	9
37°50'	38°58'	15	14	14	13	13	12	12	11	11	10	10
38°58'	40°05'	15	15	14	14	13	13	12	12	11	11	10
40°05'	41°12'	16	15	15	14	14	13	13	12	12	11	11
41°12'	42°19'	16	16	15	15	14	14	13	13	12	12	11
42°19'	43°26'	17	16	16	15	15	14	14	13	13	12	12
43°26'	44°32'	17	17	16	16	15	15	14	14	13	13	12
44°32'	45°38'	18	17	17	16	16	15	15	14	14	13	13
45°38'	46°45'	18	18	17	17	16	16	15	15	14	14	13
46°45'	47°51'	19	18	18	17	17	16	16	15	15	14	14
47°51'	48°58'	19	19	18	18	17	17	16	16	15	15	14
48°58'	50°06'	20	19	19	18	18	17	17	16	16	15	15
50°06'	51°13'	20	20	19	19	18	18	17	17	16	16	15
51°13'	52°22'	21	20	20	19	19	18	18	17	17	16	16
52°22'	53°31'	21	21	20	20	19	19	18	18	17	17	16
53°31'	54°41'	22	21	21	20	20	19	19	18	18	17	17
54°41'	55°52'	22	22	21	21	20	20	19	19	18	18	17
55°52'	57°04'	23	22	22	21	21	20	20	19	19	18	18
57°04'	58°17'	23	23	22	22	21	21	20	20	19	19	18
58°17'	59°32'	24	23	23	22	22	21	21	20	20	19	19
59°32'	60°49'	24	24	23	23	22	22	21	21	20	20	19
60°49'	62°90'	25	24	24	23	23	22	22	21	21	20	20
62°90'	63°30'	25	25	24	24	23	23	22	22	21	21	20
63°30'	64°55'	26	25	25	24	24	23	23	22	22	21	21
64°55'	66°24'	26	26	25	25	24	24	23	23	22	22	21
66°24'	67°57'	27	26	26	25	25	24	24	23	23	22	22
67°57'	69°35'	27	27	26	26	25	25	24	24	23	23	22
69°35'	71°21'	28	27	27	26	26	25	25	24	24	23	23
71°21'	73°16'	28	28	27	27	26	26	25	25	24	24	23
73°16'	75°24'	29	28	28	27	27	26	26	25	25	24	24
75°24'	77°52'	29	29	28	28	27	27	26	26	25	25	24
77°52'	80°56'	30	29	29	28	28	27	27	26	26	25	25
80°56'	85°45'	30	30	29	29	28	28	27	27	26	26	25
85°45'	90°00'	31	30	30	29	29	28	28	27	27	26	26

8. COMPLIANCE

Compliance to the following standards is indicated by the corresponding mark on the product.

Mark	Standard
	This product complies with the applicable harmonized standards of EU Directives 2011/65/EU (RoHS), 2014/30/EU (EMC), 2014/35/EU (LVD) and 2014/31/EU (NAWI). The EU Declaration of Conformity is available online at www.ohaus.com/ce .
	This product complies with the EU Directive 2012/19/EU (WEEE) and 2006/66/EC (Batteries). Please dispose of this product in accordance with local regulations at the collecting point specified for electrical and electronic equipment. For disposal instructions in Europe, refer to www.ohaus.com/weee .
	EN 61326-1
	UL Std. No. 61010-1 CAN/CSA-C22.2 No. 61010-1

ISED Canada Compliance Statement:

This Class A digital apparatus complies with Canadian ICES-003.

ISO 9001 Registration

The management system governing the production of this product is ISO 9001 certified.

FCC Supplier Declaration of Conformity

Unintentional Radiator per 47CFR Part B
Trade Name: OHAUS CORPORATION
Model or Family identification: Defender6000

Issuing Party that Assembled the Product:

Ohaus Instruments (Changzhou) Co., Ltd.
Building C, No. 6 Zhengqiang Road, Xuejia Town, Xinbei District, Changzhou
Jiangsu 213022
China
Phone: +86 519 85287270

Responsible Party – U.S. Contact Information:

Ohaus Corporation
8 Campus Drive, Suite 105
Parsippany, NJ 07054
United States
Phone: +1 973 377 9000
Web: www.ohaus.com

FCC Compliance Statement:

Note: This equipment has been tested and found to comply with the limits for a Class A digital device, pursuant to part 15 of the FCC Rules. These limits are designed to provide reasonable protection against harmful interference when the equipment is operated in a commercial environment. This equipment generates, uses, and can radiate radio frequency energy and, if not installed and used in accordance with the instruction manual, may cause harmful interference to radio communications. Operation of this equipment in a residential area is likely to cause harmful interference in which case the user will be required to correct the interference at his own expense. Changes or modifications not expressly approved by the party responsible for compliance could void the user's authority to operate the equipment.

9. APPENDICES

9.1 Appendix A

MT Standard Continuous Output

A checksum character can be enabled or disabled with continuous output. The data consists of 17 or 18 bytes as shown in the standard continuous output.

Table 9-1.

Non-significant weight data and tare data digits are transmitted as spaces. The continuous output mode provides compatibility with OHAUS products that require real-time weight data. the standard continuous output. Table 9-1 shows the format for the standard continuous output.

Table 9-9.1-1: Standard Continuous Output Format

	Status ²			Indicated Weight ³						Tare Weight ⁴								
Character	1	2	3	4	5	6	7	8	9	10	11	12	13	14	15	16	17	18
Data	STX ¹	SB-A	SB-B	SB-C	MSD	-	-	-	-	LSD	MSD	-	-	-	-	LSD	CR ⁵	CHK ⁶

Continuous Output Format Notes:

1. ASCII Start of Text character (02 hex), always transmitted.
2. Status bytes A, B and C. Refer to Table 5-2, Table 5-3, and Table 5-4 for details of the structure.
3. Displayed weight. Either gross or net weight. Six digits, no decimal point or sign. Insignificant leading zeroes are replaced with spaces.
4. Tare weight. Six digits of tare weight data. No decimal point in field.
5. ASCII Carriage Return <CR> character (0D hex).
6. Checksum, transmitted only if enabled in setup. Checksum is used to detect errors in the transmission of data. Checksum is defined as the 2's complement of the seven low order bits of the binary sum of all characters preceding the checksum character, including the <STX> and <CR> characters.

Table 9-2, Table 9-3, and Table 9-4 detail the status bytes for standard continuous output.

Table 9-9.1-2: Status Byte A Bit Definitions

Bits 2, 1, and 0			
2	1	0	Decimal Point Location
0	0	0	XXXXXX00
0	0	1	XXXXXX0
0	1	0	XXXXXX
0	1	1	XXXXX.X
1	0	0	XXXX.XX
1	0	1	XXX.XXX
1	1	0	XX.XXXX
1	1	1	X.XXXXX
Bits 4 and 3			
4	3	Build Code	
0	1	X1	
1	0	X2	
1	1	X5	
Bit 5			Always = 1
Bit 6			Always = 0

Table 9-9.1-3: Status Byte B Bit Definitions

Status Bits	Function
Bit 0	Gross = 0, Net = 1
Bit 1	Sign, Positive = 0, Negative = 1
Bit 2	Out of Range = 1 (Over capacity or Under Zero)
Bit 3	Motion = 1, Stable = 0
Bit 4	lb = 0, kg = 1 (see also Status Byte C, bits 0, 1, 2)
Bit 5	Always = 1
Bit 6	Zero Not Captured after power-up = 1

Table 9-9.1-4: Status Byte C Bit Definitions

Bits 2, 1, and 0			Weight Description
2	1	0	
0	0	0	lb or kg, selected by Status Byte B, bit 4
0	0	1	grams (g)
0	1	0	metric tons (t)
0	1	1	ounces (oz)
1	0	0	not used
1	0	1	not used
1	1	1	tons (ton)
1	1	1	no units
Bit 3			Print Request = 1
Bit 4			Expand Data x 10 = 1, Normal = 0
Bit 5			Always = 1
Bit 6			Always = 0

9.2 Appendix B

MT-SICS Commands

	Command	Function
LEVEL 0	I0	Inquiry of all available SICS commands
	I1	Inquiry of SICS level and SICS versions
	I2	Inquiry of scale data
	I3	Inquiry of scale software version
	I4	Inquiry of serial number
	S	Send stable weight value
	SI	Send weight value immediately
	SIR	Send weight value repeatedly
	Z	Zero the scale
	ZI	Zero immediately
LEVEL 1	D	Write text into display
	DW	Weight display
	SR	Send and repeat stable weight value
	T	Tare
	TA	Tare value
	TAC	Clear tare
	TI	Tare immediately

	Command	Function
LEVEL 2	C2	Calibrate with the external calibration weight
	I10	Inquire or set scale ID
	I11	Inquire of scale type
	P101	Print out stable weight value
	P102	Print out current weight value immediately
	SIRU	Send weight value in the current unit immediately and repeat
	SIU	Send weight value in the current unit immediately
	SNR	Send stable weight value and repeat after every weight change
	SNRU	Send stable weight value in the current unit and repeat after every weight change
	SRU	Send weight value in the current unit and repeat
	SU	Send stable weight value in the current unit
	LEVEL 3	M01
M02		Stability setting
M03		Autozero function
M19		Send calibration weight
M21		Inquire/set weight unit
RST		Restart
SFIR		Send weight value immediately and repeat quickly
SIH		Send weight value immediately in high resolution
SWU		Switch weight unit
SX		Send stable data record
SXI		Send data record immediately
SXIR		Send data record immediately and repeat
U		Switch weight unit