

CUTSHEET

Front View

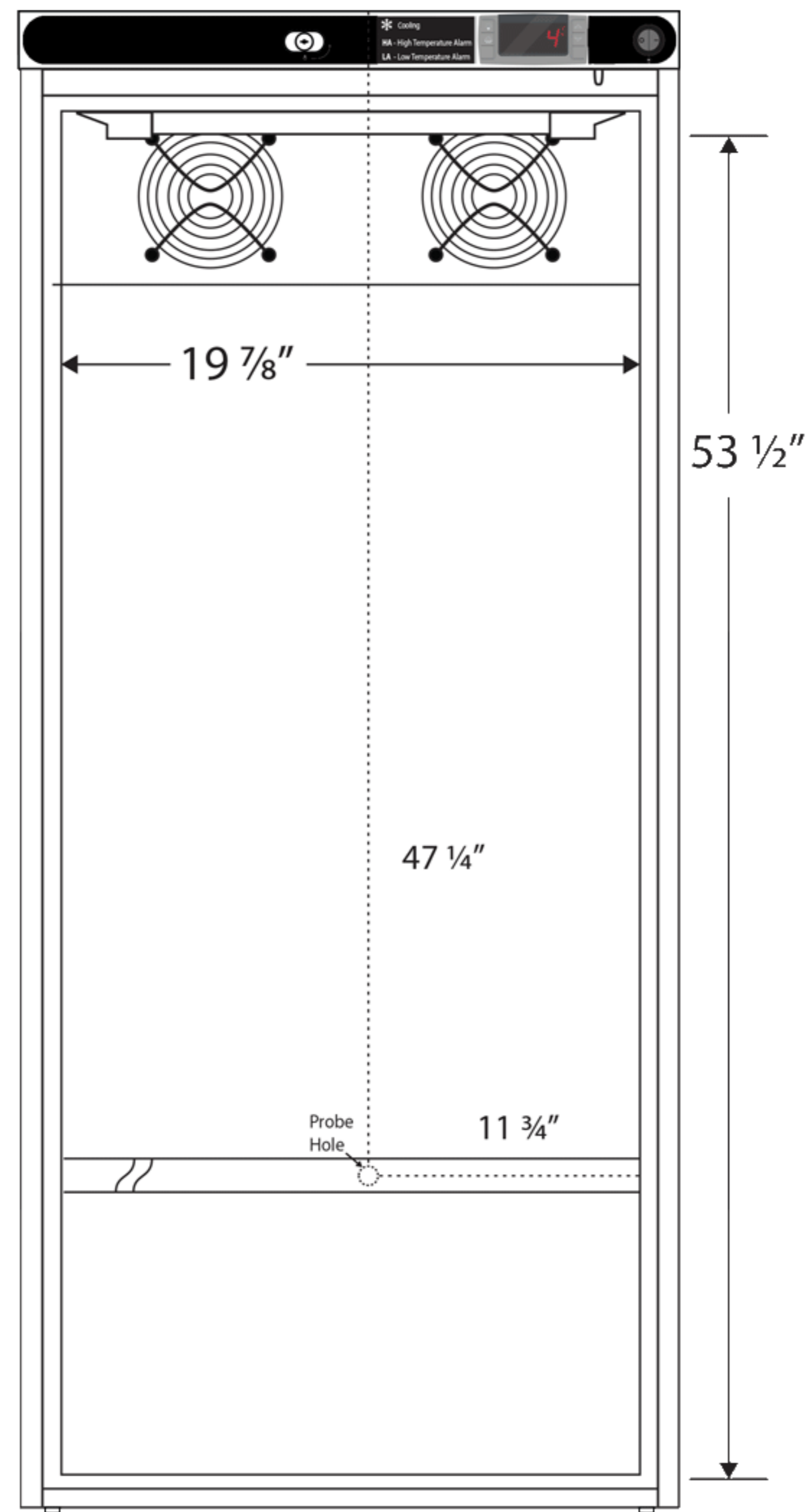

Side View

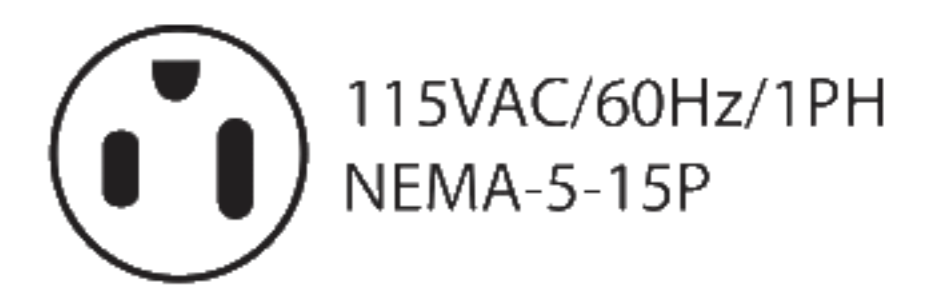
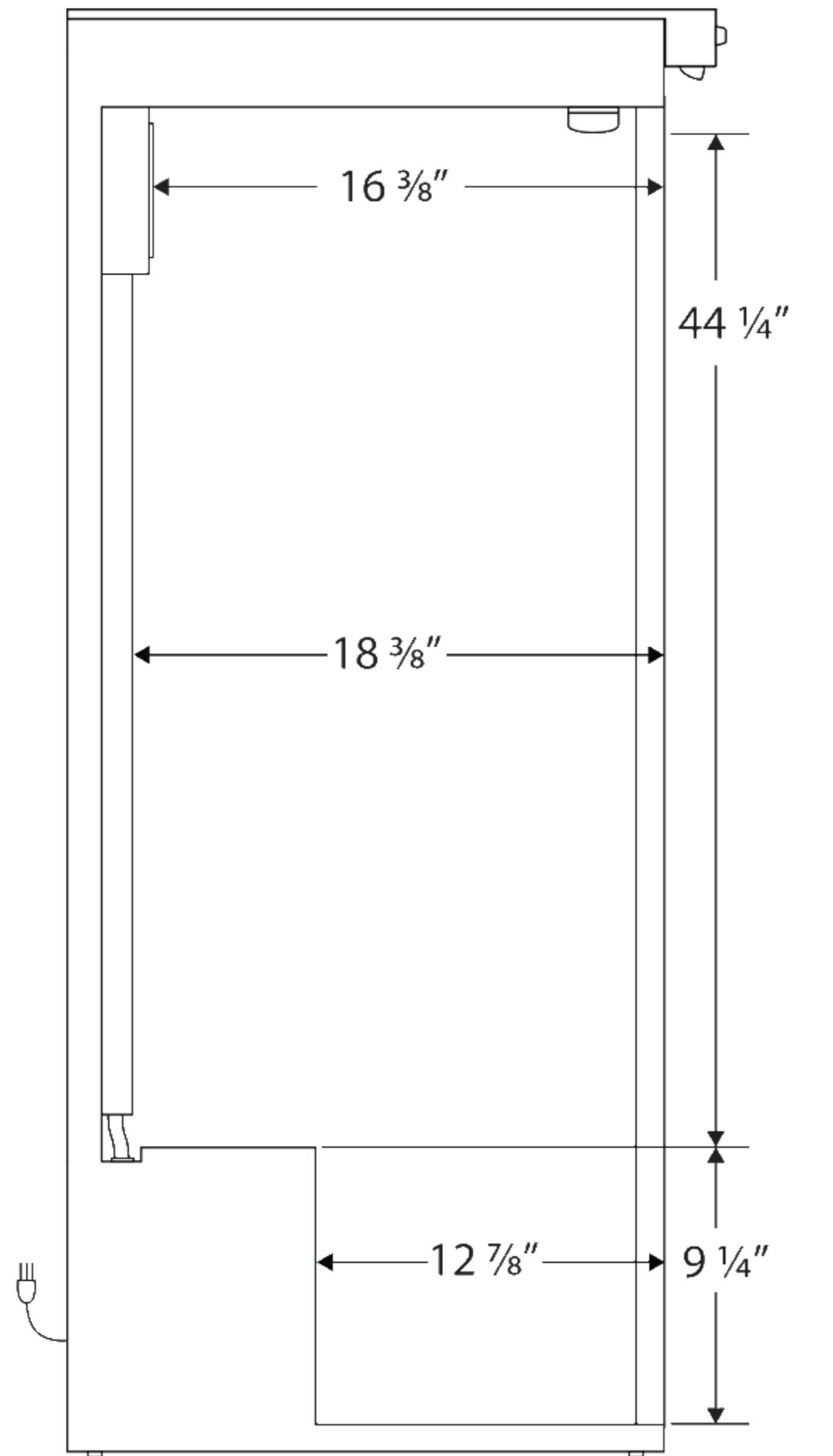

Cu. Ft	Defrost	Door	Int Door	Shelves	Interior Dim.			Refrigerant	H.P.	Amps	Weight
					W"	D"	H"				
10.5	Cycle	1 Solid	0	6 Adj +Footed Bottom	19 7/8	18 3/8	53 1/2	R600a	1/3	2.3	145 lbs.

Note: Interior dimensions are estimates and subject to change without notice