

Front View

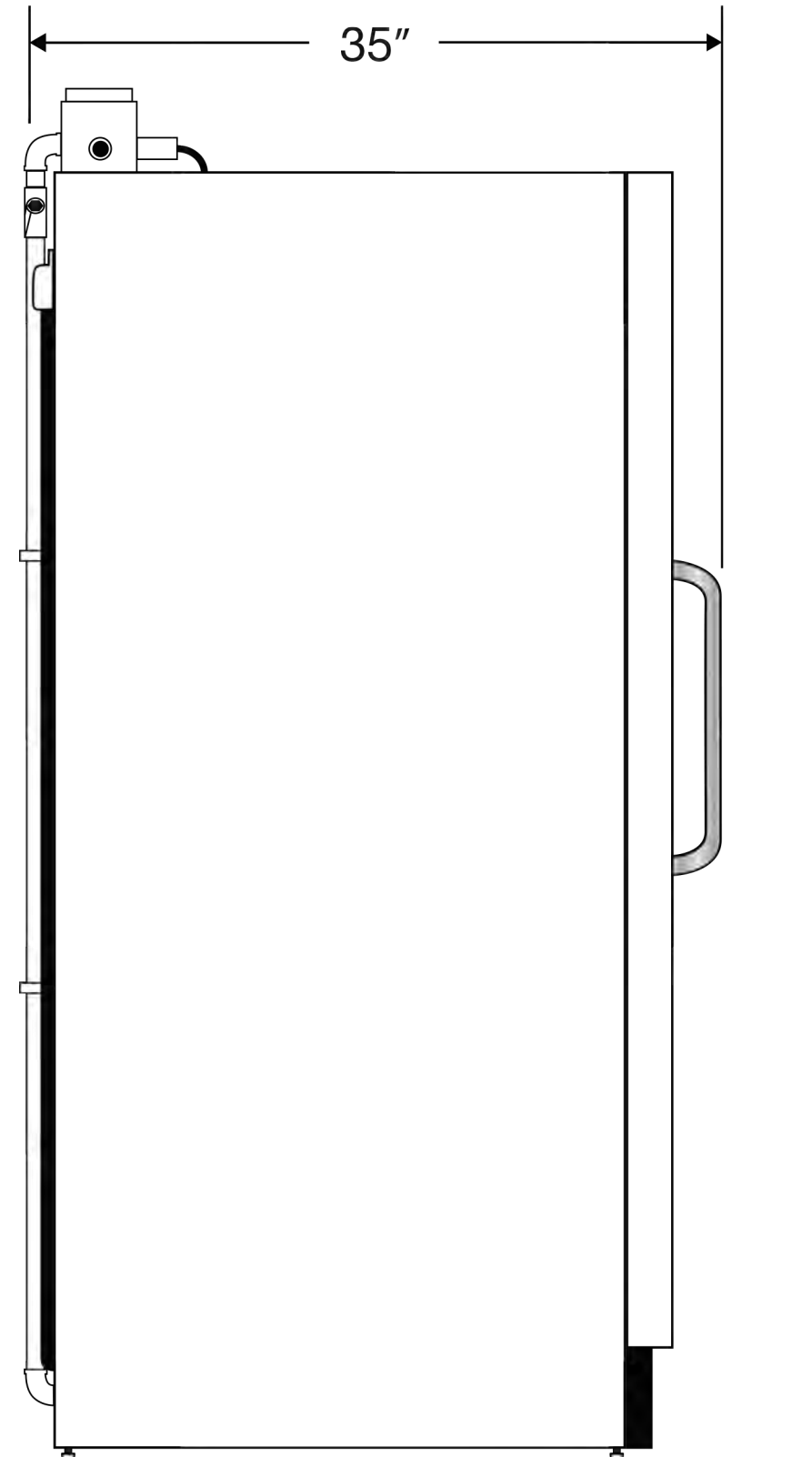

Side View



Top View

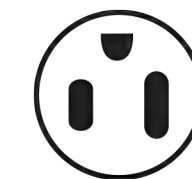
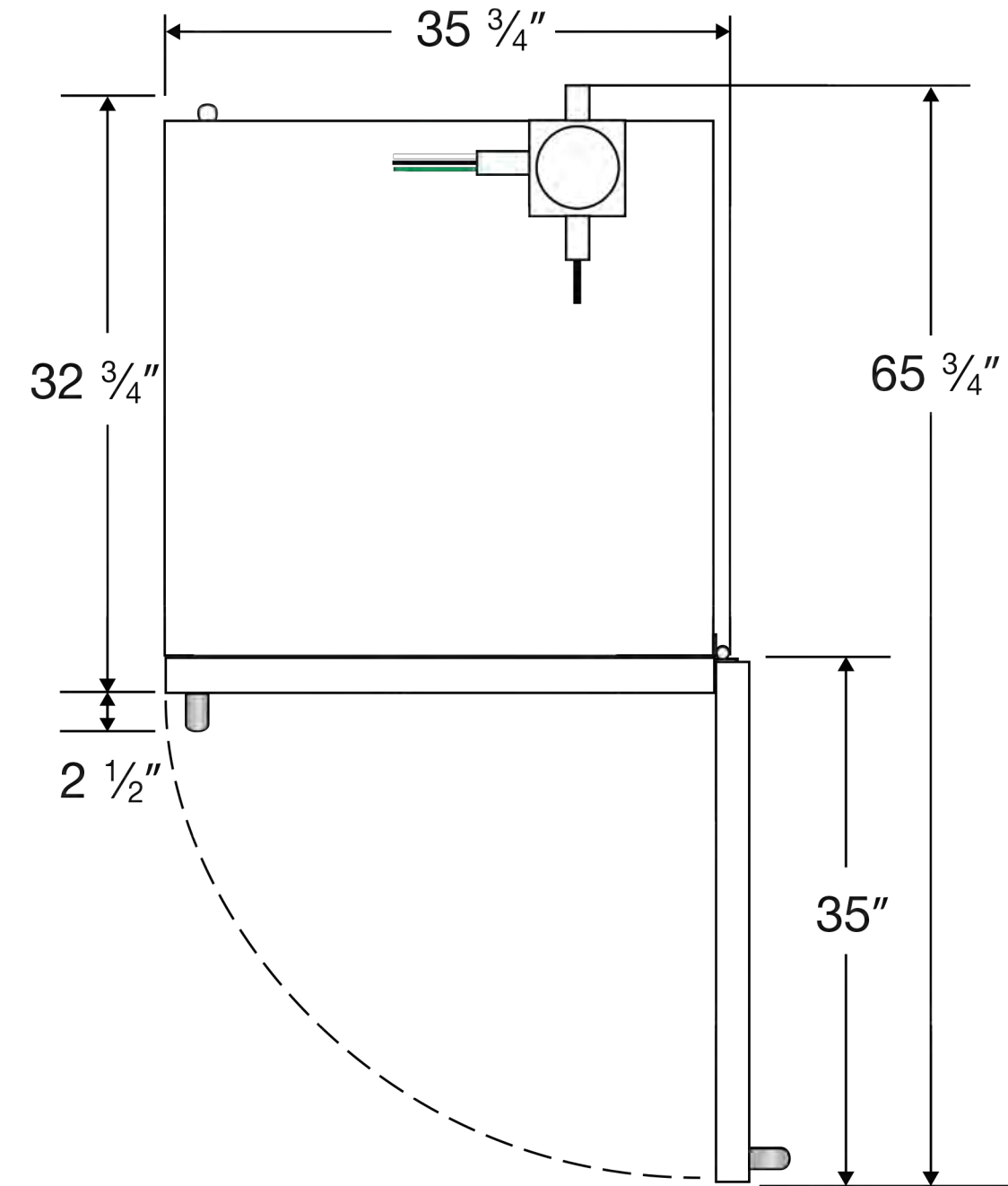

115VAC/60Hz/1PH  
NEMA-5-15P

Cu. Ft	Defrost	Door	Int Door	Shelves	W"	D"	H"	Refrigerant	H.P.	Amps	Weight
30	Manual	1 Solid	0	4 Fixed	35 3/4	35	77 1/2	R404a	1/3	6	330 lbs.