



# Instruction Manual for Torbal AGCN Series Balances





# Table of Contents

<a href="#">Chapter 1.Cautiounary Notes and precaution</a>	3
<a href="#">Chapter 2.Specifications</a>	4
<a href="#">Chapter 3.Keys and display indicators</a>	5
<a href="#">Chapter 4.Commands and Abbreviations</a>	6
<a href="#">Chapter 5.Parts Description</a>	7
<a href="#">Chapter 6.Unpacking the balance and Getting Started</a>	8
<a href="#">Chapter 7.Weighing</a>	10
<a href="#">7.1.1.Taring</a>	10
<a href="#">7.1.2.Clearing a Tare</a>	11
<a href="#">Chapter 8.Calibration</a>	12
<a href="#">8.1.1.Initializing Automatic Calibration</a>	12
<a href="#">8.1.2.Calibration Adjustment</a>	13
<a href="#">8.1.3.Calibration Time</a>	15
<a href="#">8.1.4.Calibration Temperature</a>	16
<a href="#">8.1.5.Calibration Report</a>	17
<a href="#">Chapter 9.Automatic Zero Setting Mechanism (AZSM)</a>	18
<a href="#">9.1.1.1.AZSM – Enable / Disable</a>	18
<a href="#">9.1.2.Configuration</a>	20
<a href="#">Chapter 10.Units of Measure</a>	22
<a href="#">Chapter 11.Parts Counting</a>	23
<a href="#">11.1.1.Using Default Sample Size Settings</a>	23
<a href="#">11.1.2.Using Custom Sample Size</a>	25
<a href="#">11.1.3.Counting based on a known Individual Piece Weight (No Sample Size Required)</a>	27
<a href="#">Chapter 12.Percent Weighing</a>	29
<a href="#">Chapter 13.Recipe Making and Totalizing</a>	31
<a href="#">Chapter 14.Density Calculation</a>	34
<a href="#">14.1.1.Solid</a>	35
<a href="#">14.1.2.Liquid</a>	38
<a href="#">Chapter 15.Printing and RS232 Communication Port Configuration</a>	42
<a href="#">15.1.1.Torbal Printer Configuration (RXP-4)</a>	42
<a href="#">15.1.2.Baud</a>	43
<a href="#">15.1.3.Parity</a>	44
<a href="#">15.1.4.Bits</a>	45
<a href="#">Chapter 16.Date and Time</a>	47
<a href="#">16.1.1.Time</a>	47
<a href="#">16.1.2.Date</a>	49
<a href="#">Chapter 17.Menu Customization</a>	51
<a href="#">Chapter 18.Common Errors and Troubleshooting</a>	52
<a href="#">Chapter 19.Maintenance</a>	53
<a href="#">Chapter 20.Accessories</a>	53
<a href="#">Chapter 21.Replacement Parts</a>	53
<a href="#">Chapter 22.Limited Warranty</a>	54



## Important handling Cautions and Warnings

Always handle your scale with care.

Damage caused by improper handling is not covered under the scale's warranty.



Never drop or throw any articles onto the scale's pan or onto any other parts of the unit!



DO NOT let the scale fall or drop from its tabletop surface!

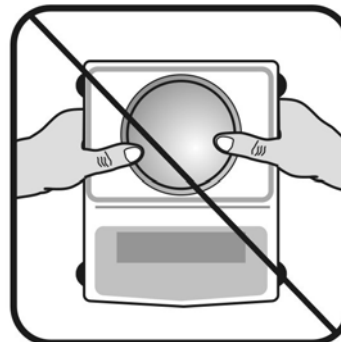

When moving the scale do not press or apply force onto the scales pan!



DO NOT pass or handle liquids directly over the scale to avoid spillage and liquid damage!

## CHAPTER 1.

# CAUTIONARY NOTES AND PRECAUTIONS

The TORBAL Precision scale is a sensitive and a delicate instrument. Always handle your scale with care.

The correct location and proper environment affect the accuracy of your TORBAL Precision Scale.

### The best location for your scale:

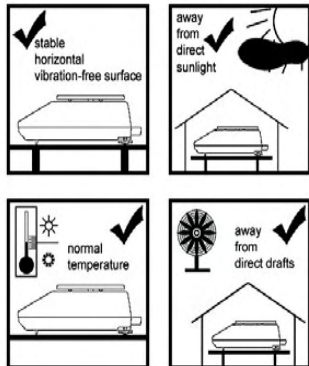

1. Stable, horizontal, vibration-free surface
2. Away from direct sunlight
3. Not exposed to high temperature variations
4. Away from direct drafts
5. The best location is on a stable bench away from drafts, doors, windows, radiators and air conditioner vents.

### CAUTION:



- The scale is designed for indoor use only.
- Do not operate the scale in hazardous areas or under dangerous conditions.
- Do not use the scale in locations subject to high humidity or dust levels.
- Do not connect cables in ways other than those mentioned in this manual.
- Set the scale on a firm, stable, horizontal surface.
- Never stand on or lean on this product. Equipment may fall or collapse, causing breakage and possible injury.
- Before moving the product, unplug it and unplug all cables connected to it.
- When storing, transporting or returning the scale for service, use the original packaging.

### WARNING:



- a. Never attempt to repair, disassemble or modify the scale. Tampering with the scale may result in injury and cause greater damage to the equipment.
- b. Never swap the pan, pan base, or any other parts of the scale with pans or parts from other units. Pans and all components are uniquely assigned to each unit.
- c. Be sure to use the specified power source.
- d. Do not allow foreign matter to fall into the scale.
- e. If water or other liquids spill into the scale, unplug the power cord immediately and contact technical support

TORBAL Precision scale is a sensitive and a delicate instrument. Always handle your scale with care.



## Chapter 2.

# SPECIFICATIONS

	Model	
	AGCN100	AGCN200
<b>Capacity</b>	100g	200g
<b>Readability (d)</b>	0.0001	
<b>Repeatability (Standard Deviation)</b>	0.0001g	
<b>Linearity</b>	+/- 0.0002g	
<b>Stabilization time (typical)</b>	Approx. 3 sec	
<b>Tare Range</b>	-100g	-200g
<b>Accuracy Class</b>	I	
<b>Automatic Internal Calibration</b>	YES	
<b>Time Configuration</b>	1h, 2,h, 3h, 4h, 5h, 6h	
<b>Temperature Configuration</b>	0.5°C, 1.0°C, 1.5°C, 2.0°C	
<b>Automatic Calibration Adjustment Masses (g)</b>	20,50, 100	50, 100, 200
<b>Pan Dimension</b>	90mm	
<b>Draft Chamber</b>	Standard	
<b>Scale Dimension</b>	216 x 345 x 347 mm	
<b>Operating Temperature</b>	+15°C to +30°C	
<b>RS232 Port</b>	Bidirectional	
<b>Power Supply</b>	Input: 120VAC 60Hz 15W Output: 12VDC 500mA	
<b>Display Type</b>	Seven Segment LCD with backlight	
<b>Display Size</b>	30mm x 100mm	
<b>Application Modes</b>	<a href="#">Weighing</a> , <a href="#">Parts Counting</a> , <a href="#">Percent Weighing</a> , <a href="#">Totalizing</a> , Density Calculation	
<b>Weighing Units</b>	Grams, Carats, Pounds	
<b>Scale's Net Weight (lb/kg)</b>	6.5kg/14.5lbs	
<b>Parts Counting</b>	<b>Sample Size</b>	5, 10, 20, 50, 100, 200, 500, Custom, Known Piece Weight
<b>Percent Weighing</b>	<b>% Resolution Displayed (Reference Weight)</b>	0.1% (10mg to 700mg), 0.01% (700mg to 7g) 0.001% (> 7g)



## Chapter 3.

# KEYS AND DISPLAY INDICATORS

Key	Primary Function	Secondary Function
∅	Power On and Power Off	-
T (YES)	Tare – used to tare the weighing pan	Enter and YES (Accept) – used to enter or accept commands
→0← (NO)	-	Toggle and scroll menu options
MENU	Menu – used to access the main menu	-
FUNCTION	-	Recall Total- In Totalizing this key is used to check the total weight of ingredients.
P	Print – used to initiate printing	Decimal – used for entering a decimal when assigning limit values in check-weighing
C	Calibration	-

Display Indicator	Description	Explanation
OFF	Power Off	The scale is turned OFF and in standby mode.
AUT	AZSM (Automatic Zero Setting Mechanism)	AZSM (Automatic Zero Setting Mechanism) is active and the scale maintains a “center of zero” condition within +/- 2d
NET	Net Result	A tare was taken and the scale subtracted the tare weight from the gross weight to obtain the net weight.
→0←	-	-
O	Current setting	Indicates enabled functions or settings.
MODE	Main Menu	Indicates Main Menu functions
▲▲	Stability Indicator	The weighing result has stabilized and an accurate reading may be taken.
Pcs	Pieces	In parts count this indicator shows that the result is a piece count
%	Percent	In percent weighing this indicator shows that the result is a percentage



## Chapter 4.

# COMMANDS AND ABBREVIATIONS

Command or Abbreviation	Description
-----	Taring in progress
CAL	The scale is in the calibration mode.
TARING	The scale is taring before the calibration process or a tare is required
CAL ON	Calibration has been initiated
CAL	Calibration adjustment in progress
LOAD XXX g	Indicates to load a calibration weight on the pan in order to begin calibration
UNLOAD	Remove the calibration weight
WAIT	Wait for calibration to finish
PRESS AGAIN	Press Again in order to initiate manual calibration.
CAL PRN	Start Calibration Report printout
AUTOTAR	Configure Automatic Zero Setting Mechanism
PCS SET	Custom Sample Size selection (Parts Counting)
PCS UM	Known Individual Piece Weight (Parts Counting)
PRINT	Printing in Progress
ACTIV	Main Menu customization command

## Chapter 5.

# PARTS DESCRIPTION

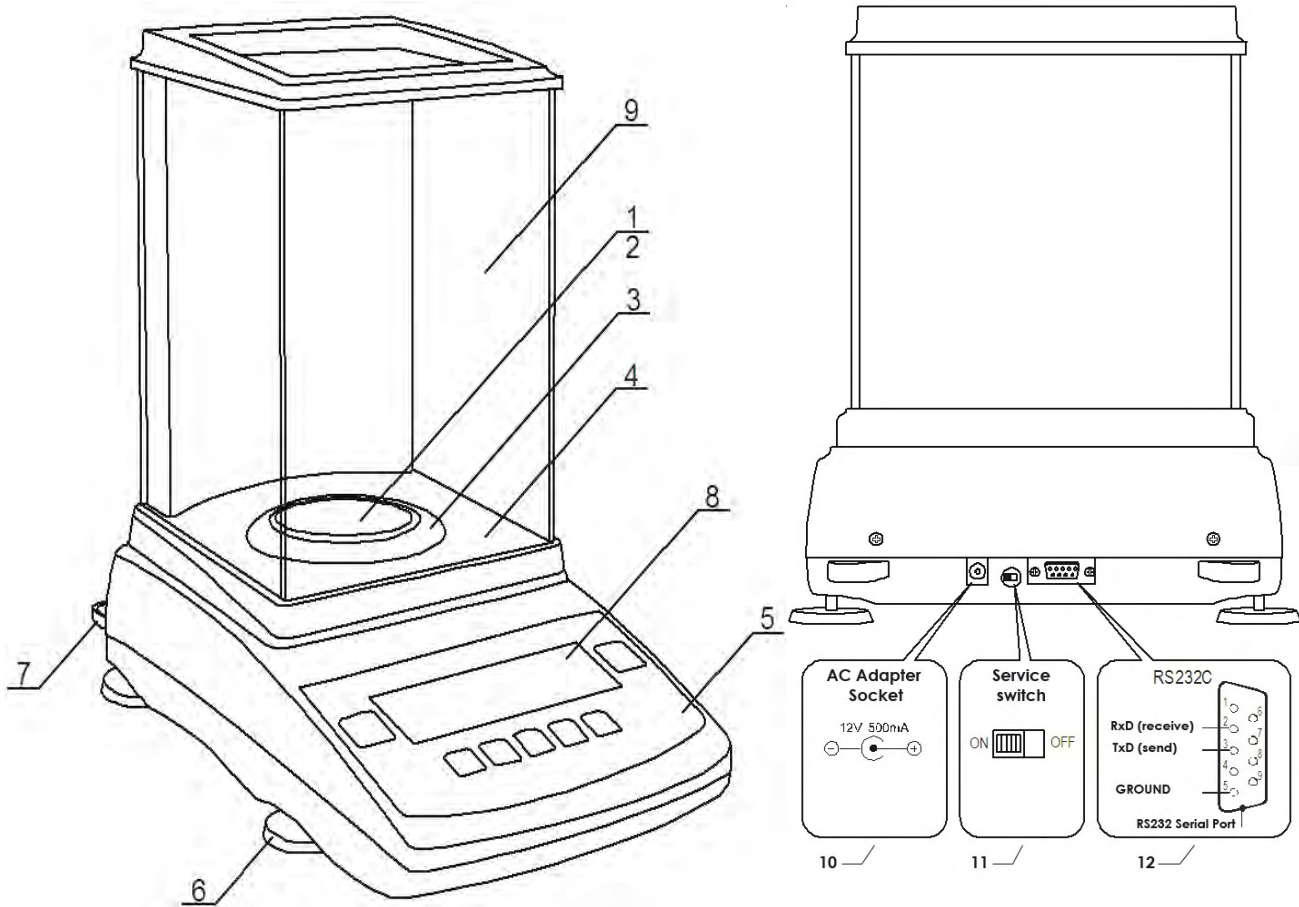

1	Pan
2	Pan Base
3	Draft Ring
4	Weighing Chamber Base
5	Keypad
6	Adjustable Legs
7	Level Indicator
8	LCD Display
9	Weighing Chamber
10	AC Adapter Socket
11	Service Switch
12	RS232 Serial Port



## Chapter 6.

# UNPACKING THE BALANCE AND GETTING STARTED

1. Carefully remove the scale, pan, and all of its components out of the packaging and place them on a stable base where the scale will not be affected by any mechanical vibrations or air movements.
  
2. After removing the chamber base (4), draft ring (3), pan base (2), and the pan (1) from their packaging, carefully install the chamber base (4) on the case of the balance as shown below. Once the chamber base is in place, install the draft ring (3). Once components 4 and 3 are in place install the pan base onto the scale by placing it on the pan support located in the middle of the scale. Once the pan base has been installed, carefully place the pan on the base as shown below.

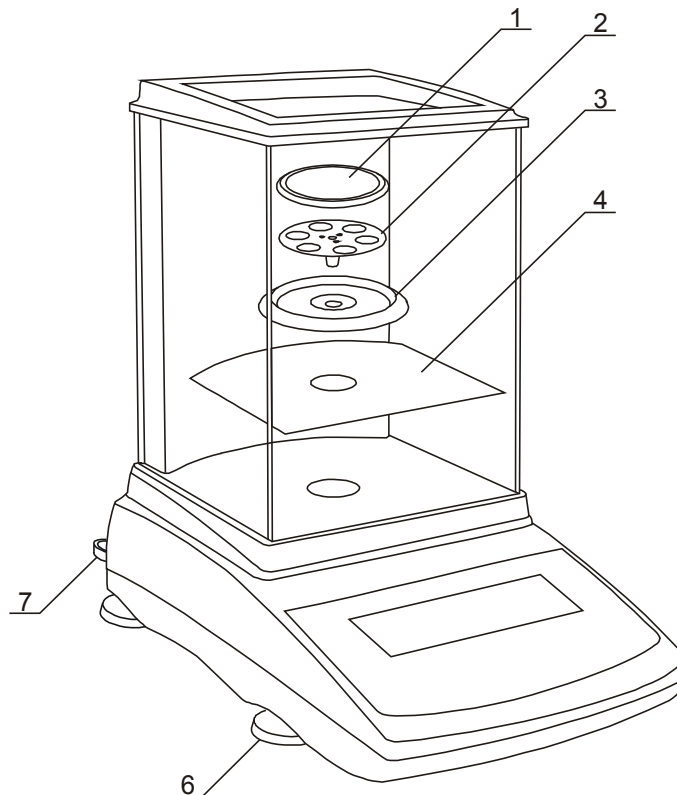

- Once the pan has been installed, level the scale by adjusting the rear feet until the level indicator shows the “air bubble” is in the center position of the sight glass. The level indicator is located in the rear left side of the scale.

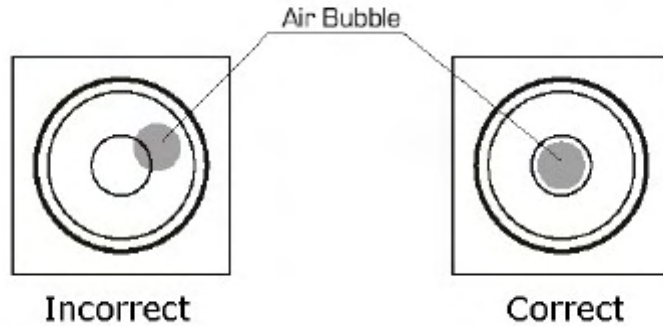

- After leveling the scale, you may plug the AC adaptor to the AC adaptor socket located in the rear of the scale.



- When the AC adaptor is plugged into the wall outlet, the scale will turn “ON” automatically, initialize itself, perform automatic internal calibration and enter weighing mode.
- To put the scale into standby mode, leave the AC adaptor plugged into both the scale and the wall outlet and press the Power “OFF” button (| / ⏻). The “OFF” indicator will light up in the upper left corner of the display signaling the scale is in standby mode.

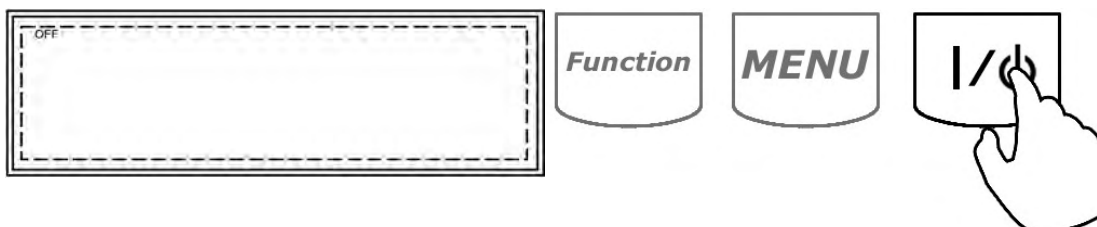

## Chapter 7.

# WEIGHING

1. To begin weighing, press the power button ( | / ⏻ ) to turn the scale ON. The scale will go through its initialization procedure and automatically enter Weighing Mode. The scale is ready to begin weighing as soon as the stabilization (  ) indicator appears on the display.



2. When weighing, always place the mass in the middle of the pan. The weighed result may be taken when the stabilization indicator appears on the display.



### 7.1.1. Taring

1. If a container is used for weighing, it may be tared. In taring the container, the scale subtracts the weight of the container from the gross weight to obtain the net weight.
2. To tare the weighing container, place it in the middle of the pan. The container's weight will be shown on the display.

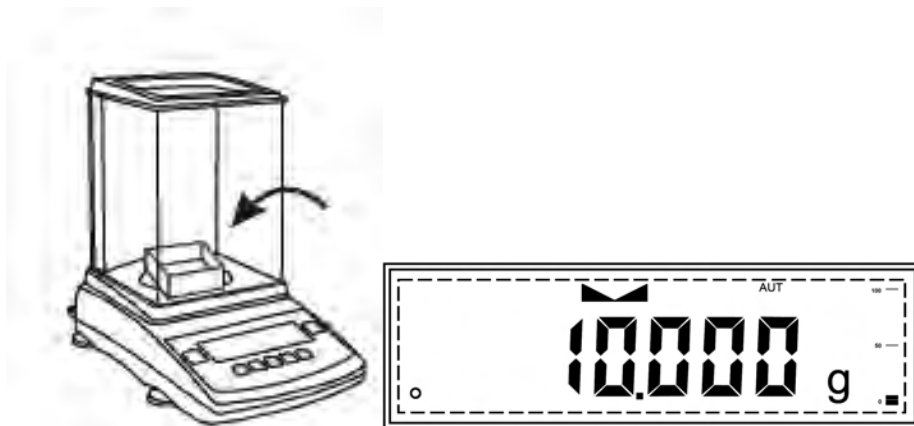

- Once the stabilization indicator appears on the display, the container is ready to be tared. To tare the container, press the “T” button. The display will show a dotted line which indicates the scale has begun the taring process,

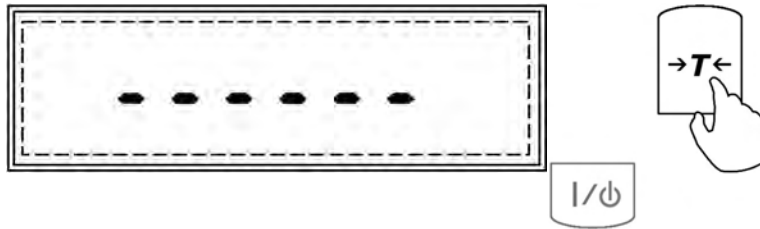

- When finished taring, the balance will return to Weighing Mode. The display will indicate 0.0000, and the NET indicator will be shown on the display signaling the next weight taken is a NET result.

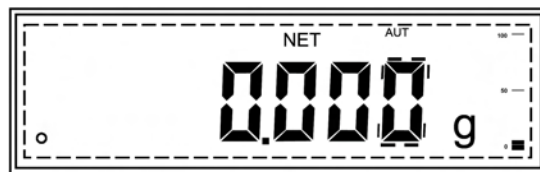

### 7.1.2. Clearing a Tare

- To clear the tare, remove the tared object along with the NET weight from the pan. The scale will then display a negative NET tare result.



- To clear the tare, press the T button.

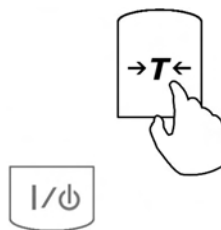

- The display will show dashed lines indicating the tare is clearing.

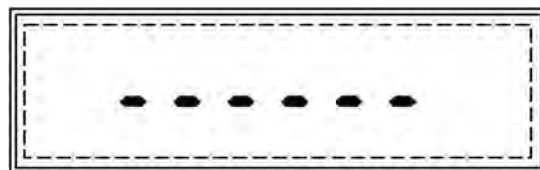

- When finished clearing the tare, the scale will return to Weighing Mode.

## Chapter 8.

# CALIBRATION

When the scale is initially installed, it will automatically calibrate at start up to ensure the accuracy of weighing results. You can also configure the scale to calibrate automatically with time and temperature variations.

### 8.1.1. Initializing Automatic Calibration

To calibrate the scale at any time, follow these steps:

1. Press the calibration key located on the scales front panel.

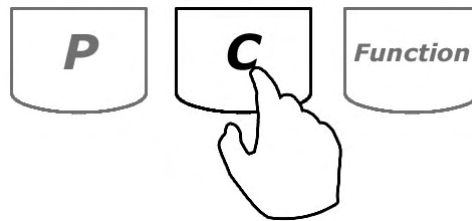

2. Command “PRESS AGAIN” will be displayed sequentially for approximately 5 seconds.

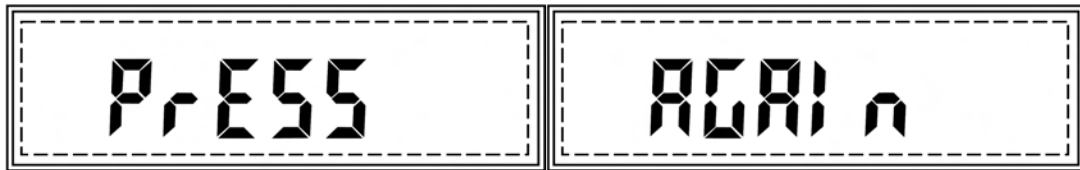

3. While the command “PRESS AGAIN” is displayed, press the calibration key once more.

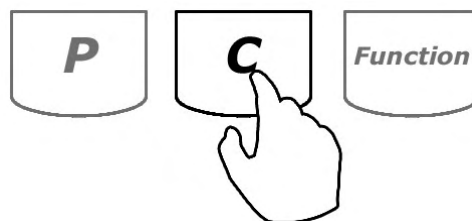
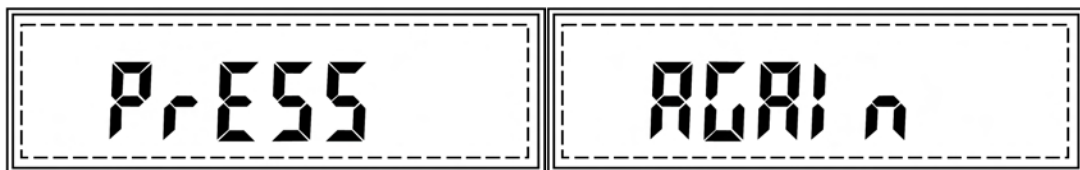

- The scale will display “WAIT”, indicating that automatic calibration has begun.



- Calibration can last from 30 to 50 seconds. When it is finished, the scale will automatically return to the weighing mode.

### 8.1.2. Calibration Adjustment

The calibration adjustment function allows the internal calibration mass value to be adjusted with an external calibration weight that has a traceable class certification. To perform calibration adjustment, follow these steps:

- Enter the main menu by pressing the MENU key.

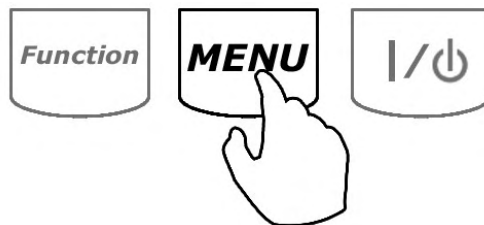

- Enter the calibration set up by pressing the T Key when “CALIBR” is displayed.

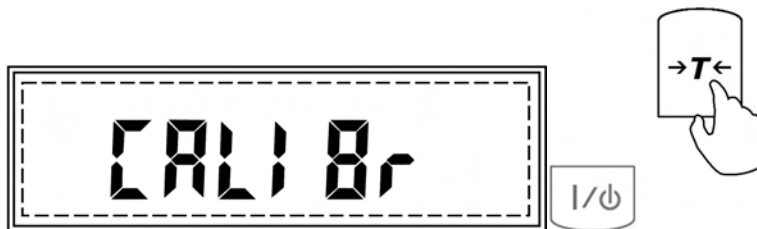

- Press the T Key again when “CAL ON” is displayed.



4. Calibration mass value settings which can be used for calibration adjustment will be displayed sequentially. Press the T Key when the desired external calibration mass value is displayed.

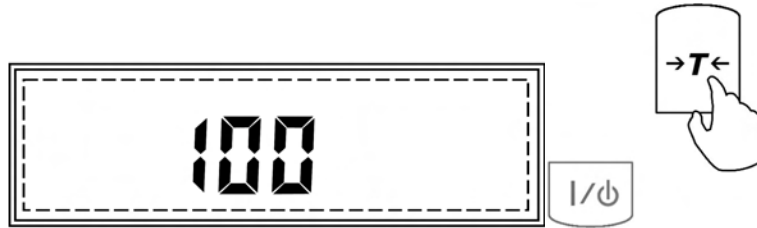

5. The scale will display “CAL”, indicating the calibration adjustment has been entered.



6. Before calibration adjustment can begin, the scale will perform automatic tare. Dashed lines “-----” will be displayed during auto tare.

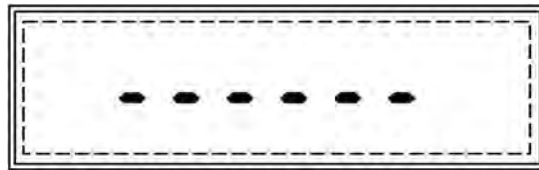

7. Once the scale has been tared, the command “LOAD” will be displayed. At any time during the “LOAD” command, place the single calibration weight in the middle of the pan.



8. Command “CAL” will be displayed, indicating that the scale is recording a new calibration mass value.

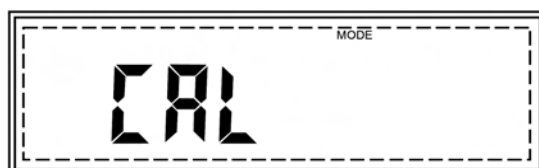

- Once the new calibration value is stored, the command “UNLOAD” will be displayed, indicating that this calibration weight should be removed from the pan.

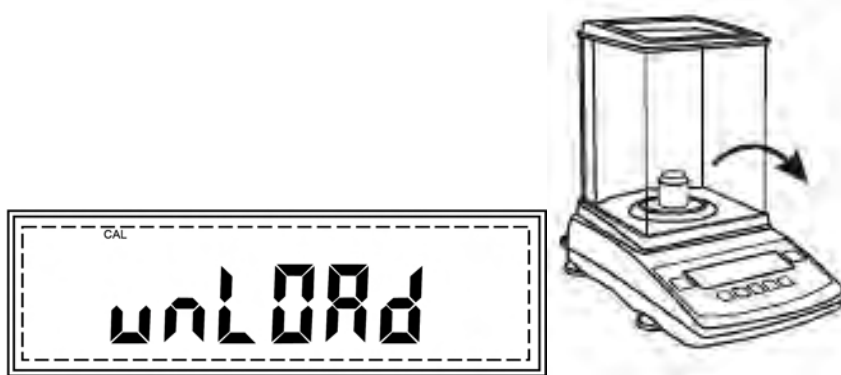

- Once the weight is removed, the scale will continue with calibration adjustment. “WAIT” will be displayed during the remainder of the adjustment process. Once finished, the scale will automatically return to the weighing mode.



### 8.1.3. Calibration Time

Internal calibration can be configured to calibrate automatically after a set interval of time. To set a calibration time interval, follow these steps:

- Enter the main menu by pressing the MENU key.

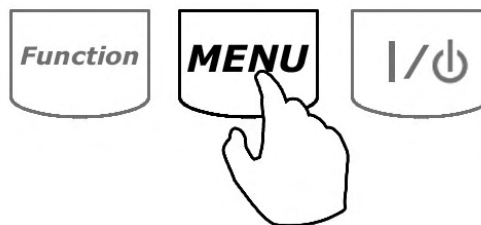

- Enter calibration set-up by pressing the T Key when “CALIBR” is displayed.





3. Press the T Key again when “CAL TM” is displayed.

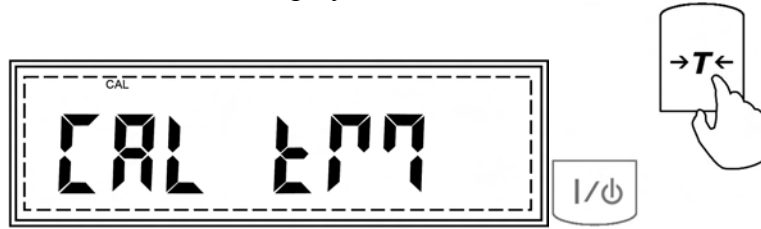

4. Time interval settings will begin to display sequentially. The current time interval setting will be marked with “o” located in the lower left corner of the display.
5. Automatic calibration can be set to calibrate between 1, 2, 3, 4, 5, and 6 hours (i.e., if set to 3, calibration will be performed at least once every three hours).
6. To select a time interval, press the T Key when the desired setting is displayed. To disable the time interval calibration, press the T Key when OFF is displayed.

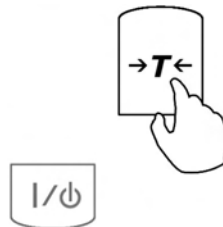

### 8.1.4. Calibration Temperature

Internal calibration can be configured to calibrate automatically within a change of temperature. To set a calibration temperature interval, follow these steps:

1. Enter the main menu by pressing the MENU key.

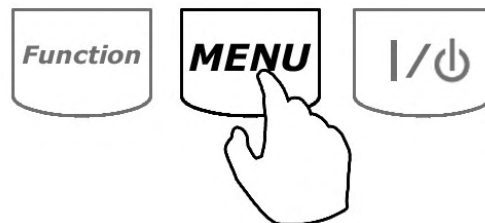

2. Enter the calibration set-up by pressing the T Key when “CALIBR” is displayed.

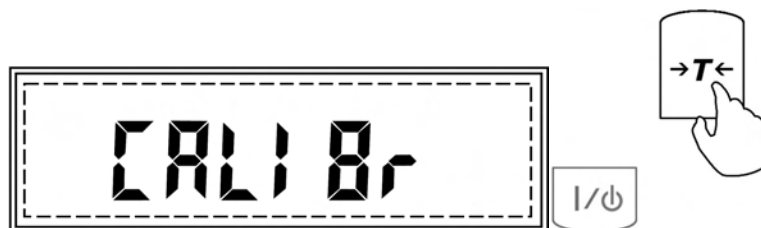

3. Press the T Key again when “CAL °C” is displayed.



4. Temperature interval settings will begin to display sequentially. The current temperature interval setting will be marked with “o” located in the lower left corner of the display.
5. Automatic calibration can be set to 0.5°C, 1.0°C, 1.5°C, and 2.0°C (i.e., if set to 2.0°C, calibration will be performed every time the temperature changes by 2.0°C).
6. To select a temperature interval, press the T Key when the desired setting is displayed. To disable temperature calibration, press the T Key when OFF is displayed.

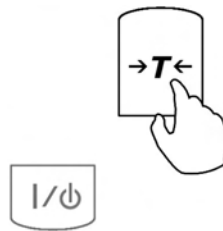

### 8.1.5. Calibration Report

After calibration set-up and adjustment have been completed, a calibration report can be printed. The calibration report includes calibration data such as the current as well as factory internal and external weights. To print the calibration report, follow these steps:

1. Press MENU to enter the main menu.

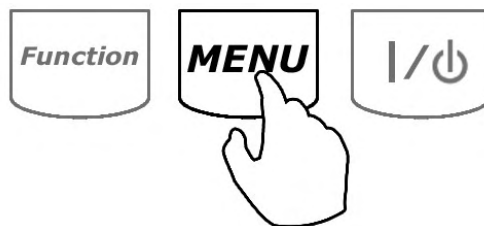

2. When command “CALIBR” is displayed, press the T key.

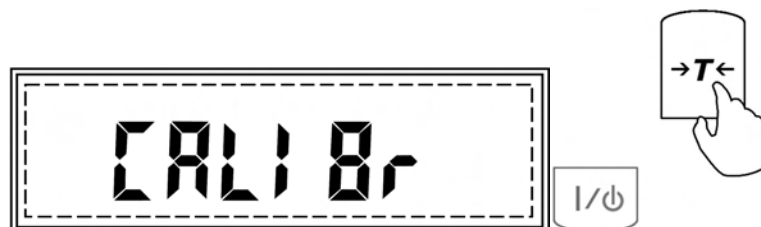

3. Press the T key again when command “CAL PRN” is displayed.

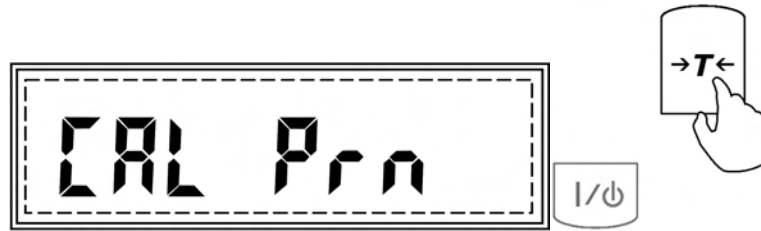

4. Command “PRINT” will be displayed indicating that data has been sent to an external printer or a PC via the RS232 communication port. For more on printing set-up and configuration, please turn to chapter 15.

## Chapter 9.

# AUTOMATIC ZERO SETTING MECHANISM (AZSM)

All AGCN scales are equipped with AZSM, the “Auto Zero Setting Mechanism.” AZSM automatically maintains a “center of zero” condition within +/- 2d.

### 9.1.1.1. AZSM – Enable / Disable

To enable or disable AZSM, follow these steps:

1. Enter the main menu by pressing the MENU key.

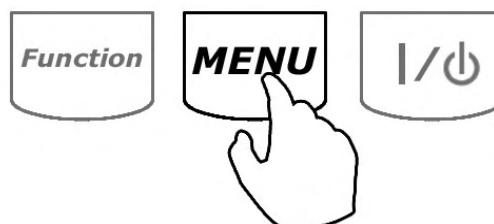

2. When command “AUTOTAR” is displayed, press the T key.

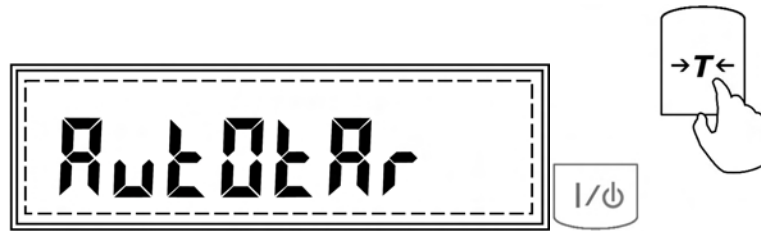

3. Commands “AUT ON”, “AUT OFF”, and “AUT SET” will be displayed sequentially.

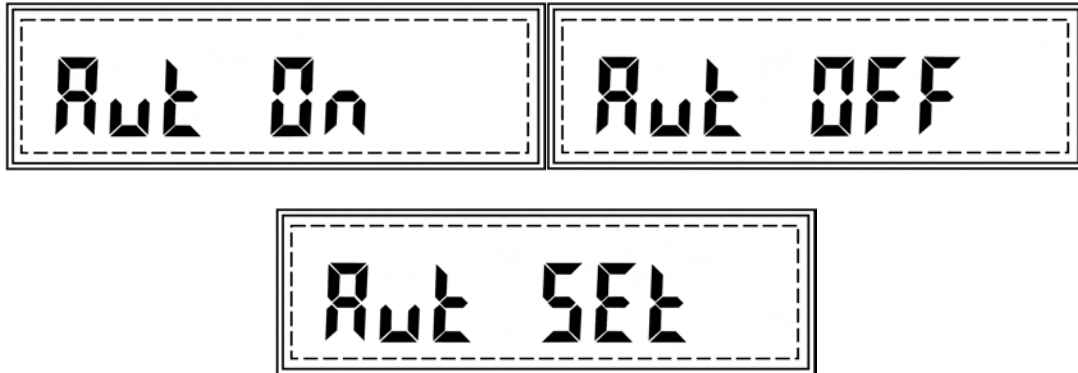

4. To enable AZSM, press the T key when AUT ON is displayed.



5. To disable AZSM, press the T key when AUT OFF is displayed.



Note: AZSM is automatically enabled for 10 minutes after the scale is turned ON, regardless of its ON/OFF configuration.

### 9.1.2. Configuration

The AZSM range can be configured to work between 0.1d and 5d. To change the AZSM range, follow these steps:

1. Enter the main menu by pressing the MENU key.

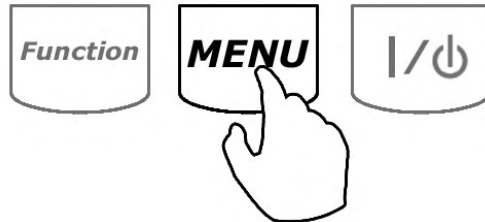

2. When command “AUTOTAR” is displayed, press the T key.

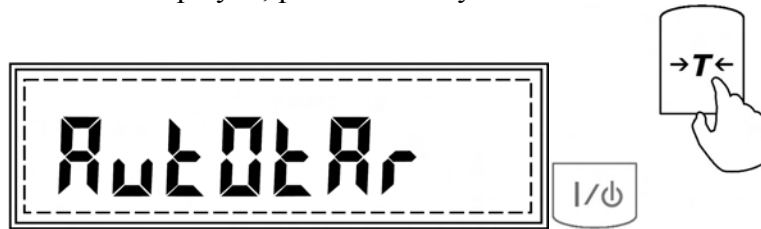

3. Commands “AUT ON”, “AUT OFF”, and “AUT SET” will be displayed sequentially.



4. Press the T key when command “AUT SET” is displayed.

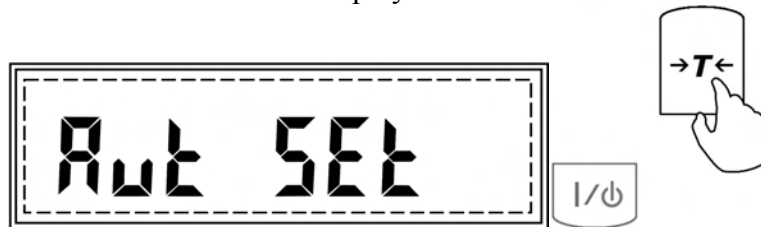

5. Default AZSM setting will be displayed followed by the “OUT” command. To exit AZSM configuration, press the T key when “OUT” is displayed. To change AZSM value, press the T key when the current AZSM value is displayed (i.e., 2.0).

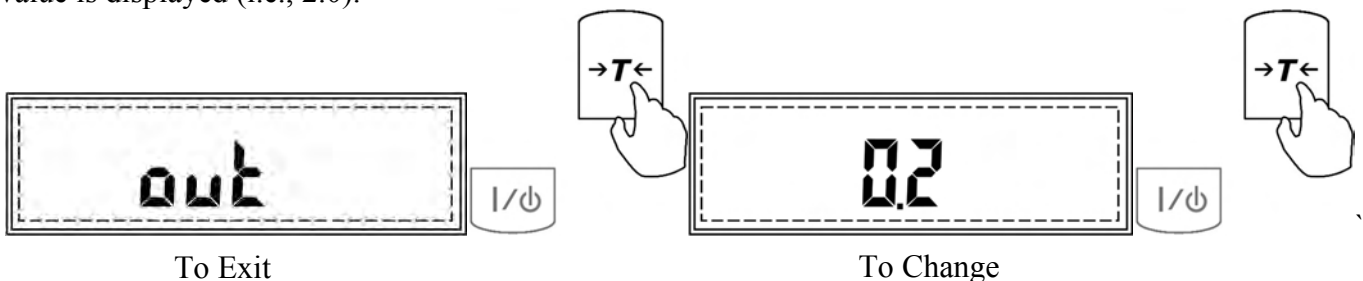

6. After the T key is pressed, in order to set a new AZSM range a dash will be displayed indicating a new AZSM value between 0.1d and 5d should be entered.

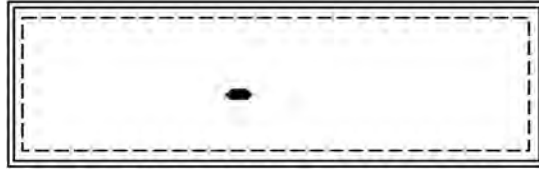

7. To enter a new AZSM value, use the following keys: the C key to increment a digit, the T key to accept and go to the next digit, the P key to insert a decimal, and MENU to accept the entire setting.

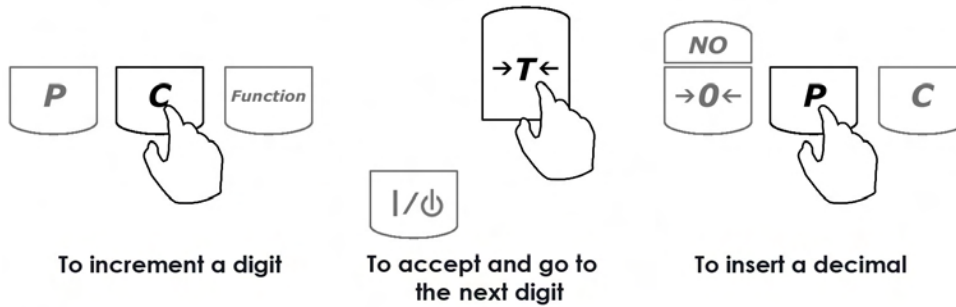

## Chapter 10.

# UNITS OF MEASURE

The AGCN Series Scales can operate in three different units of measure: Grams (g), Carats (ct), and Pounds (lb). By factory default, the scale is set to weigh in grams (g). To select a different unit of measure, follow the steps below.

1. Enter the main menu by pressing the MENU key.

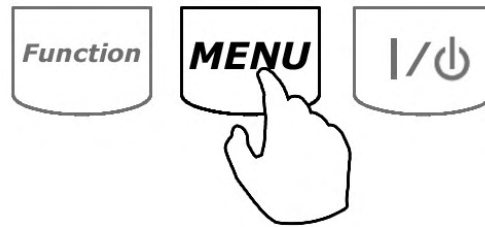

2. When command "UNITS" is displayed, press the T key.

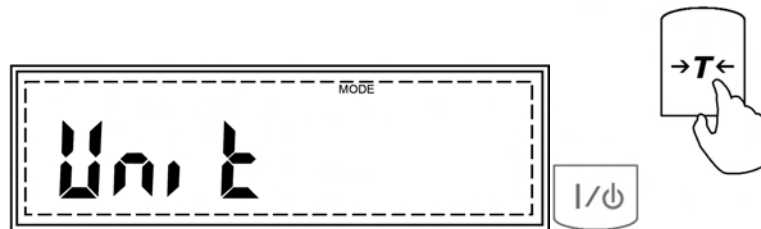

3. The scale will display available units of measure sequentially.
4. When the desired unit is displayed, press the T key to make the selection.

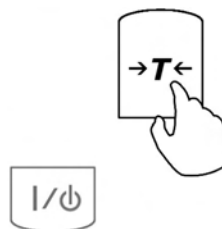

5. Once the selection is made, the scale will automatically return to the weighing mode.

## Chapter 11.

# PARTS COUNTING

### 11.1.1.Using Default Sample Size Settings

1. Place a container on the scale's pan and press the T key to tare.

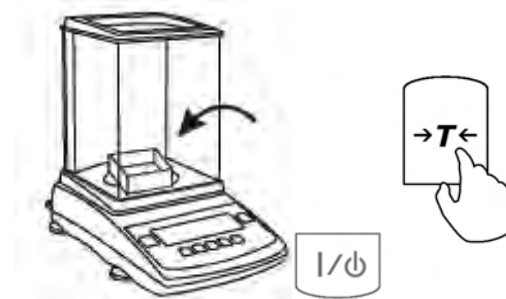

2. After taring the container manually, count out the sample that you wish to be used for calculating the average piece weight of your counting transaction. Use one of the following sample sizes: 5, 10, 20, 50, 100, 200, and 500.
3. Place the sample in the container.

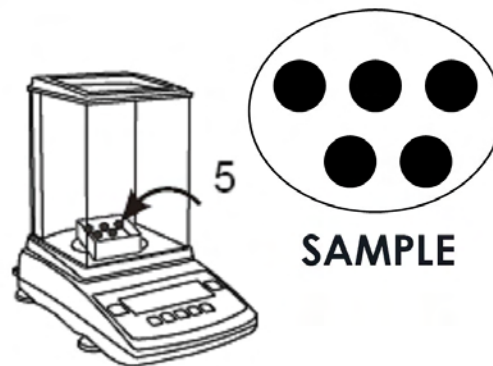

4. The weight of the sample will be displayed as it is placed on the pan. Once the weight of the sample stabilizes and the stability indicator appears on the display, press the MENU key to enter the main menu.

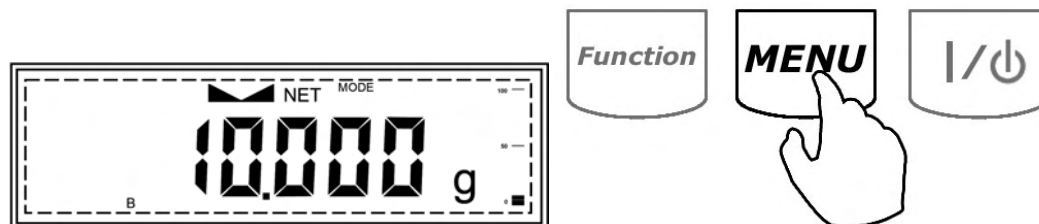



5. When “PCS” is displayed, press the T key.



6. Commands “PCS OFF” and “PCS ON” will be displayed sequentially. To proceed with parts counting, press the T key when command “PCS ON” is displayed.



7. The sample size selections will begin to scroll on the display. Press the T key when the sample size is displayed that is equal to the number of the pieces in the container (i.e., if you have placed 10 pieces as the sample for your counting transaction, press the T key when “PCS 10” is displayed).

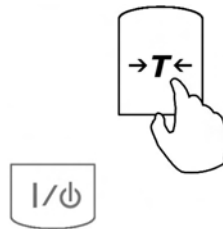

8. After the sample size has been selected, the scale will display the count of the sample. At any time you can proceed with the count.

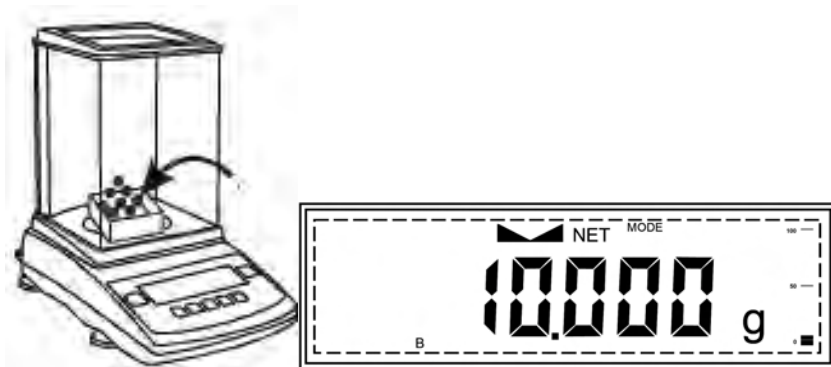

9. Once an accurate count has been taken, the container and its contents may be removed from the scale.

To exit parts counting and return to basic weighing, select “PCS OFF” from the parts counting menu.

### 11.1.2.Using Custom Sample Size

1. Place a container on the scale's pan and press the T key to tare. After taring the container manually, count out the sample that you wish to be used for calculating the average piece weight of your counting transaction.

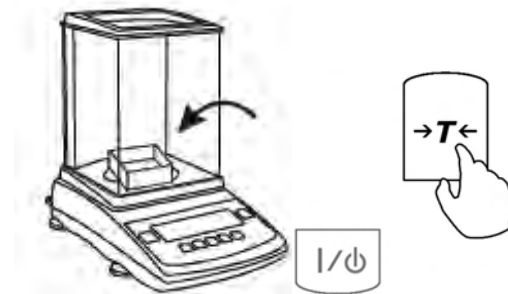

2. Place the sample in the container.



3. The weight of the sample will be displayed as it is placed on the pan. Once the weight of the sample stabilizes and the stability indicator appears on the display, press the MENU key to enter the main menu.

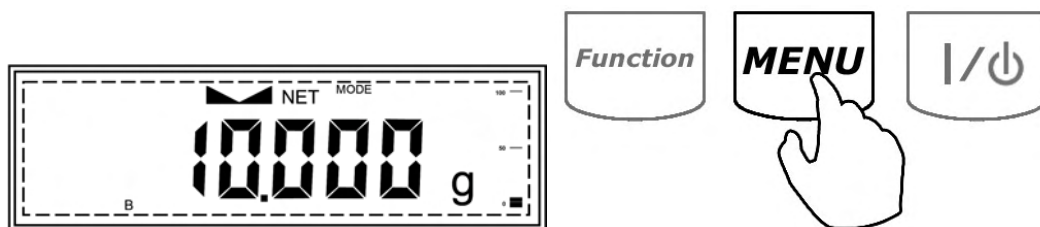

4. When "PCS" is displayed, press the T key.

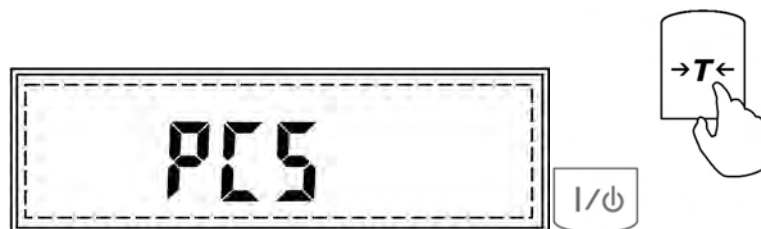

5. Commands “PCS OFF” and “PCS ON” will be displayed sequentially. To proceed with parts counting, press the T key when command “PCS ON” is displayed. The sample size selected will begin to scroll on the display.



6. Press the T key when PCS SET is displayed.



7. A dashed line will be displayed indicating to manually enter the value for your sample size in the container. To do so, use the following keys: the C key to increment a digit, the T key to accept and go to the next digit, and MENU to accept the entire setting.

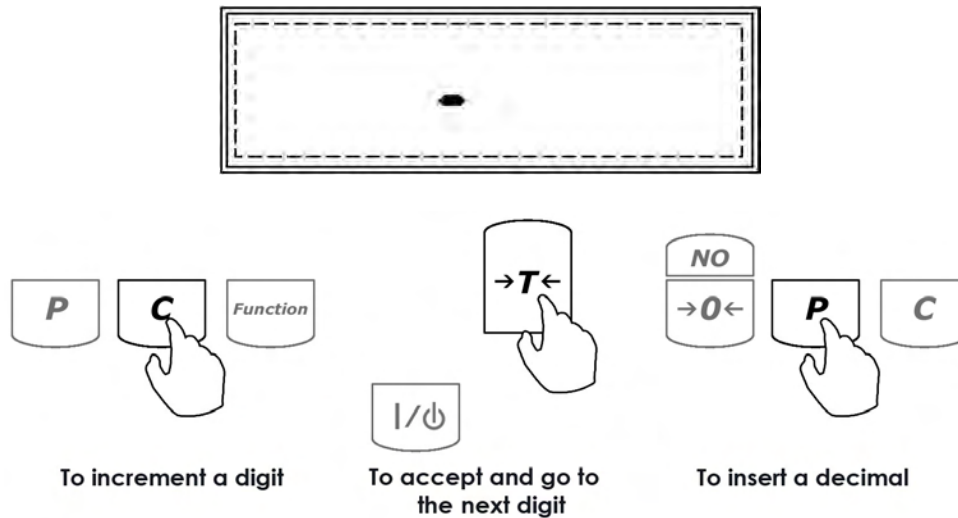

- Once your custom sample size value has been entered and the MENU key pressed, the scale will display the count of the sample. At any time you can proceed with the count.

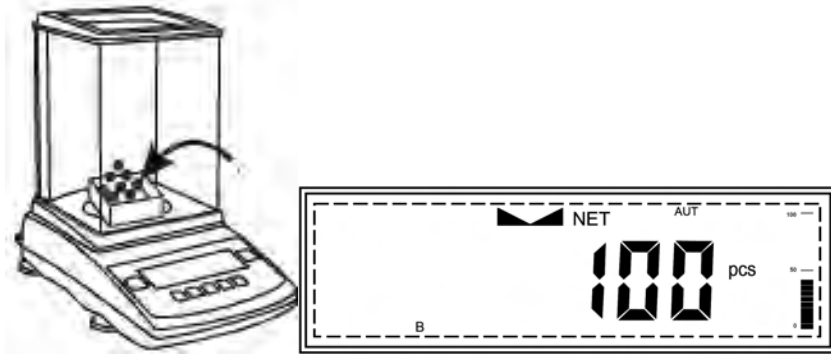

- Once an accurate count has been taken, the container and its contents may be removed from the scale.

### 11.1.3.Counting based on a known Individual Piece Weight (No Sample Size Required).

- Place a container on the scale's pan and press the T key to tare.

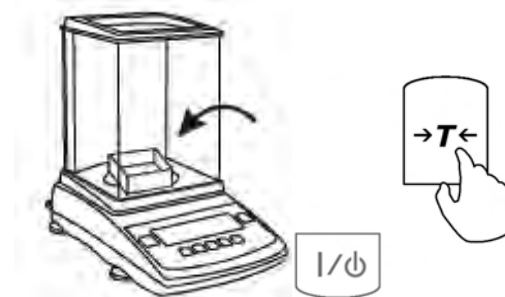

- Press the MENU key to enter the main menu.

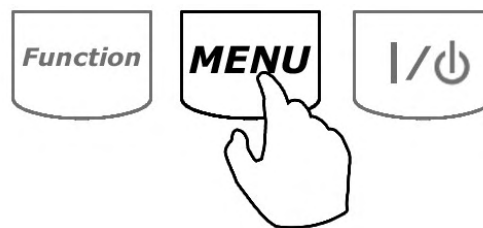

- When PCS is displayed, press the T key.

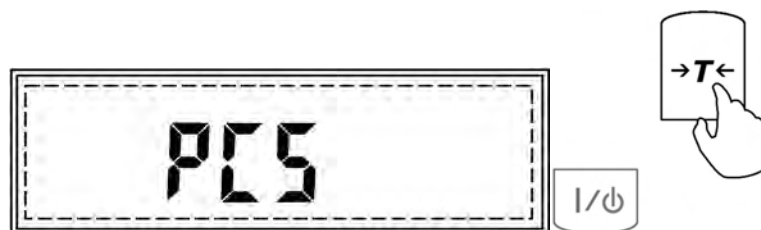

4. Commands “PCS OFF” and “PCS ON” will be displayed sequentially. To proceed with parts counting, press the T key when the command “PCS ON” is displayed.



5. Press the T key when command “PCS UM” is displayed.



6. A dashed line will be displayed indicating to manually enter the exact individual piece weight of the counted parts. To manually enter the individual piece weight, use the following keys: the C key to increment a digit, the T key to accept and go to the next digit, the P key to insert a period, and the MENU key to accept the entire setting.

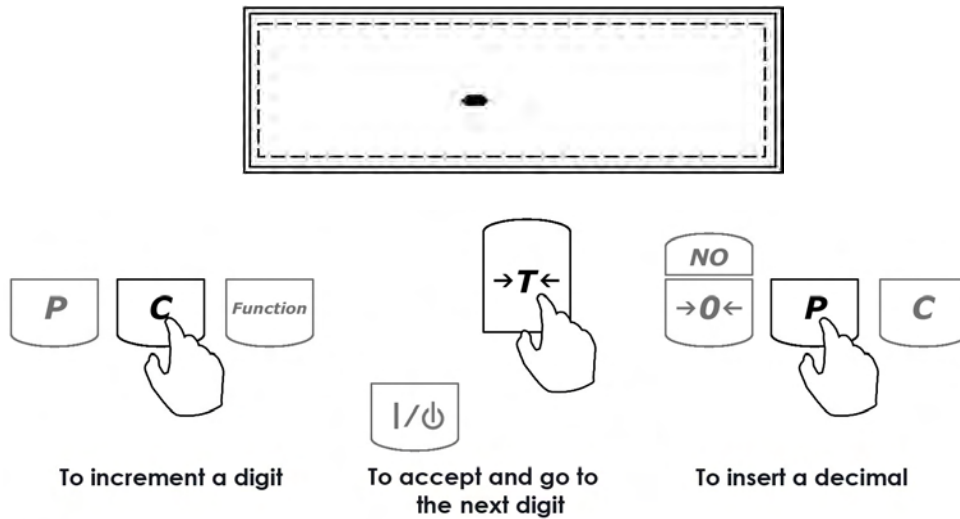

- Once the individual piece weight is entered and the MENU key pressed, the scale will display “0pcs”. At any time proceed with the count.

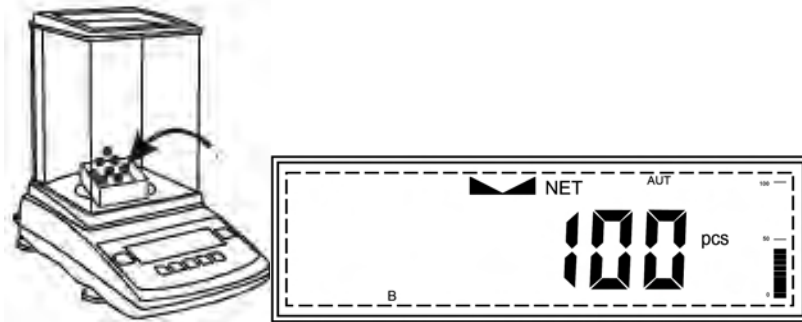

- Once an accurate count has been taken, the container and its contents may be removed from the scale.  
To exit parts counting and return to basic weighing, select “PCS OFF” from the parts counting menu.

## Chapter 12.

# PERCENT WEIGHING

Percent weighing is used to express the weight of an object as a percentage of a stored sample weight. To use percent weighing, follow these steps:

- Place container on the pan and press the T key to tare.

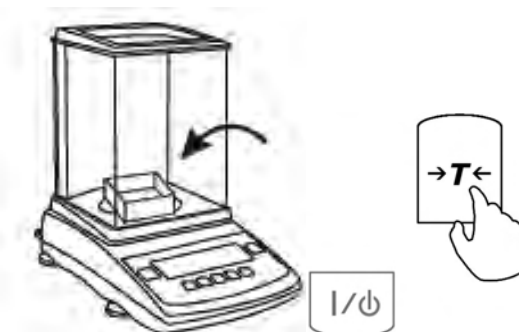

- Once the scale has been tared, place the sample reference weight on the pan.

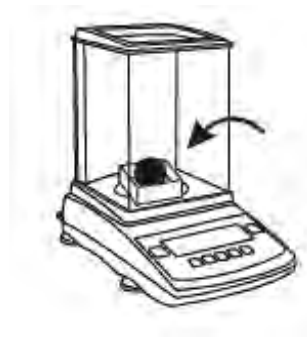

- A -  
Reference Weight

- The weight of the sample will be displayed as it is placed on the pan. Once the weight of the sample stabilizes and the stability indicator appears on the display, press the MENU key to enter the main menu.

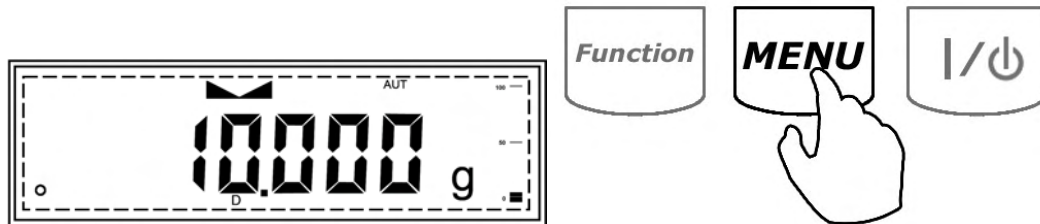

- When "PERCENT" is displayed, press the T key.



- Commands "PER OFF" and "PER ON" will be displayed sequentially. To proceed with percent weighing and set the reference sample weight, press the T key when command "PER ON" is displayed.



- Once the reference sample weight is set, the scale will express the weight as a percentage.

- Remove the sample and place an object in the container. The scale will express the weight of that object as a percentage of the stored sample.

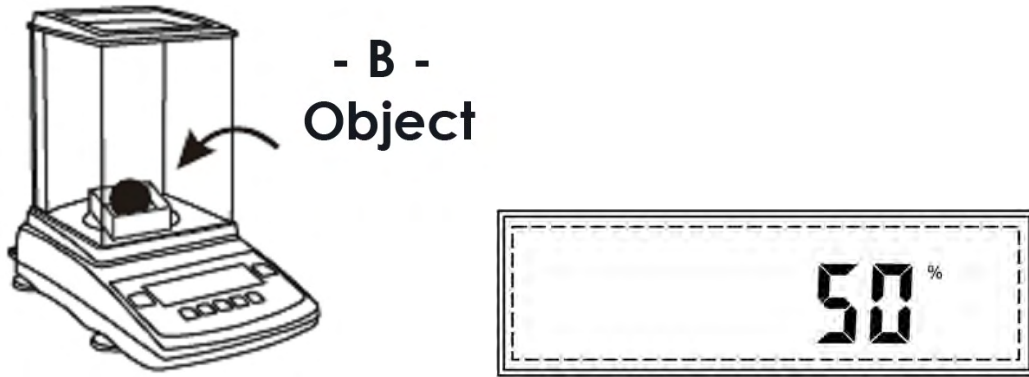

To exit percent weighing and return to basic weighing, select “PER OFF” from the percent menu.

## Chapter 13.

# RECIPE MAKING AND TOTALIZING

To engage in recipe making and totalizing, follow these steps:

- Place a container on the scale’s pan and press the T key to tare.

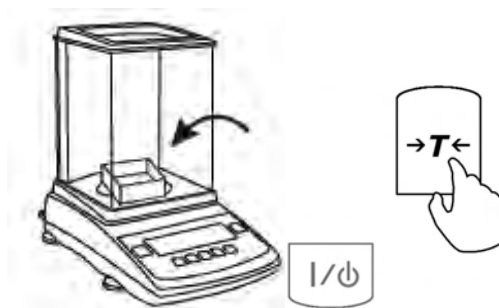

- Press the MENU key to enter the main menu.

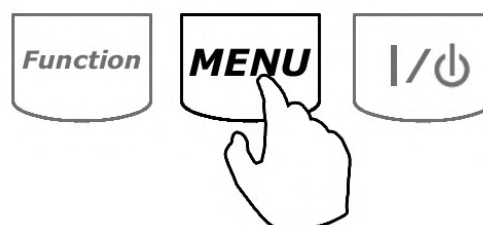



3. When “RECIPE” is displayed, press the T key.

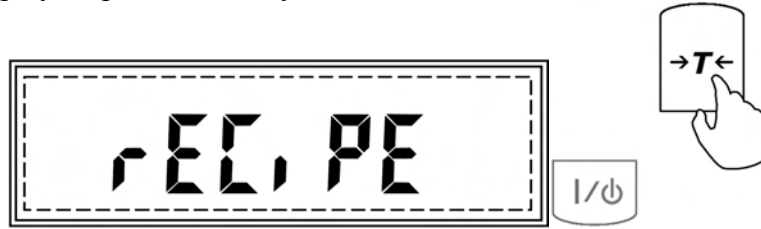

4. Commands “REC OFF” and “REC ON” will be displayed sequentially. To proceed with recipe making and totalizing, press the T key when command “REC ON” is displayed.



5. Once totalizing is enabled, the scale will return to the weighing mode and “o” will appear in the lower left corner of the display indicating that totalizing may begin.
6. Place the first ingredient in the container.

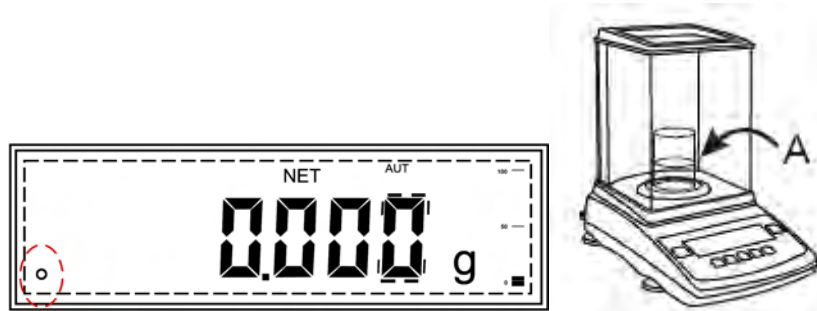

7. Once the weight of the ingredient stabilizes and the stability indicator appears on the display, press the T key.

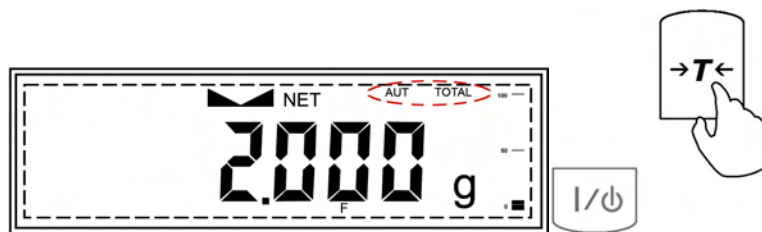

The weight of the ingredient will be tared and stored in the scale’s internal memory.

8. The scale will read zero indicating it is ready to receive the next ingredient.

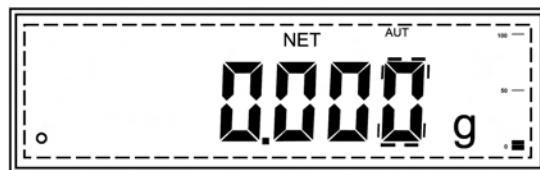

9. Place a second ingredient in the container, wait until the weight stabilizes, and press the T key to tare. The weight of the second ingredient will be added to the grand total and stored in the scale's internal memory.



10. To check the total weight of the ingredients at any time, press the FUNCTION key. The SUM indicator and the total weight of the ingredients in the container will appear on the display. To clear the total, press the T key when the SUM indicator is displayed. To return to totalizing and add more ingredients, press the FUNCTION key once again.

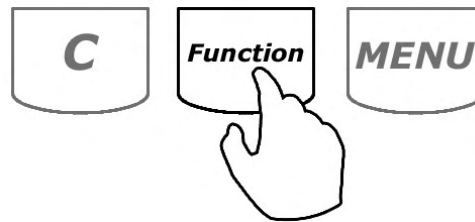

11. To add more ingredients, repeat steps 6 through 9. To exit totalizing, select "REC OFF" from the recipe function menu.



## Chapter 14.

# DENSITY CALCULATION

The density calculation feature is used to assist in calculation of density in solids and liquids. To perform density calculation, a Density Kit (part no. AGC9171) is required.

To calculate density of a solid the following formula is used:

$$\rho = \frac{m_1}{m_1 - m_2} * \rho$$

$m_1$  – mass calculation in air

$m_2$  – mass calculation in liquid

To calculate density in liquid the following formula is used:

$$\rho = \frac{m_1 - m_2}{V}$$

$m_1$  – mass of the plunger in air

$m_2$  – mass of the plunger in liquid

$V$  – Volume of the plunger

### 14.1.1.Solid

To calculate the density of a solid, follow these steps:

1. Press the M key to enter the main menu.

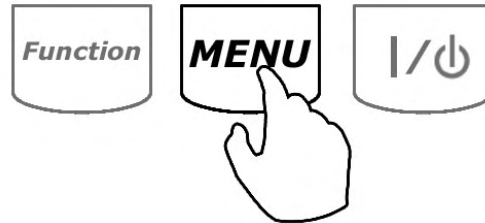

2. When command “DENSITY” is displayed, press the T key.

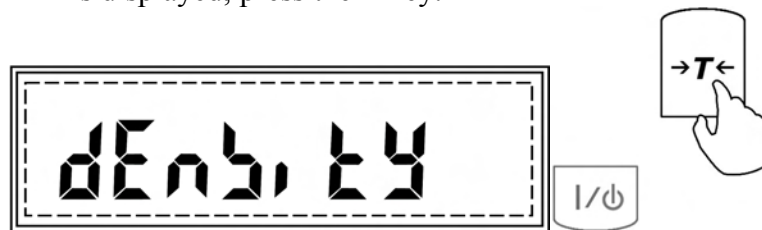

3. Commands “DEN ON” and “DEN OFF” will be displayed sequentially.

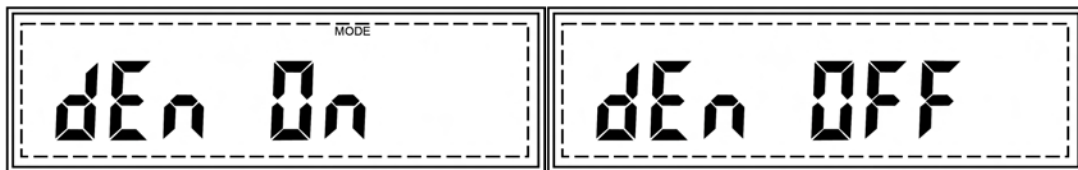

4. To proceed with density calculation, press the T key when “DEN ON” is displayed.

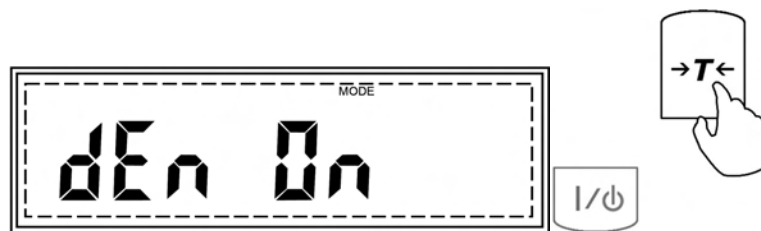

5. Press the T key when command SOLID is displayed.

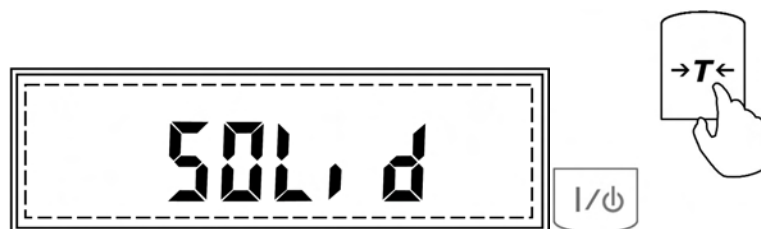

6. Commands H2O (distilled water), ETHANOL, and OTHER will scroll sequentially. Select the liquid that will be used in this density calculation by pressing the T key when the corresponding command is displayed.

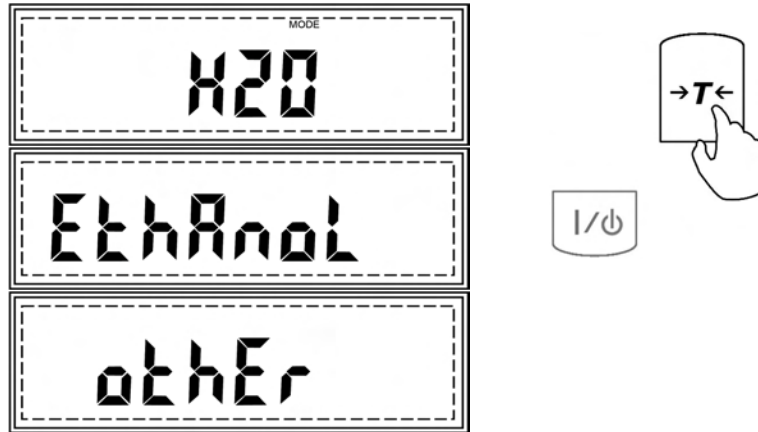

**NOTE:**

If you are using a liquid other than H2O (distilled water) or ETHANOL, select OTHER by pressing the T key and key in the density value of the liquid that will be used. To key in the density value of the liquid, use the following keys: the C key to increment a digit, the T key to accept and go to the next digit, and MENU to accept the setting.

7. Once the liquid for your density calculation has been selected, command t °C will be displayed indicating to key in the temperature of the liquid. Key in the temperature of the liquid with a precision to 0.5 (half a degree Celsius). To key in the temperature of the liquid, use the following keys: the C key to increment a digit, the T key to accept and go to the next digit, the P key to insert a decimal, and MENU to accept the setting.

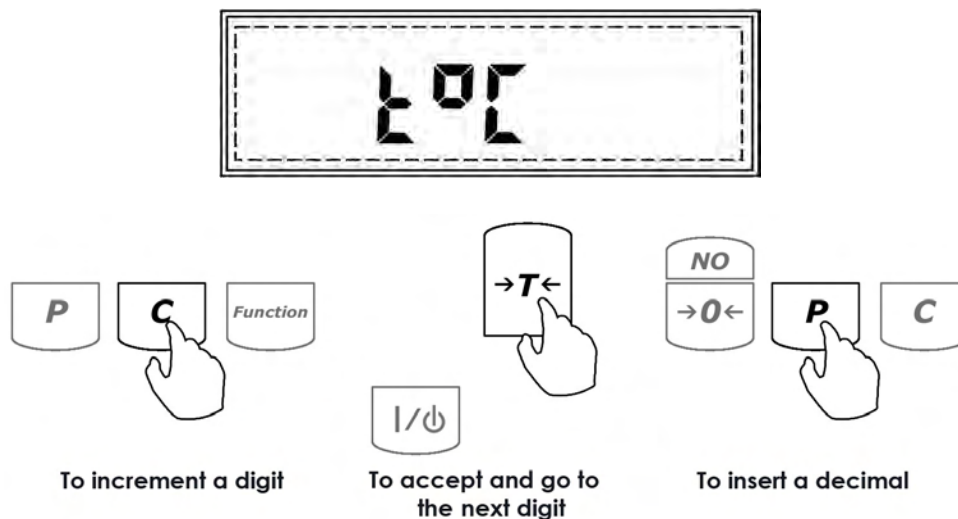

8. Once the temperature has been entered and accepted, command “PRESS TARE” will be displayed indicating to tare the scale.



9. Once the scale has been tared, place the solid object on the upper pan of the density kit to perform a weighing in the air.

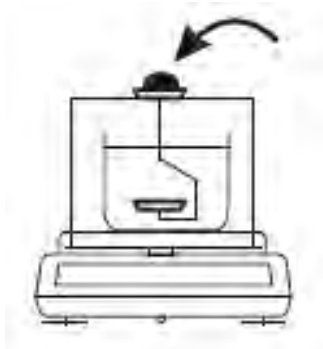

10. Once the weight of the object stabilizes, press the P key. Command “M1” will be displayed indicating that the weight of the object in air has been stored in the formula.

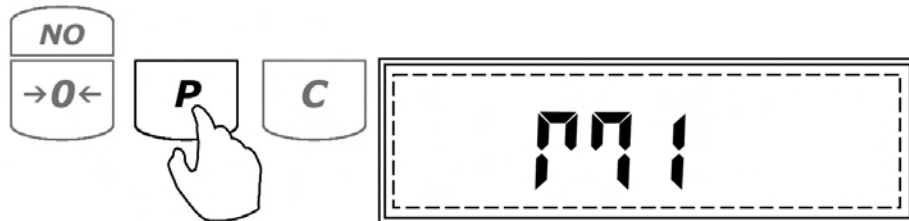

11. Remove the object from the upper pan of the density kit and place it on the lower pan of the density kit to perform a weighing in liquid.

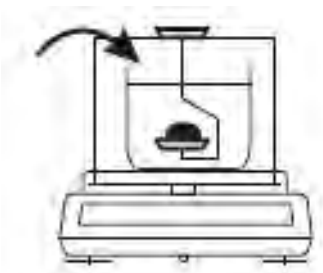

12. Once the weight of the object stabilizes, press the P key. Command “M2” followed by command “RESULT” will be displayed, indicating that the weight of the solid in the liquid has been stored in the formula and the density calculation has been performed.



13. The density of the object will be displayed and locked on the LCD.



14. If a printer or a computer is connected to the scale, you may print detailed results of the performed density calculation by pressing the P key.

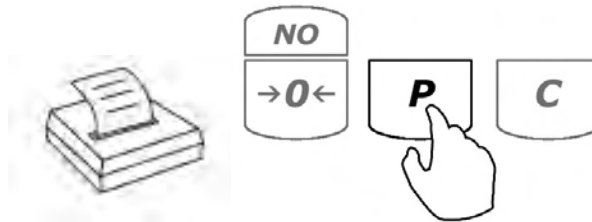

### 14.1.2.Liquid

To calculate the density of a liquid, follow these steps.

1. Press the M key to enter the main menu.

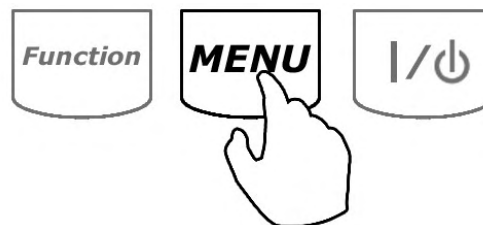

- When command “DENSITY” is displayed, press the T key.

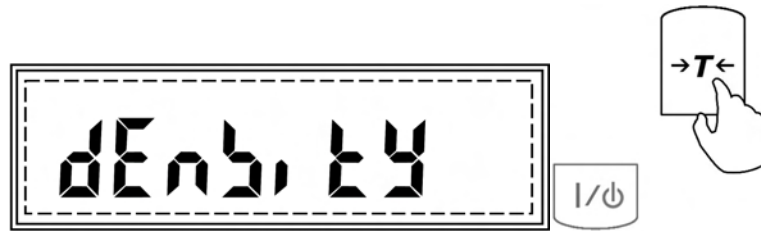

- Command “DEN ON” and “DEN OFF” will be displayed sequentially.

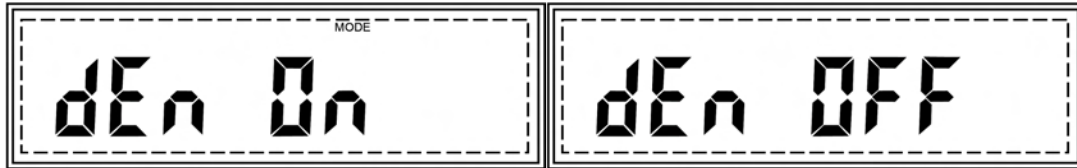

- To proceed with the density calculation, press the T key when “DEN ON” is displayed.

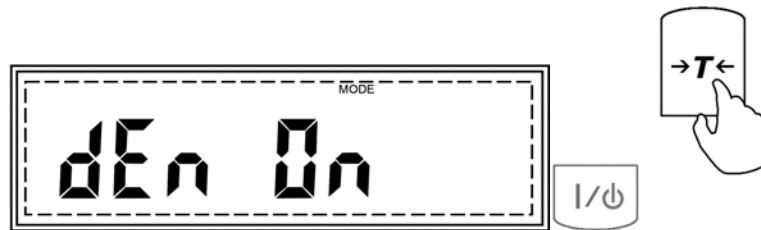

- Press the T key when command “LIQUID” is displayed.

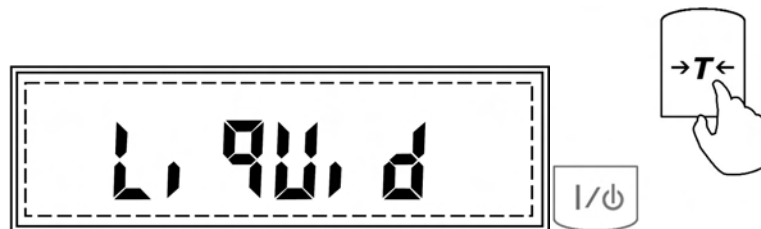

- Once LIQUID is selected, command “PLUNGER” will be displayed, indicating to enter the volume of the plunger used in the density kit, which can be found on the plunger hook included with the density kit.





7. To key in the volume of the plunger, use the following keys: the C key to increment a digit, the T key to accept and go to the next digit, the P key to insert a decimal, and MENU to accept the setting.



8. Once the volume of the plunger has been entered, command “PRESS TARE” will be displayed indicating to tare the scale.



9. Once the scale has been tared, hang the plunger on the wire support frame of the density apparatus.

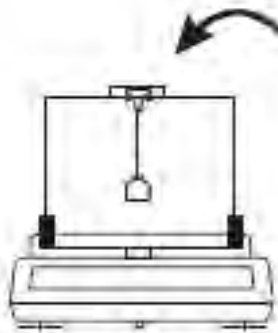

10. The weight of the plunger will be displayed. Once the weight is stable, press the P key. Command “M1” will be displayed, indicating that the weight of the plunger has been stored in the formula.

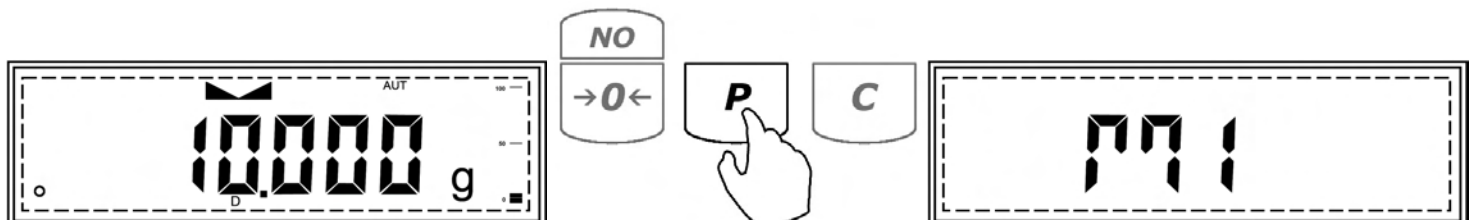

11. Submerge the plunger, by placing the beaker with the liquid on the base of the density apparatus.

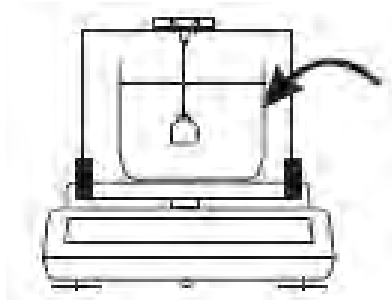

12. As the plunger displaces the liquid in which it is submerged, the weight will decrease. Once the new weight stabilizes, press the P key.

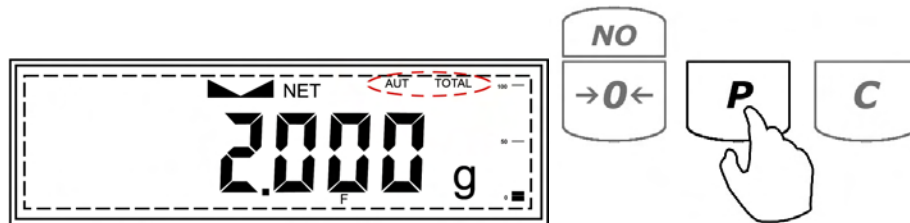

13. Command “M2” followed by command “RESULT” will be displayed indicating that the new weight of the plunger has been stored in the formula and the density calculation has been performed.

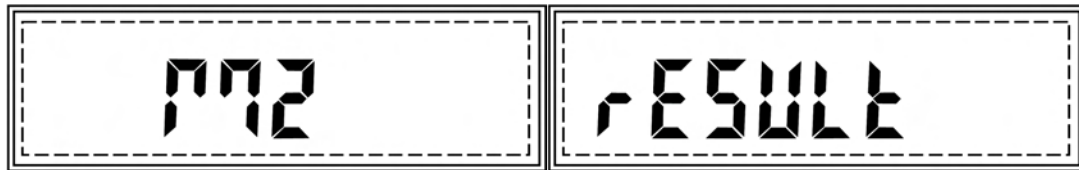

14. The density of the liquid will be displayed and locked on the LCD.



15. If a printer or a computer is connected to the scale, you may print detailed results of the performed density calculation by pressing the P key.

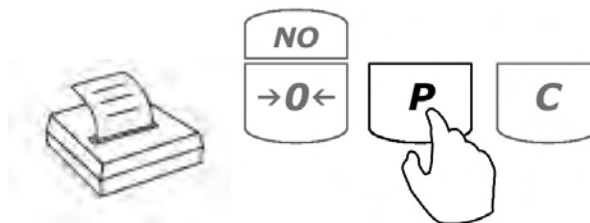

## Chapter 15.

# PRINTING AND RS232 COMMUNICATION PORT CONFIGURATION

After a weighing transaction is completed, a result data receipt can be printed. To initiate printing, wait for the weighing result to stabilize and press the P key.

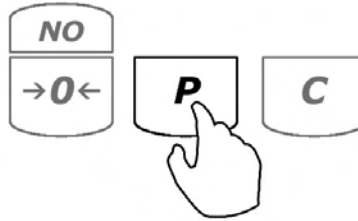

### 15.1.1.Torbil Printer Configuration (RXP-4)

The printing function is used to print data via the RS232 port. Data may be printed via the printer or sent to a PC via the Torbal Communication Software.

To connect the AGCN Scale to a Torbal (RXP-4) printer, use the following settings:

Scale settings:

Baud rate: 9600

Parity: none

Data bits: 8

Printer settings (follow the steps detailed in the RXP-4 instruction manual):

Baud rate: 9600

Data: 8 bits

Parity: none/ignore

Column printing: 40

SW-1	SW-2	SW-3	SW-4	SW-5	SW-6	SW-7	SW-8
OFF	OFF	ON	ON	ON	OFF	OFF	OFF

### RS232 Communication Port Configuration



### 15.1.2.Baud

1. Enter the main menu by pressing the MENU key.

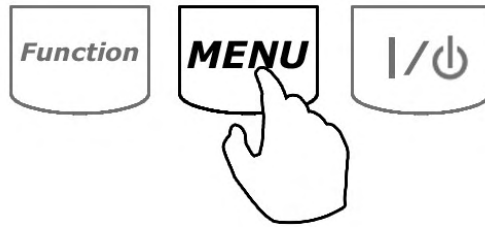

2. When “RS-232” is displayed, press the T key.

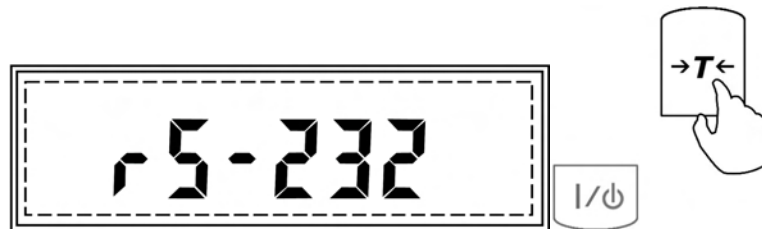

3. Commands “BAUD”, “BITS”, and “PARITY” will begin to scroll sequentially.



4. Press the T key when “BAUD” is displayed.

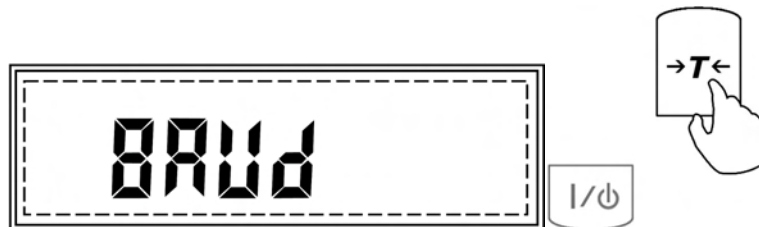

- The scale will begin to display available baud rates: 1200, 2400, 4800, 9600, 19200, 38400, 57600, 115200. To make a selection, press the T key when the desired setting is displayed.

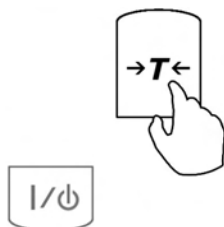
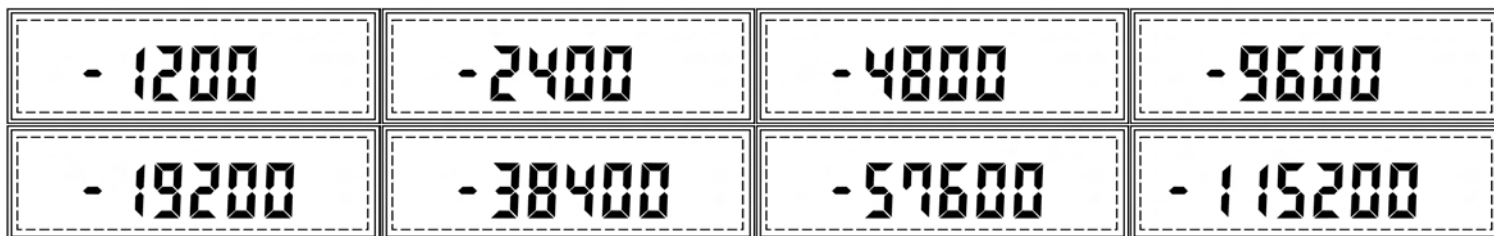

### 15.1.3.Parity

- Enter the main menu by pressing the MENU key.

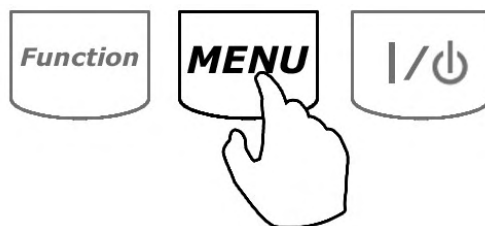

- When “RS-232” is displayed, press the T key.

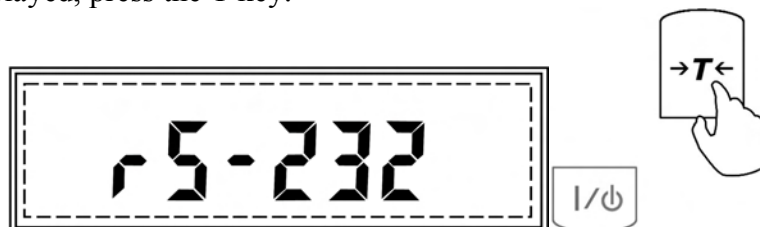

- Commands “BAUD”, “BITS”, and “PARITY” will begin to scroll sequentially.



4. Press the T key when “PARITY” is displayed.

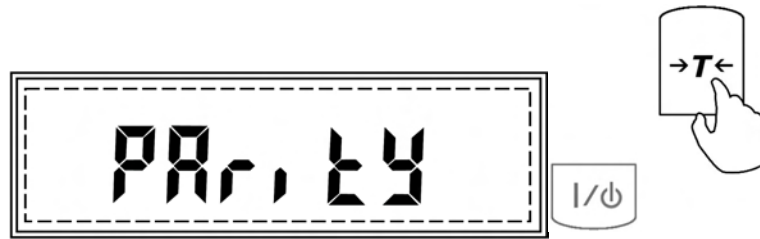

5. The scale will display available “PARITY” settings: “NONE”, “ODD”, and “EVEN”.



6. To make a selection, press the T key when the desired setting is displayed.

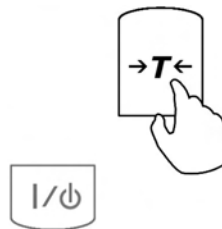

### 15.1.4.Bits

1. Enter the main menu by pressing the MENU key.

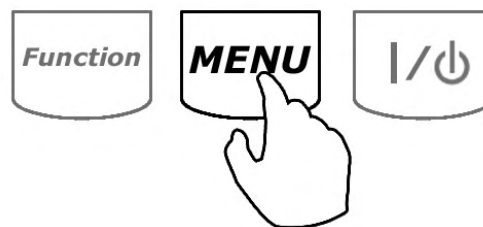

2. When “RS-232” is displayed, press the T key.

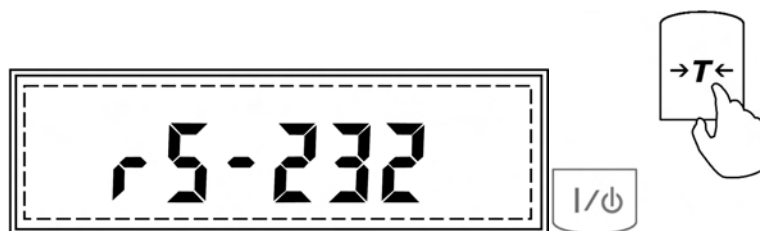

3. Commands “BAUD”, “BITS”, and “PARITY” will begin to scroll sequentially.



4. Press the T key when “BITS” is displayed.

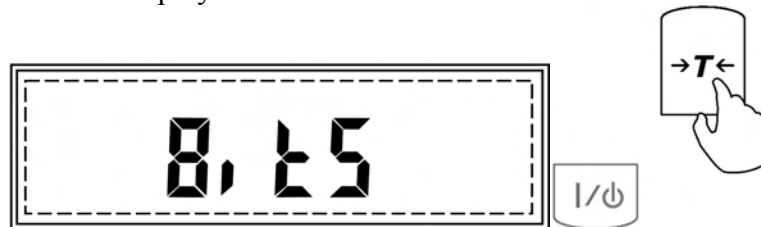

5. The scale will display available BITS settings: “7-BIT”, “8-BIT”.

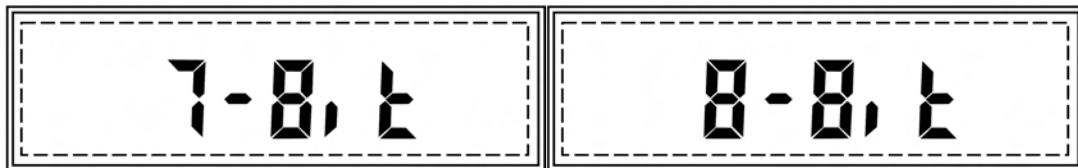

6. To make a selection, press the T key when the desired setting is displayed.

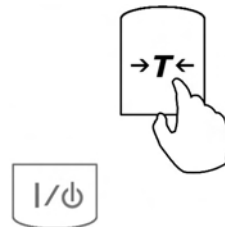

## Chapter 16.

# DATE AND TIME

To set the current time and date, follow these steps.

1. Enter the main menu by pressing the MENU key.

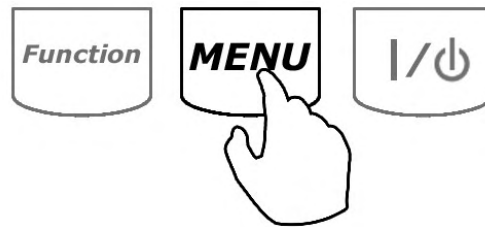

2. When command “DATE” is displayed, press the T key.



3. Commands “TIME” and “DATE” will scroll sequentially.

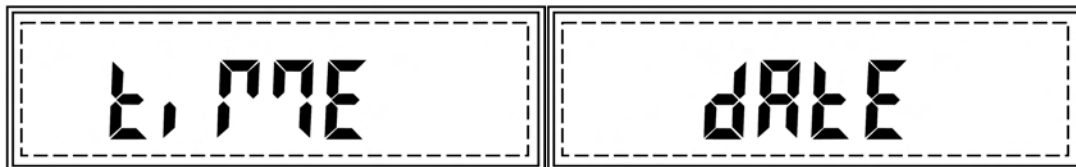

### 16.1.1.Time

1. To set the current time, press the T key when “TIME” is displayed.





- The current time setting and the command “OUT” will scroll sequentially. To adjust the time, press T when the time is displayed. To exit, press the T key when command “OUT” is displayed.
- After the T key is pressed, when the current time is displayed, command “HOUR” will be displayed followed by a dashed line.

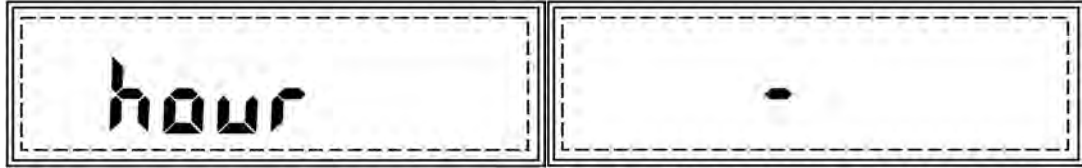

- Use the following keys to enter the current hour setting: the C key to increment a digit, the T key to accept and go to the next digit, and MENU to accept the hour setting.



- Once the hour is set, command “MINUTE” will be displayed followed by a dashed line.

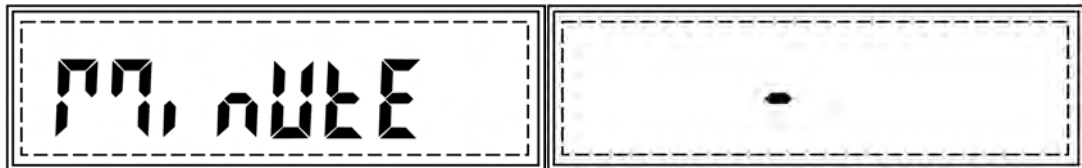

- Use the following keys to enter the current minute setting: the C key to increment a digit, the T key to accept and go to the next digit, and MENU to accept the minute setting.



- Once the minute setting is saved, the scale will save the current time setting and return to the date and time menu.

### 16.1.2.Date

1. To set the date, press T when “DATE” is displayed.

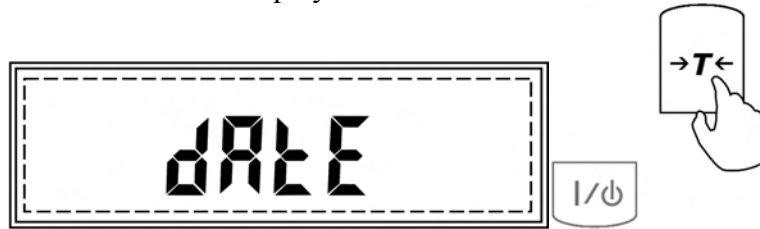

2. The current date setting and the command “OUT” will scroll sequentially. To set a new date, press T when the date is displayed. To exit, press T when command “OUT” is displayed.
3. After T is pressed, when the current date is displayed, command “YEAR” will be displayed followed by a dashed line.

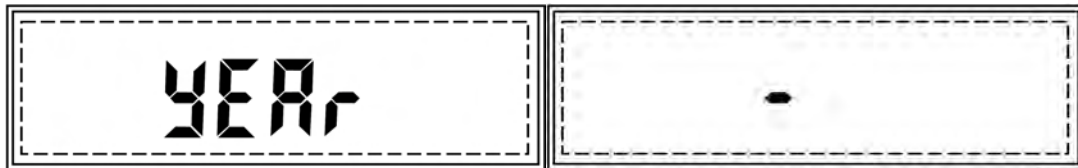

4. Use the following keys to enter the current year setting: the C key to increment a digit, the T key to accept and go to the next digit, and MENU to accept the year setting. Use a four-digit year configuration (i.e., 2007).



5. Once the year is set, command “MONTH” will be displayed followed by a dashed line.

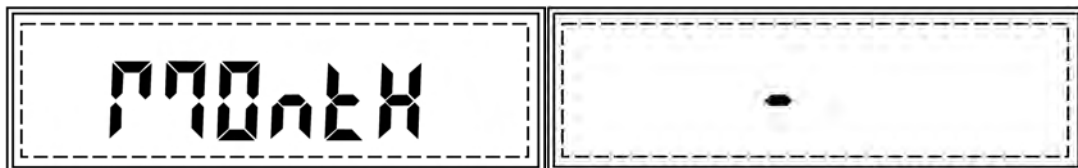

6. Use the following keys to enter the current month setting: the C key to increment a digit, the T key to accept and go to the next digit, and MENU to accept the month setting.



7. Once the month setting is set, command “DAY” will be displayed followed by a dashed line.

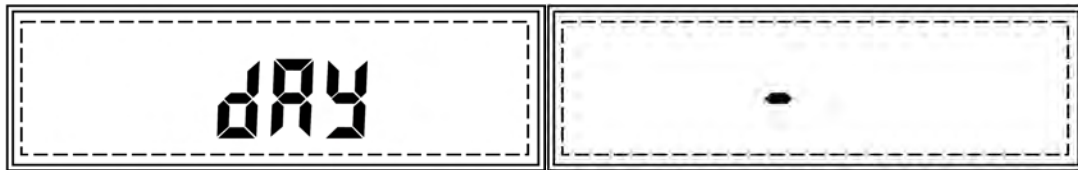

8. Use the following keys to enter the current day setting: the C key to increment a digit, the T key to accept and go to the next digit, and MENU to accept the day setting.



9. Once the day setting is saved, the scale will save the current date setting and return to the date and time menu.

10. To exit the date and time menu, press the T key when command “OUT” is displayed.

## Chapter 17.

# MENU CUSTOMIZATION

The main menu can be customized to deactivate commands and functions that are not in use (i.e., if the RS232 configuration function is seldom used, you may wish to remove it from the main menu to speed up access to other functions used more often). To customize the main menu, follow these steps:

1. Press the main MENU key to enter the main menu.

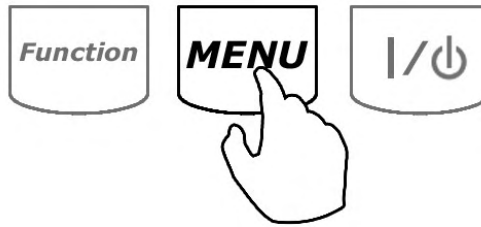

2. Press the T key when the command "ACTIV" is displayed.

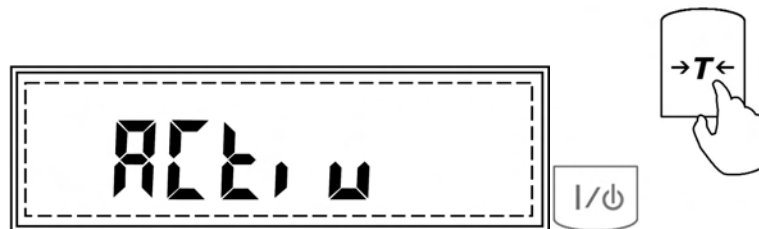

3. All main menu functions and commands will begin to scroll. Enabled functions will have the symbol "o" displayed in the lower left corner of the display.
4. To deactivate a function, press the T key when it appears on the display.

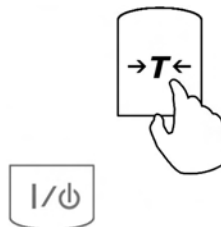

5. Commands "ON" and "OFF" will begin to scroll sequentially. To deactivate the function from the main menu, press the T key when "OFF" is displayed. To activate the function for the main menu, press the T key when "ON" is displayed.





## Chapter 18.

**COMMON ERRORS AND TROUBLESHOOTING**

<b>Error or Indicator</b>	<b>Cause</b>	<b>Explanation / Solution</b>
----	Below zero	Re-zero the scale by pressing the → 0← key.
--	Taring is not allowed	Place a weight on the pan before taking a tare.
- -	Re-zeroing is not allowed	Remove weight from pan and clear stored tare values
L	Pan error	Make sure that pan is properly seated on the pan support
.H	Exceeded capacity	The scale has exceeded its weighing capacity. Reduce the weight.
Err – b	Pan not cleared on power-up	The pan was not empty while the scale was initiating at startup. Clear the pan and restart the scale.
<i>Sapl LO</i> (Parts Counting)	Average piece weight is too low	The average piece weight is lower than 3e. Be sure that individual piece weight is greater than 3e.
<i>Sapl LO</i> (Percent Weighing)	Sample Reference weight is too low	The sample reference weight is lower than 100d. Increase the sample weight.
The scale will not turn on	Possible power failure	Check the power AC adapter connection
Weighing results are not accurate	Inaccurate calibration	Calibrate the scale
Weighing result will not stabilize	Irregular environment	Eliminate drafts or vibrations



## Chapter 19.

# MAINTENANCE

### Cleaning and maintaining your AGCN Precision Scale:

- Before cleaning the scale always unplug the A/C adapter from the electrical outlet.
- Use a soft, slightly damp cloth to clean the exterior housing of your scale,.
- Wipe the scale gently. Do not allow any liquid to enter into the scale.
- Do not apply extensive pressure to the LCD display.
- Do not use chemicals or benzene when cleaning the surface. Corrosive chemicals may damage the finish.
- Alcohol may be used only to clean the scale's stainless steel pan or the draft ring.

## Chapter 20.

# ACCESSORIES

Description	Part No.
Draft Shield Cover	AGC9120
RXP-4 Thermal Printer	AGC9130
RS232 PC Cable	AGC9140

## Chapter 21.

# REPLACEMENT PARTS

Description	Part No.
A/C Adapter	AGC9150
Pan Assembly	AGC9160
RS232 Printer Cable	AGC9170



## Chapter 22.

# LIMITED WARRANTY

### PURCHASER'S 24-MONTH WARRANTY

Warranty is valid only if the attached warranty registration card is completed and returned within 30 days.

This product is a precision device made to exacting standards of scientific accuracy. It is guaranteed to have been adjusted and inspected for proper workmanship and performance, and certified for its currently advertised specifications before shipment.

Fulcrum Products are warranted against defects in material and workmanship under normal use and service. This warranty is extended only to the first purchaser. This limited warranty will not apply if, upon inspection, it is found that the product was tampered with, misused, overloaded, or abused. mishandled, placed in an improper environment, improperly installed or adjusted, used for a purpose other than that for which it was designed, or repaired by unauthorized personnel.

Fulcrum's liability under this warranty is limited to furnishing labor and parts necessary to remedy the defect covered by this warranty and restore the product to normal operating condition. Purchasers may be charged a minimum repair fee for in-warranty products returned for repair if those products are determined to be problemfree. To make a claim under this limited warranty, obtain an RMA number from Fulcrum and return the product, carefully packed in its original packaging, shipping prepaid, with the RMA number written on the return package.