

CUTSHEET

Front View

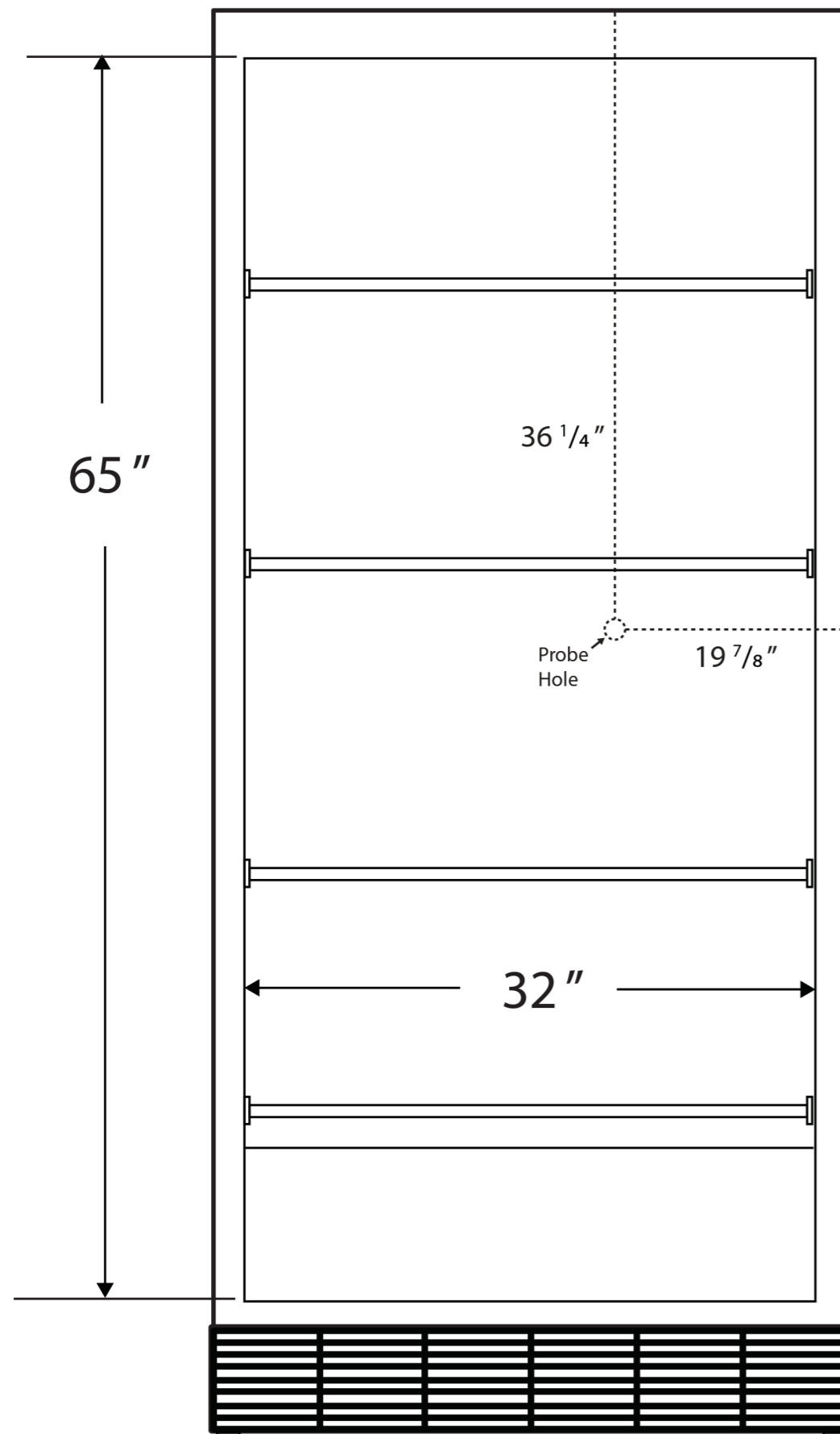

Side View

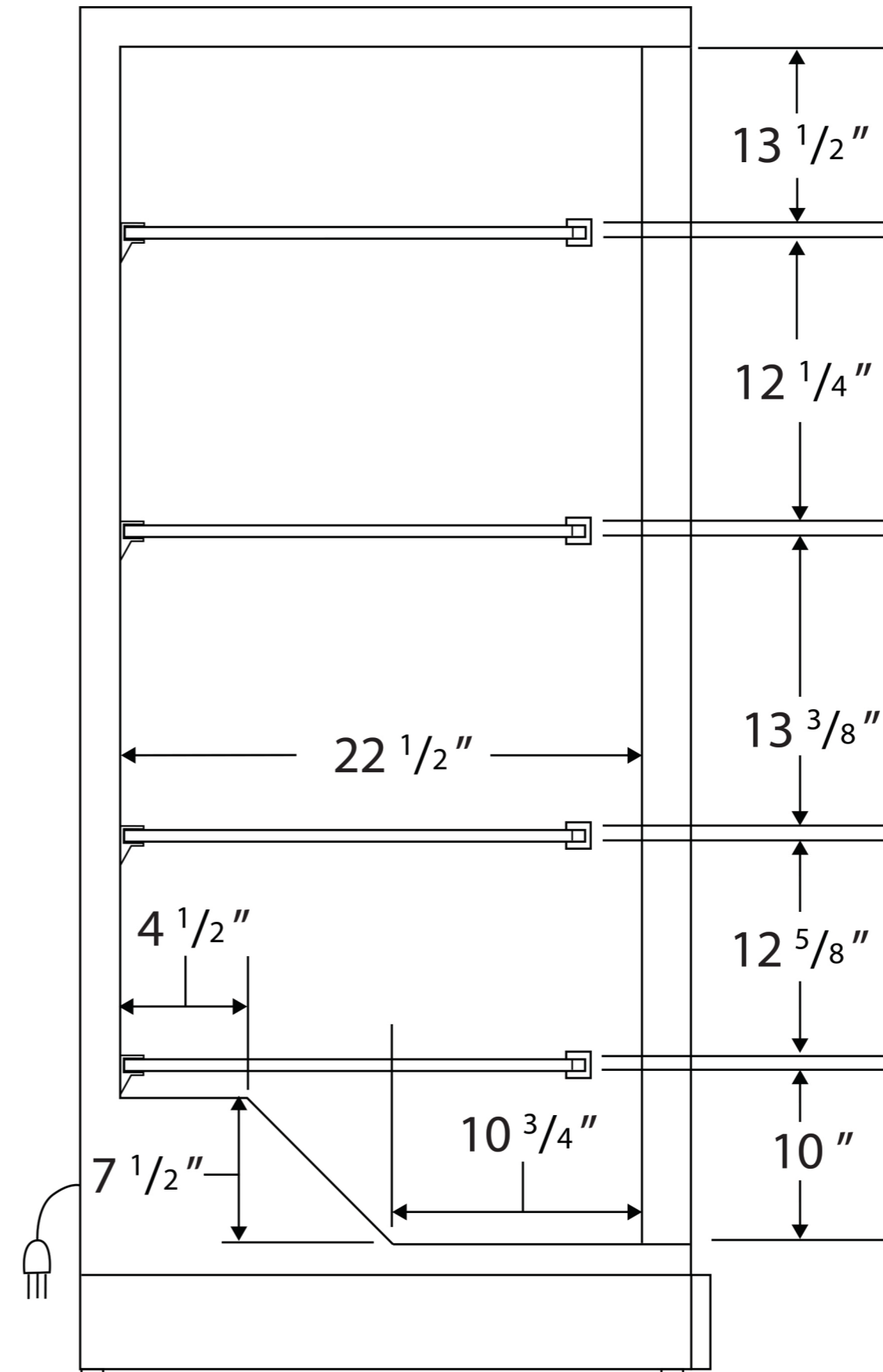

115VAC/60Hz/1PH
NEMA-5-15P

Cu. Ft	Defrost	Door	Int Door	Shelves	Interior Dim.			Refrigerant	H.P.	Amps	Weight
					W"	D"	H"				
30	Manual	1 Solid	0	4 Fixed	32	22 1/2	65	R404a	1/3	6	305 lbs.

Note: Interior dimensions are estimates and subject to change without notice