

Front View

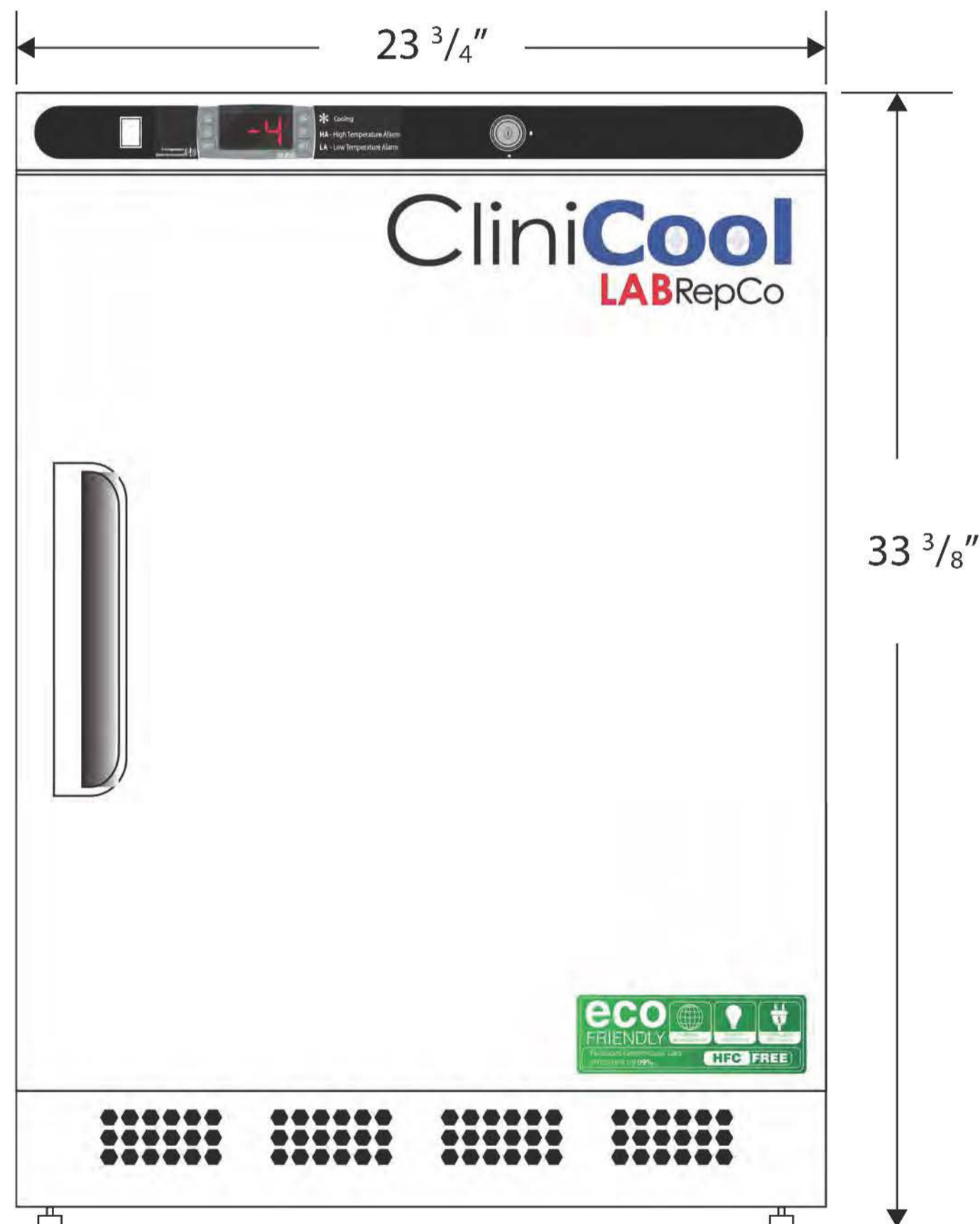

Side View

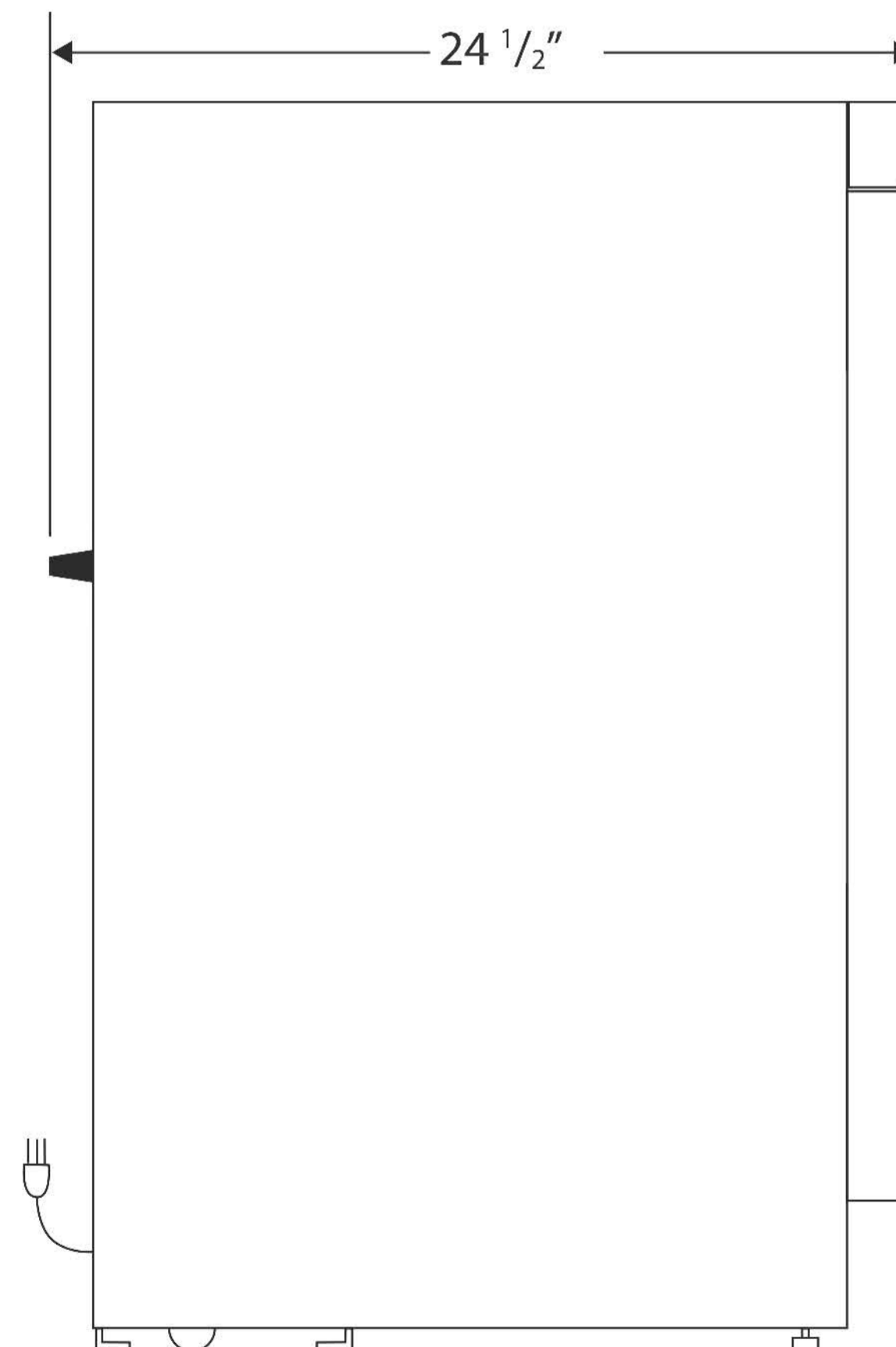

Top View

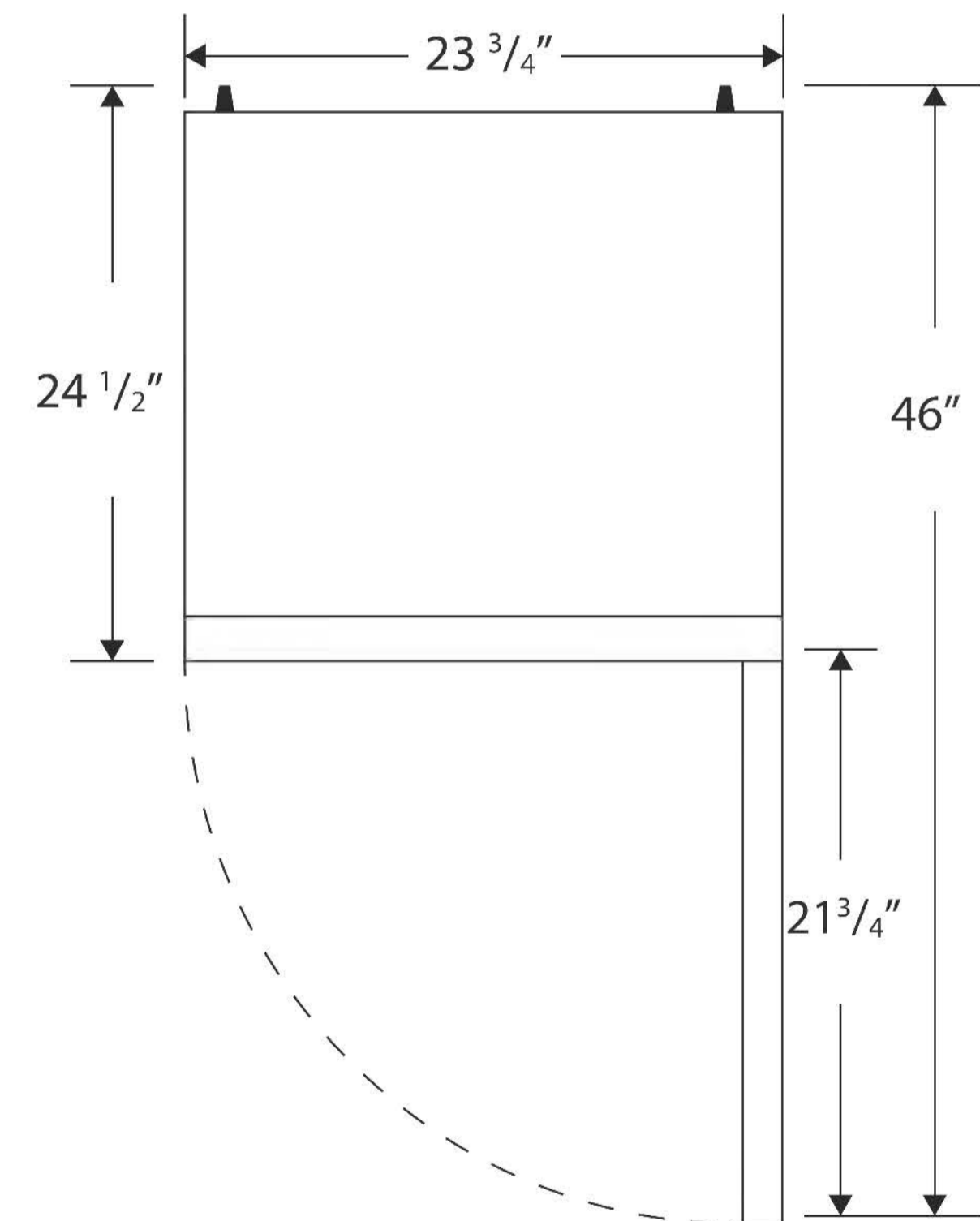

115VAC/60Hz/1PH  
 NEMA-5-15P

Cu. Ft	Defrost	Door	Int Door	Shelves	W"	D"	H"	Refrigerant	H.P.	Amps	Weight
4.2	Manual	1 Solid	0	2 Fixed	23 3/4	24 1/2	33 3/8	R600a	1/8	1.5	100 lbs.