

Front View

Side View

Top View

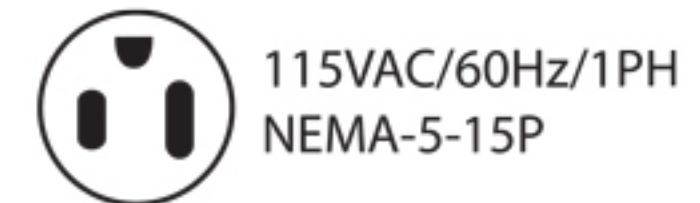
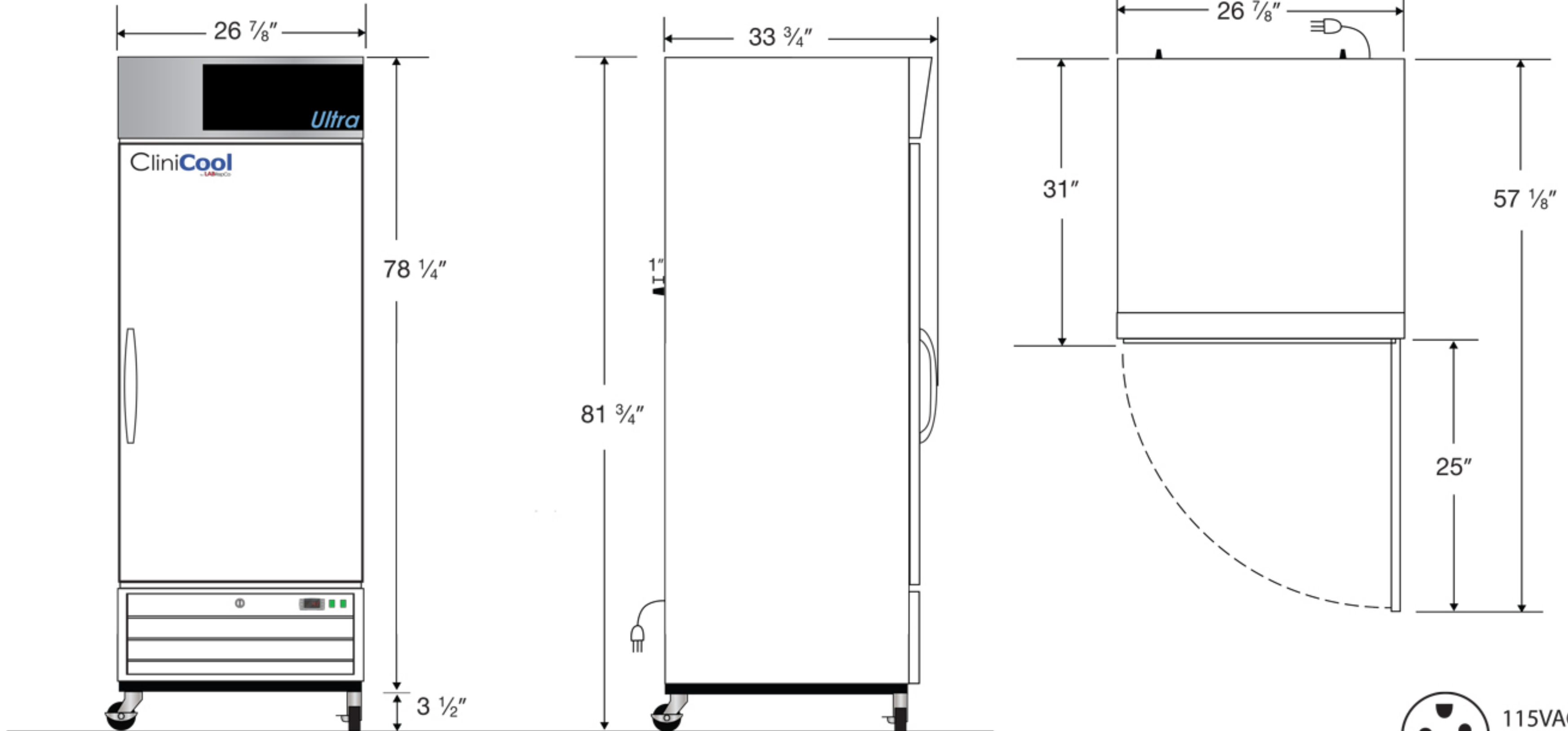

Cu. Ft	Defrost	Door	Int Door	Shelves	W"	D"	H"	Refrigerant	H.P.	Amps	Weight
23	Cycle	1 Solid	0	4 Adj	$26 \frac{7}{8}$	$34 \frac{3}{4}$	$81 \frac{3}{4}$	R290	$\frac{1}{5}$	3	210 lbs.