

PHCbi

Operating Instructions

CO₂ Incubator

MCO-170ACL



For Research Use Only.

This product is for research use only.

Not for clinical diagnosis or treatment of humans or animals.

Please read the operating instructions carefully before using this product, and keep the operating instructions for future use.

See page 78 for all model numbers.

CONTENTS

INTRODUCTION	4
PRECAUTIONS FOR SAFE OPERATION.....	5
SYMBOLS ON INCUBATOR	11
ENVIRONMENTAL CONDITIONS.....	11
INCUBATOR COMPONENTS	
Unit	12
Control panel	14
Remote alarm terminal.....	15
INSTALLATION	
Installation site.....	16
Installation	17
Connecting a CO ₂ gas cylinder	19
BEFORE COMMENCING OPERATION	
Initial cleaning method.....	20
Removing inner attachments	21
Installing inner attachments.....	23
Filling the humidifying pan.....	24
FOR OPTIMAL CULTIVATION	
Precautions for cultures.....	25
Preventing contamination.....	26
CORRECT OPERATION	27
HOME SCREEN	28
MENU SCREEN	30
BASIC PARAMETERS	
Setting temperature.....	32
Setting CO ₂ gas	33
Setting CO ₂ density	34
Setting high limit temperature alarm	35
OPERATION/ALARM LOG	
Displaying operation log	36
Exporting operation log.....	39
Setting log interval.....	41
Setting Unique ID	42
Displaying alarm log	43
Exporting alarm log	44
KEY LOCK FUNCTION	
Setting key lock.....	46
Removing key lock.....	47

CONTENTS

ALARM PARAMETERS	
Setting automatic set temperature alarm.....	48
Setting automatic set temperature alarm delay.....	49
Setting automatic set CO ₂ density alarm.....	50
Setting automatic set CO ₂ density alarm delay.....	51
Setting door alarm delay.....	52
Setting ring back delay.....	53
Setting remote alarm.....	54
UV LAMP (OPTION)	
Using UV lamp.....	55
Setting UV lamp ON period.....	56
UV lamp life indication.....	57
Setting UV timer extension.....	58
Lighting the UV lamp for 24 hours.....	59
GAS AUTO-CHANGER (OPTION)	
Connecting CO ₂ gas cylinders.....	60
Automatic CO ₂ gas supply line changeover.....	60
Manual CO ₂ gas supply line A/B changeover.....	62
OTHER PARAMETERS	
Setting date display (format).....	63
Setting date.....	64
Setting time.....	65
Setting keypad click.....	66
ALARMS, SAFETY, AND SELF-DIAGNOSIS.....	67
TROUBLESHOOTING.....	70
DISPOSAL OF UNIT.....	72
SPECIFICATIONS.....	77
PERFORMANCE.....	78
SAFETY CHECK SHEET.....	79

INTRODUCTION

- Read the operating instructions carefully before using the product and follow the instructions for safe operation.
- PHC Corporation takes no responsibility for safety if the product is not used as intended or is used with any procedures other than those given in the operating instructions.
- Keep the operating instructions in a suitable place so that they can be referred to as necessary.
- The operating instructions are subject to change without notice for improvement of performance or function.
- Contact our sales representative or agent if any page of the operating instructions is lost or the page order is incorrect, or if the instructions are unclear or inaccurate.
- No part of the operating instructions may be reproduced in any form without the express written permission of PHC Corporation.

IMPORTANT NOTICE

PHC Corporation guarantees this product under certain warranty conditions. However, please note that PHC Corporation shall not be responsible for any loss or damage to the contents of the product.

<Intended Use>

This equipment is designed for cell and tissue culture for laboratory use.

PRECAUTIONS FOR SAFE OPERATION

It is imperative that the user complies with the operating instructions as they contain important safety advice.

Items and procedures are described so that this unit can be used correctly and safely. Following these precautions will prevent possible injury to the user and any other person.

Precautions are illustrated in the following way:



WARNING

Warning indicates a potentially hazardous situation which, if not avoided, could result in serious injury or death.

CAUTION

Failure to observe CAUTION signs could result in injury to personnel and damage to the unit and associated property.

Symbols have the following meaning;

-  This symbol means caution.
-  This symbol means an action is prohibited.
-  This symbol means an instruction must be followed.

WARNING

As with any equipment that uses CO₂ gas, there is a likelihood of oxygen depletion in the vicinity of the equipment. It is important that you assess the work site to ensure there is suitable and sufficient ventilation. If restricted ventilation is suspected, then other methods of ensuring a safe environment must be considered. These may include atmosphere monitoring and warning devices.

Be sure to keep the operating instructions in a place that is accessible to users of this unit.

PRECAUTIONS FOR SAFE OPERATION

USA Only (Model with a lamp): This product has a lamp that contains mercury. Disposal may be regulated in your community due to environmental considerations. For disposal or information, please visit PHC website: <https://www.phchd.com>.

Contains mercury / Contenu avec mercure

For more information on safe handling procedures, the measures to be taken in case of accidental breakage and safe disposal options visit:

ec.gc.ca/mercure-mercury/.

Dispose of or recycle in accordance with applicable laws.

Pour plus de renseignements sur les procédures de manutention sécuritaire, les mesures à prendre en cas de bris accidentel et les options d'élimination sécuritaire visitez:

ec.gc.ca/mercure-mercury/.













Mettez au rebut ou recyclez conformément aux lois applicables.

For the State of California, USA Only:

This product contains a CR Coin Cell Lithium Battery which contains Perchlorate Material – special handling may apply. See www.dtsc.ca.gov/hazardouswaste/perchlorate.















PRECAUTIONS FOR SAFE OPERATION

WARNING

-  **Do not use the unit outdoors.** Exposure to rain may cause leakage and/or electric shock.
-  **Only qualified engineers or service personnel should install the unit.** The installation by unqualified personnel may cause electric shock or fire.
-  **Install the unit in a location capable of bearing the total combined weight (product + optional accessories + stored items). After installing the unit, be absolutely sure to take precautions to prevent the unit from falling over.** If the unit is installed in a location which is not strong enough or if the proper precautions are not taken, the unit may fall over and cause injuries.
-  **Do not install the unit where there are high levels of moisture or where it may be splashed with water.** Installing the unit where there are high levels of moisture or where it may be splashed with water may cause the insulation to deteriorate and give rise to leakage and/or electric shock.
-  **Do not install the unit in a location where flammable or volatile substances are present.** Installing the unit in a location where flammable or volatile substances are present may cause explosions and/or a fire.
-  **Do not install the unit in a location where corrosive gases such as acids are present.** Installing the unit in a location where corrosive substances are present may cause electric components to corrode, leading to leakage and/or electric shock due to the deterioration of insulation resulting from corroded electrical components.
-  **Do not place this unit in a location where it is difficult to disconnect the power supply plug.** Failure to disconnect the power supply plug may cause fire in the event of a problem or malfunction.
-  **Be absolutely sure to earth (ground) the unit in order to prevent electric shock.** Failure to earth the product may give rise to electric shock. If necessary, ask a qualified contractor to do this work.
-  **Do not connect the earth wire to a gas pipe, water pipe, or lightning rod when earthing the unit.** Earthing the unit improperly may give rise to electric shock.
-  **Connect the unit to a power source as indicated on the rating label attached to the unit.** Use of any other voltage or frequency other than that on the rating label may cause fire or electric shock.
-  **Never store volatile or flammable substances in this unit except in a sealed container.** Such substances may cause explosion or fire if they leak.
-  **Never insert metal objects such as pins and wires into any vent, gap or outlet on the unit.** This may cause electric shock or injury by accidental contact with moving parts.
-  **When handling harmful samples (for example, those which consist of toxic, pathogenic, or radioactive substances), install the unit inside a designated isolation facility.** If the unit is installed in a location which is not an isolation facility, there may be detrimental effects on both people and the natural environment.









PRECAUTIONS FOR SAFE OPERATION

WARNING

-  **Before proceeding with maintenance or checking of the unit, set the power switch to OFF and disconnect the power supply plug.** Performing the work while power is still flowing to the product or while the power-supply plug is still connected may give rise to electric shock and/or injury.
-  **Do not touch any electrical parts (such as power supply plug) or operate switches with a wet hand.** This may cause electric shock.
-  **Wear protective gloves and mask during maintenance.** Touching or inhaling chemicals or aerosols from around the unit may be detrimental to health.
-  **Never splash water directly onto the unit** as this may cause electric shock or short circuit.
-  **Never put containers with liquid on top of the unit** as this may cause electric shock or short circuit if the liquid is spilled.
-  **Never damage the power supply cord or power supply plug (by breaking, adapting, placing near a source of heat, bending with force, twisting, pulling, adding weight, or binding).** A damaged power supply cord or power supply plug may cause electric shock, short circuit, or fire.
-  **Do not use the supplied power cord for other electrical equipment.** Such power supply cord may cause fire or electric shock.
-  **Never disassemble, repair, or modify the unit yourself.** A high-voltage area is located inside the unit. Any work carried out by an unauthorized personnel may result in electric shock. Contact our sales representative or agent for maintenance or repair.
-  **Make sure the power supply plug is pushed fully in.** Faulty insertion of the power supply plug may cause electric shock or fire due to generation of heat. Never use a damaged power supply plug or loose power outlet.
-  **Disconnect the power supply plug if there is anything wrong with the unit.** Continued abnormal operation may cause electric shock or fire.
-  **Grip the power supply plug when disconnecting the power supply cord from the outlet.** Pulling the power supply cord may cause electric shock or short circuit.
-  **Remove dust from the power supply plug periodically.** Dust on the power supply plug may cause insulation failure due to moisture and thus cause a fire. Disconnect the power supply plug and wipe it with a dry cloth.
-  **Disconnect the power supply plug** before moving the unit. Take care not to damage the power supply cord. A damaged cord may cause electric shock or fire.
-  **Disconnect the power supply cord when the unit is not in use for long periods.** Keeping the unit connected may cause electric shock, leakage, or fire due to the deterioration of insulation.











PRECAUTIONS FOR SAFE OPERATION

WARNING

-  If the unit is to be stored unused in an unsupervised area for a long period, **ensure that children do not have access and that doors cannot be closed completely.**
-  **Ask a qualified contractor to carry out disassembly and disposal of the unit.** Leaving the unit in a location that can be accessed by third parties may result in unexpected accidents (e.g. the unit may be used for unintended purposes).
-  **Do not leave the plastic bags used for packing in a place where they can be reached by small children** as this may result in unexpected accidents such as suffocation.
-  **Always use the removal power supply cord that is provided.** Other power supply cord may cause electric shock or fire.
-  When using CO₂ gas for control, **make sure that there is adequate ventilation.** Using CO₂ gas in a small room without adequate ventilation may cause gas poisoning or oxygen deprivation. In addition, when opening the incubator doors, do not directly inhale the air in the chamber.
-  When connecting a gas cylinder to the incubator, **confirm the gas type. Confirm that the connections are secure and that no gas will leak. Be sure to use the specified pressure.** Using an incorrect gas or pressure may result in explosion or fire, or in gas poisoning or oxygen deprivation due to gas leak.
-  **Install the incubator in a location with adequate ventilation.** If adequate ventilation cannot be provided, then install an alarm system using CO₂ and O₂ densitometers.
-  **Do not look directly at UV light.** UV light is harmful to the eyes.
-  **The CO₂ incubator must be dismantled and disposed of by qualified personnel only.** If the CO₂ incubator is left where outsiders enter, it may result unexpected accident (for example, children to become locked inside).





PRECAUTIONS FOR SAFE OPERATION

CAUTION

-  This unit must be plugged into a dedicated circuit protected by branch circuit breaker.
-  Use a dedicated power source as indicated on the rating label attached to the unit. A multiple-tap may cause fire resulting from abnormal heating.
-  **Never store corrosive substances such as acid or alkali** in this unit if the container cannot be sealed. These may cause corrosion of inner components or electric parts.
-  **Check the setting when starting up of operation after power failure or turning off of power switch.** The stored items may be damaged due to the change of setting.
-  **Be careful not to tip over the unit** during movement to prevent damage or injury.
-  **Prepare a safety check sheet** (copy the last page) when you request any repair or maintenance for the safety of service personnel.
-  **Do not climb on top of the incubator or place any object on it.** By doing so you may damage the incubator or knock it over, which may result in injury.
-  **Wear rubber gloves when performing maintenance on the chamber.** Failure to wear gloves may result in cuts or abrasions from sharp edges or corners.
-  **Do not damage the glass or give it a shock.** The Inner door in the CO₂ Incubator are tempered glass, but they can be broken or cause injury if they are used incorrectly.
-  **To ensure the safety of the service engineer, submit a safety check sheet with the required items filled out.** This is provided as the photocopyable “Safety Check Sheet” at the end of these operating instructions

SYMBOLS ON INCUBATOR

The following symbols are attached to the incubator:

	Attached to covers that access high-voltage electrical components to prevent electric shock. Only a qualified engineer or service personnel should be allowed to open these covers.
	Indicates an ultraviolet light (UV) caution.
	Indicates that caution is required. Refer to precautions for safe operation for details.
	Indicates a hot surface.
	Indicates an earthing.
	Indicates "ON" for a power switch.
○	Indicates "OFF" for a power switch.

ENVIRONMENTAL CONDITIONS

This equipment is designed to be safe at least under the following conditions (based on the IEC 61010-1):

- Indoor use;
- Altitude up to 2000 m;
- Temperature 5 °C to 40 °C;
- Maximum relative humidity 80 % for temperature up to 31 °C decreasing linearly to 50 % relative humidity at 40 °C;
- Mains supply voltage fluctuations up to ± 10 % of the nominal voltage;
- Transient overvoltages up to the levels of OVERVOLTAGE CATEGORY II;
- Temporary OVERVOLTAGES occurring on the mains supply;
- Applicable pollution degree of the intended environment (POLLUTION DEGREE 2 in most cases);

INCUBATOR COMPONENTS

Unit

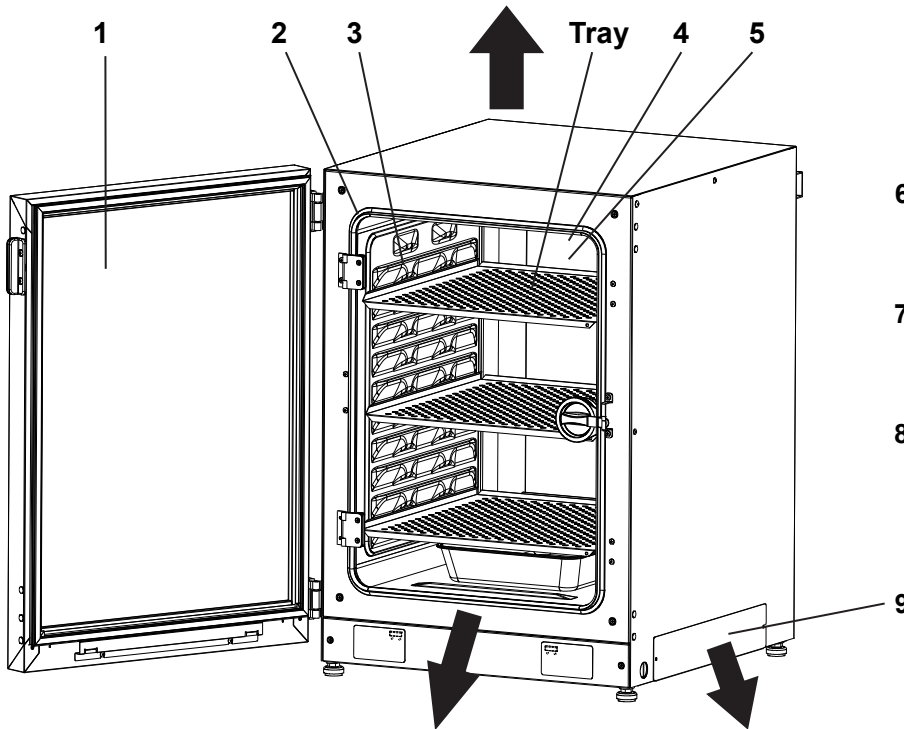
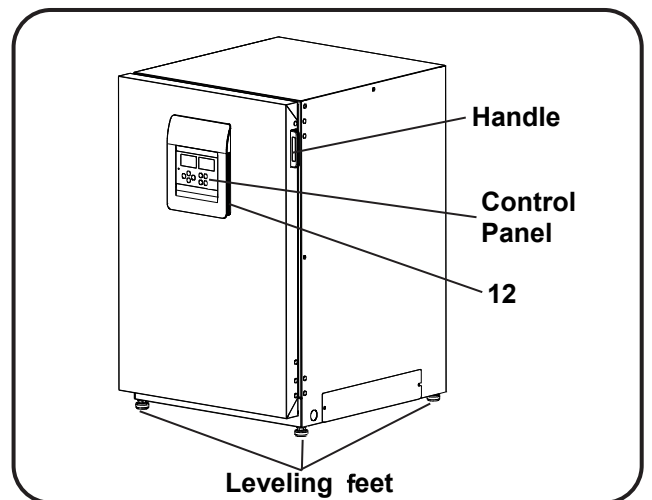
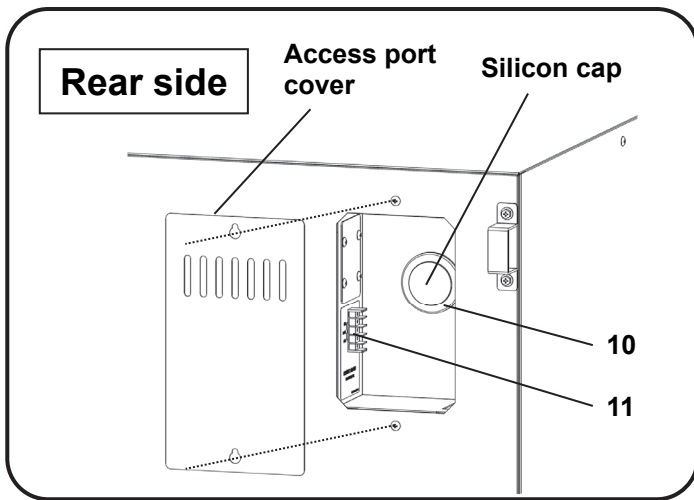

(When some inner attachments are removed)

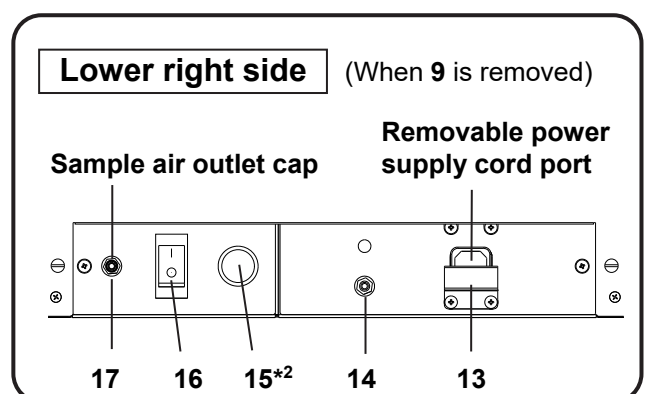
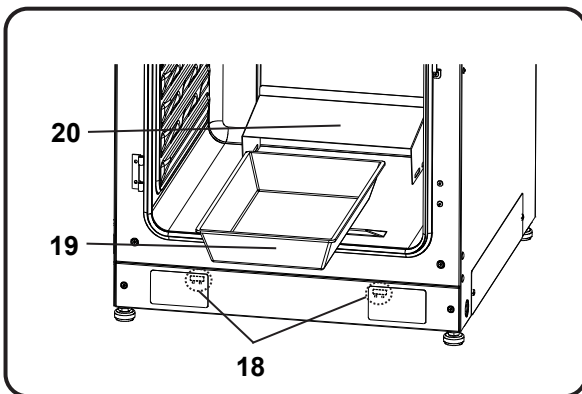
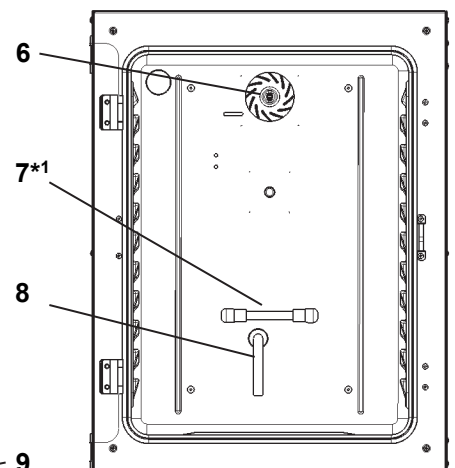

*1: When an optional UV system set MCO-170UVS is installed.

*2: Type FG-7P or FG-7PL.

INCUBATOR COMPONENTS

- 1. Outer door:** The outer door is held to the frame with the magnetic seal. The door heater is installed in the door panel. The door opening is reversible. Contact our sales representative or agent to change the door hinge from left to right or vice versa.
- 2. Inner door:** The inner door is made of tempered glass. Do not subject the glass to excessive impact. Contact our sales representative or agent to change the inner door to optional small doors (MCO-170ID).
- 3. Tray catches:** Insert tray to fit the concave portion on the chamber.
- 4. Fan cover (above the duct):** Serves as the inlet for circulating air. It is removable.
- 5. Duct:** The duct for the path for circulating air. It is removable.
- 6. Fan (inside the duct):** The fan is made from polypropylene resin. It can be disinfected in an autoclave.
- 7. UV lamp*1:** This UV lamp does not generate ozone. For replacement, contact our sales representative or agent.
- 8. Humidity control bar:** Automatically reduces condensation caused by the external environment when the door is frequently opened and closed. The humidity control bar has a bactericidal effect due to its plated surface. However, it is recommended that it is replaced every 5 to 6 years to maintain this effect (The duration of bactericidal effect differs depending on the environment).
- 9. Switch cover:** Prevents shutting down of the unit in case of accidental pressing of the main power switch.
- 10. Access port:** Place the silicon caps on both the outside and inside of the port when the port is not being used.
- 11. Remote alarm terminal:** Sends the alarm to a remote location by connecting to an external alarm unit. Refer to page 15.
- 12. USB port:** Insert USB memory device to export operations and alarms log. Refer to pages 38,39~40,44~45.
- 13. Power supply cord cover plate:** Prevents the power supply cord becoming detached.
- 14. Connecting port A for CO₂ gas pipe:** Refer to page 19 for gas cylinder connection.
Note: When the optional MCO-21GC gas auto-changer is installed, both ports A and B are available. Refer to page 60.
- 15. Glow starter*2:** Starts the glow for the UV lamp.
- 16. Power switch:** This is the main switch for the incubator (ON-"I", OFF-"O"). It also functions as an overcurrent breaker.
- 17. Sample air outlet:** This also functions as an internal gas outlet. In normal use, cover this outlet with the sample air outlet cap.
- 18. Door switch (Beneath the label):** Detects the door opening/closing and stops the fan and electromagnetic valve for CO₂ when the door is open. The UV lamp*1 is also deactivated by the door opening.
- 19. Humidifying pan:** Fill with sterile distilled water.
- 20. Humidifying pan cover:** Prevents UV light entering the chamber.

*1: When an optional UV system set MCO-170UVS is installed.

*2: Type FG-7P or FG-7PL.

INCUBATOR COMPONENTS

Control panel



① OLED (Organic Light Emitting Diode) display

The present chamber temperature/CO₂ density, menu screen or input screen, etc. are displayed.

② POWER/ALARM indicator

In normal operation, the green LED lamp lights up, and during alarm condition, the red LED lamp blinks to indicate alarm.

③ Up/down/left/right key (△▽◀▶)

On the setting screen, pressing this key changes the display.

If the left / right key (◀▶) is displayed at the message of the home screen, you can switch the contents of the message number with the left and right keys.

④ Menu key (MENU/HOME)

On the "home screen": pressing this key leads the menu screen. It is possible to set various setting on the menu screen.

On the screen "other than the home screen": pressing this key leads the home screen.

⑤ Cancel key (CANCEL)

On the setting screen, pressing this key changes into the screen of one level up.

⑥ Buzzer stop key (BUZZER STOP)

The buzzer is silenced by pressing this key when the buzzer sounds.

However, when the ring back is ON, the buzzer will sound again when the set time of ring back passed and the alarm state still continues. Refer to page 53 and 67~69.

Note: It is not possible to silence the buzzer for the high limit temperature alarm.

⑦ Enter key (ENTER)

Press this to select the menu item. Press this key to enter the required value during the setting procedure.

⑧ USB port

Insert a USB memory device to export data logs.

✦ Do not insert anything other than a USB memory device.

INCUBATOR COMPONENTS

Remote alarm terminal

The alarm of this product can be transferred to a remote location by connecting the external alarm unit to the remote alarm terminal. For the behaviour of remote alarm output, refer to pages 67~69.

The terminal of the remote alarm is installed at the rear upper right of the unit (see the figure opposite). The alarm outputs from this terminal. Contact capacity is DC 30 V, 2 A.

Table 1 shows the behaviour of the remote alarm when the BUZZER STOP key is pressed.

Notes:

- The door alarm does not work remotely. Refer to pages 68~69.
- Wiring of the remote alarm should be performed by qualified service personnel.

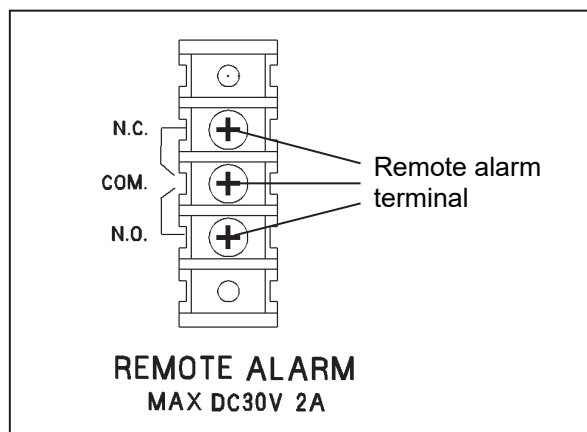

Table 1. Behaviour of remote alarm when pressing BUZZER STOP key

Remote Alarm setting (Refer to pages 48~54)	Connecting terminal	Normal condition	Abnormal condition (Including in the cases of power outage and of where the power supply plug is pulled out)	
			When pressing the BUZZER STOP key	
ON: Remote alarm setting not connected with BUZZER STOP key	COM.-N.C.	Close	Open	Open (Maintain in abnormality)*
	COM.-N.O.	Open	Close	Close (Maintain in abnormality)*
OFF: Remote alarm setting connected with BUZZER STOP key	COM.-N.C.	Close	Open	Close (Return to normal)
	COM.-N.O.	Open	Close	Open (Return to normal)

* In the case of Error01 (CO₂ gas empty), Error11 (CO₂ sensor error), the condition returns to normal.

Use a twisted shield wire for the connection.
 Type: UL 2343, UL 2448, UL 2464, UL 2552, UL2623.
 Length: 30 m max.

INSTALLATION

Installation site

For correct operation of the incubator, install it in a location with the following conditions.

- **Normal air environment**

Install the incubator in an environment with normal air.

- **Do not expose to direct sunlight**

Do not install the incubator in a location where it will be exposed to direct sunlight. If the incubator is operated in direct sunlight, performance will be adversely affected.

- **Separate from heat sources**

Do not install the incubator near significant heat sources, such as heaters, boilers, ovens, or autoclaves. Heat will adversely affect the performance of the incubator.

- **Ambient temperature at least 5 °C lower than set temperature**

The control temperature of the incubator is at least 5 °C higher than the ambient temperature. For example, if the chamber is controlled at 37 °C, the ambient temperature must be 32 °C or less. Do not allow the ambient temperature to become too high.

- **Strong and level floor**

Select a site with a strong and level floor. If the floor is uneven or the installation is not level, the incubator will be unstable and this may cause accident or injury. To avoid vibration and noise, always make sure that the installation is stable. An unstable surface may result in vibration or noise.

- **Separate from vibration products**

Do not install the incubator near vibration products. Vibration may cause culture failure.

- **Low humidity**

Select a site with a relative humidity of 80 %R.H. or lower. Using the incubator in high humidity may result in current leakage or electric shock.

- **No inflammable or corrosive gas**

Never install the incubator in a location where it will be exposed to inflammable or corrosive gas. Doing so may result in explosion or fire. In addition, insulation may deteriorate due to corrosion of protective casing, resulting in current leakage or electric shock.

- **No falling objects**

Do not install the incubator in a location where there is the possibility of objects falling from above. Doing so may result in damage or accident.

INSTALLATION

Installation

1. Remove the packing tape and clean up.

Remove all the tapes that are securing the doors and the inner attachments. Open the doors for ventilation. If the outer panels are dirty, use a cloth to wipe them with a diluted neutral detergent (Undiluted detergent can damage the plastic components. For the dilution, refer to the instructions on the detergent). Wipe off the residual detergent with a wet cloth and then wipe off any moisture.

Note: Remove the cable tie around the power supply cord to prevent corrosion of the cord coating.

2. Set up the humidifying pan and humidifying pan cover (Fig. 1).

3. Install 3 trays (Fig. 2).

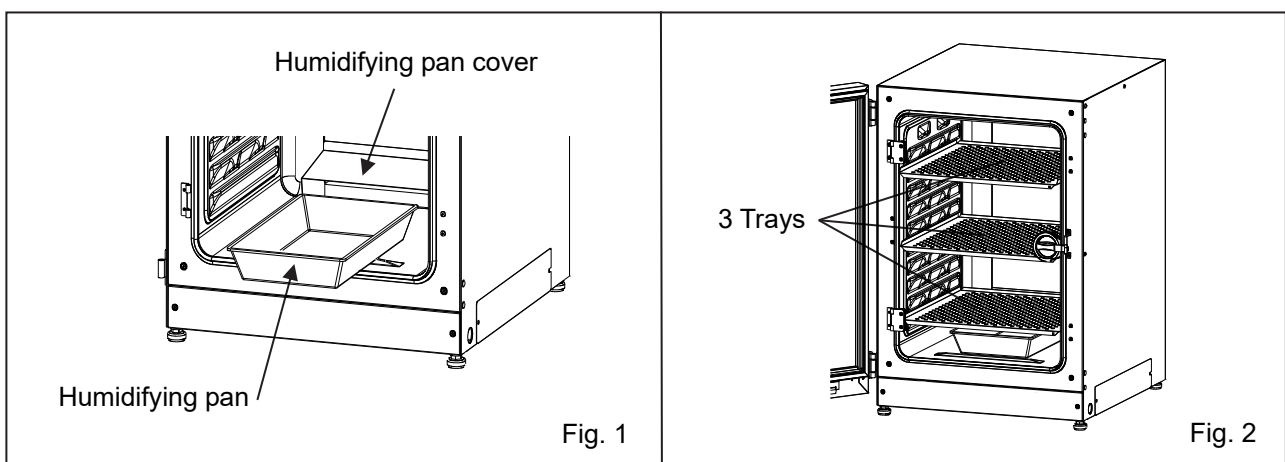

(When optional small doors (MCO-170ID) are installed)

To use the gastight split doors effectively, set 3 trays at the same level as shown in Fig 3 below.

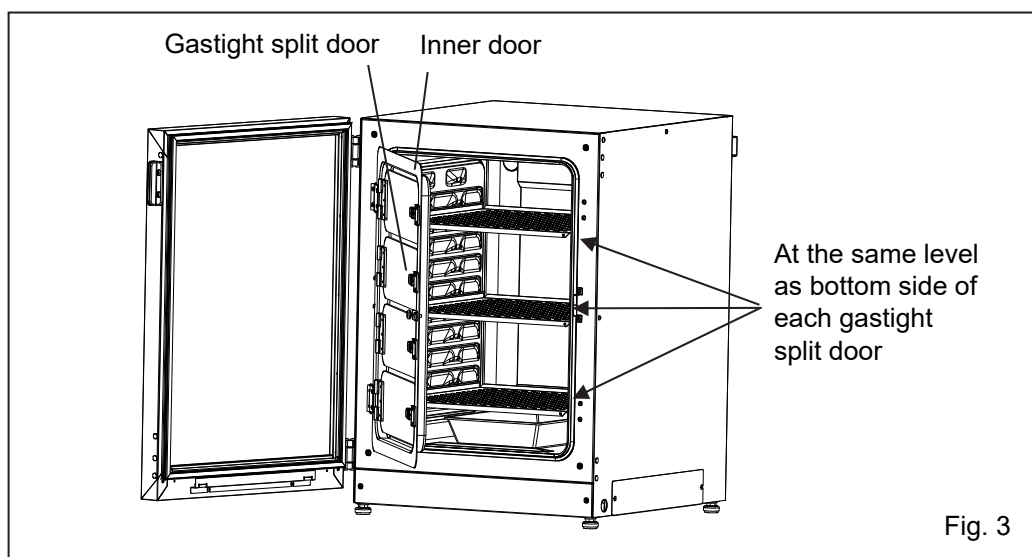

INSTALLATION

4. Adjust the leveling feet.

Adjust the leveling feet by turning them anticlockwise until the incubator is level (Fig. 4).

Note: Incubating on a sloping tray may adversely affect the cultivation.

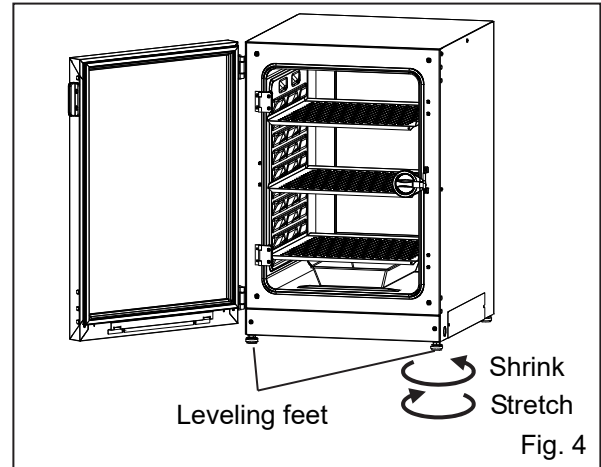

5. Earth the incubator.

Earth the incubator during installation to prevent electric shock. If there is no earth wire at the location, consult with qualified service personnel.

● When an earth must be installed

If an earthed 3-pole outlet is not available, then an earth must be installed. Consult with qualified service personnel.

● Installing an earth fault circuit breaker

If you must use the incubator in a moist or humid location, then it is recommended that an earth fault circuit breaker be installed in the power supply circuit (i.e., the power supply at the incubator). Have the circuit breaker installed by qualified service personnel.

● Double-stacking

For stacking the incubators securely, refer to the procedure included with the optional double-stacking bracket MCO-170PS or the stacking plate MCO-170SB.

Note: Two hooks are attached at the upper rear of the incubator. When stacking incubators, fix the upper incubator to the wall with these hooks and wire or chain (Fig. 5).

Note: When stacking the incubators with our CO₂ incubator or another O₂/CO₂ incubator, use the stacking plate MCO-170SB. Refer to Table 7 on page 77.

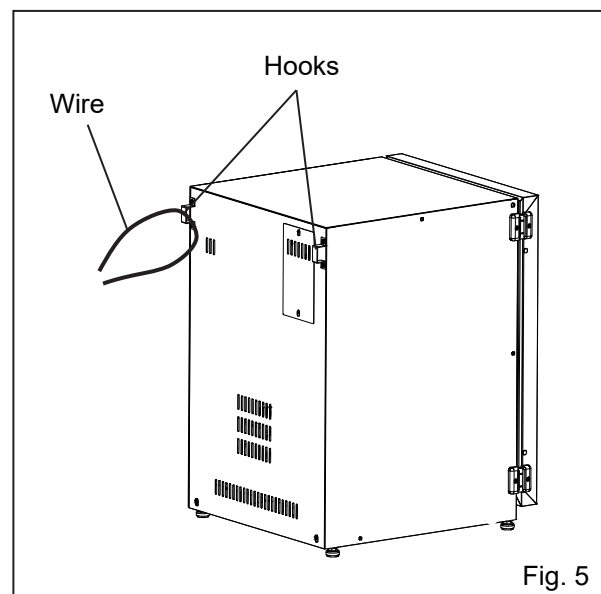

● When the incubator is not in use

Empty the water from the humidifying pan and remove moisture from the chamber. Make sure that the chamber is completely dry before closing the doors. Failure to do so may result in damage.

● Before moving the incubator

Before moving the incubator, empty the water from the humidifying pan, disconnect the power supply plug from the outlet, and make sure that the power supply cord will not be damaged. Failure to do so may result in electric shock or fire.

INSTALLATION

Connecting a CO₂ gas cylinder

WARNING

When connecting a gas cylinder to the incubator, **confirm the gas type. Confirm that the connections are secure and that no gas will leak. Be sure to use the specified pressure.** Using an incorrect gas or pressure may result in explosion or fire, or in gas poisoning or oxygen deprivation due to gas leak.

Install the incubator in a location with adequate ventilation. If adequate ventilation cannot be provided, then install an alarm system using CO₂ and O₂ densitometers.

1. Get a CO₂ gas cylinder ready and install an optional gas regulator MCO-010R.

Notes:

- Use a liquefied-CO₂ gas cylinder (at least 99.5 % pure). The siphon (dip tube) type cannot be used.
- When MCO-010R is not available, install a gas regulator rated at 25 MPa(G) (250 kgf/cm²(G), 3600 psi(G)) for the primary side, and 0.25 MPa(G) (2.5 kgf/cm²(G), 36 psi(G)) for the secondary side.

2. Using the gas tube provided, connect the connecting port A for the CO₂ gas pipe and the gas regulator of the CO₂ gas cylinder.

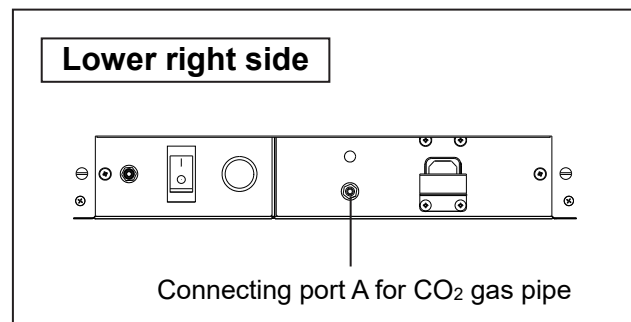

Notes:

- By using two tube bands provided, connect the gas tube tightly to prevent it from coming off.
- Make sure that the gas tube is not folded.
- If the CO₂ gas is supplied to multiple CO₂ incubators from a single gas cylinder, a CO₂ solid will be formed in the gas regulator. The gas regulator safety valve will operate, and there may be an explosive sound.

3. After connecting the gas tube, make sure that no gas is leaking (ex. by using a gas leak detector spray).

4. Set the CO₂ gas on the secondary side to 0.03 MPa(G)–0.1 MPa(G) (0.3 kgf/cm²(G)–1 kgf/cm²(G), 4.4 psi(G)–14.5 psi(G)) for gas injection. Recommended pressure: 0.03 MPa(G) (0.3 kgf/cm²(G), 4.4 psi(G)).

Note: As the pressure increases, the CO₂ gas density variation will increase. Excessive pressure may cause gas supply lines inside the incubator to come loose, which may result in gas poisoning or oxygen deprivation due to leaking gas. If gas lines come loose, the incubator must be repaired.

5. When there is no CO₂ gas left and the CO₂ gas empty alarm is activated, replace the empty gas cylinder.

Note: When the optional gas auto-changer MCO-21GC is installed, it switches the empty CO₂ gas supply line to the other automatically. Refer to pages 60~61.

Note:

- The gas lines connected to the incubator will degrade over time. If any deterioration or abnormalities are found during inspection, replace the lines immediately.
- Close the valve of the CO₂ gas cylinder when the CO₂ gas is not in use.

BEFORE COMMENCING OPERATION

Initial cleaning method

Before using the incubator for the first time, clean dirt (tape residue, smear, etc.) from the chamber and the inner attachments thoroughly.

Keeping the chamber clean is essential for efficient performance. Clean the chamber and all the inner attachments at least once a month. Use the following steps to clean the incubator properly. When these steps are not sufficient to remove dirt, contact our sales representative or agent.

1. Remove the inner attachments, referring to "Removing inner attachments" on pages 21~22.
2. Clean the inner attachments, the chamber inside walls, and the inner door gaskets with a cloth or sponge soaked in neutral detergent, diluted by 5 % or less (Fig. 1). (Undiluted detergent can damage the plastic components. For the dilution, refer to the instructions on the detergent.)

⚠ CAUTION

Do not use detergents or antiseptic solutions with acid, alkali, or chlorine. Doing so may cause discoloration, corrosion, or rusting.

Be careful to keep the diluted detergent or water out of the temperature sensor, the CO₂ gas injection hole, the fan motor shaft bearing, and the inner sample air outlet (marked on Fig. 2 by ◀). Also, do not wash the temperature sensor, CO₂ sensor and the UV lamp using detergent. Doing so may cause failure.

3. Soak a piece of gauze or unwoven cloth in distilled water, wring it out and wipe off the residual detergent thoroughly.
4. Wash the two silicon caps for the access port and the fan using the detergent and rinse them with distilled water, and then autoclave them for sterilization (121 °C, 20 minutes).
5. Wipe the inside walls and the inner attachments thoroughly with an unwoven cloth soaked in alcohol for disinfection. Be careful not to leave any alcohol residue.
6. Reinstall the inner attachments correctly and securely, referring to "Installing inner attachments" on page 23.

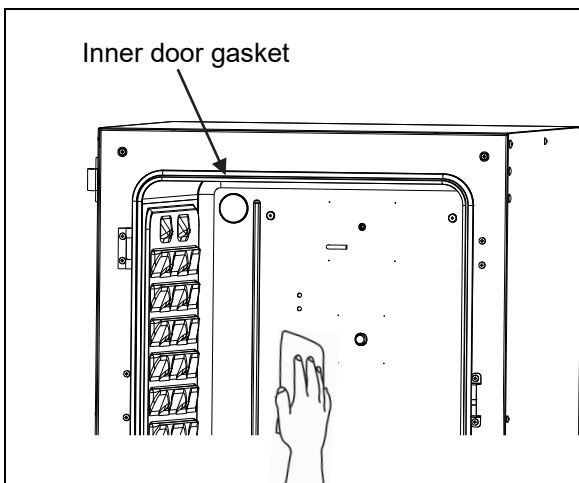

Fig. 1

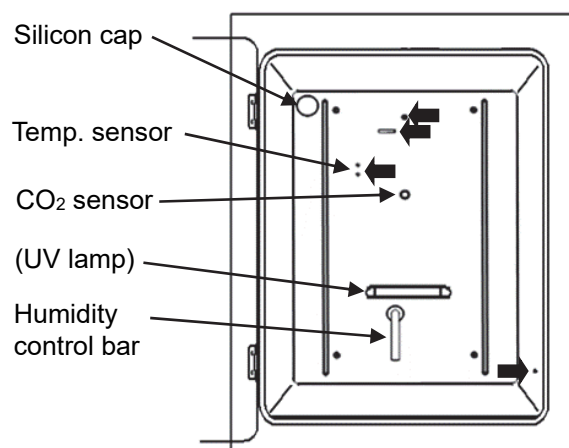

Fig. 2

BEFORE COMMENCING OPERATION

Removing inner attachments

Always replace the inner attachments after cleaning to maintain efficient performance.

Be careful not to damage the UV lamp in the duct (When an optional UV system set MCO-170UVS is installed).

1. Turn OFF the power to the incubator.

2. Open the outer and inner doors and pull out all the trays (Fig. 1).

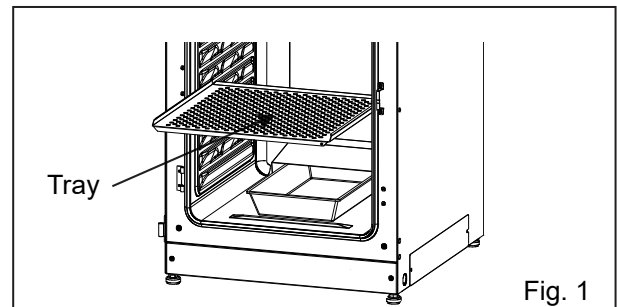

3. Pull out the humidifying pan (Fig. 2).

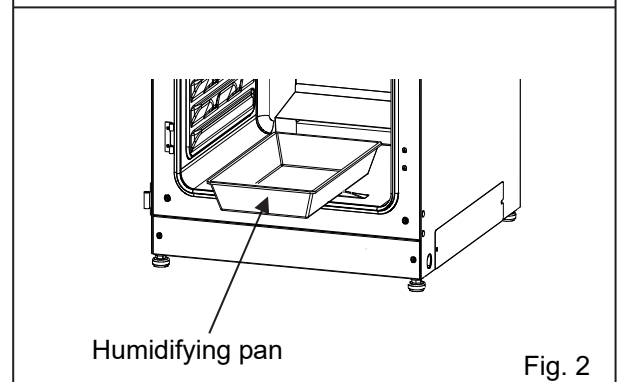

4. Pull out the humidifying pan cover (Fig. 3).

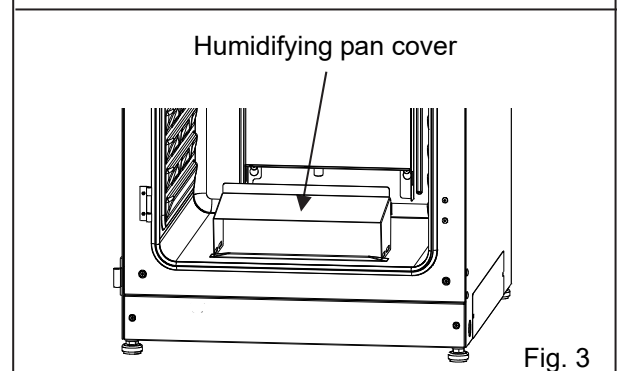

5. Pull out the fan cover (Fig. 4).

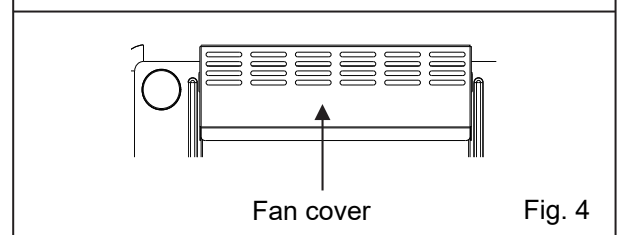

BEFORE COMMENCING OPERATION

6. Loosen the screws at the rear and lift out the duct (Fig. 5).

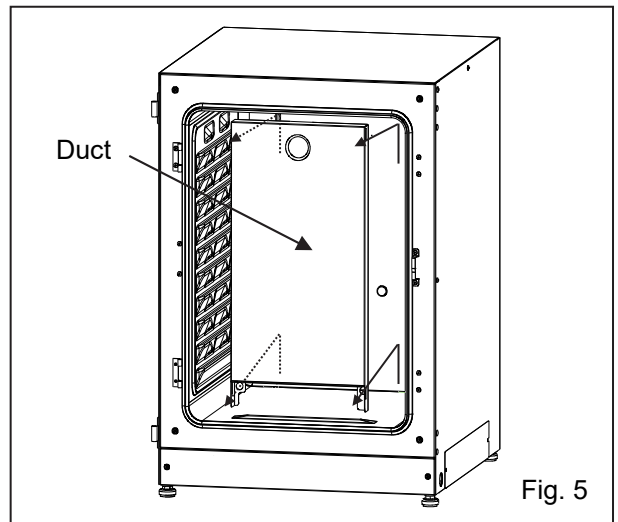

7. Pull out the fan (Fig. 6).

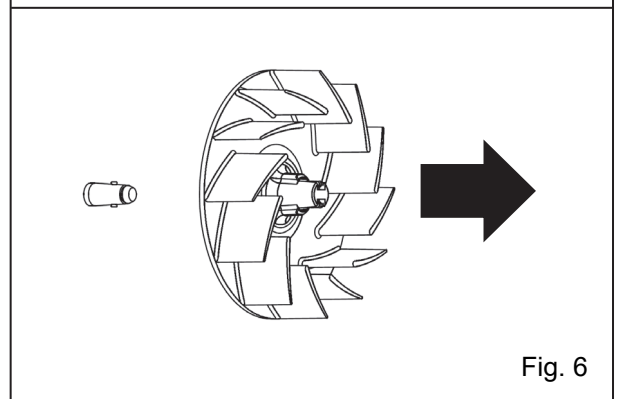

8. Remove the silicon caps for the access port from the interior (Fig. 7) and exterior (Fig. 8).

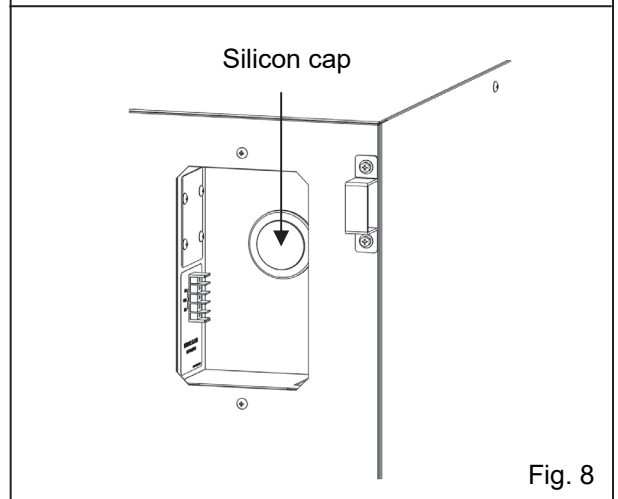
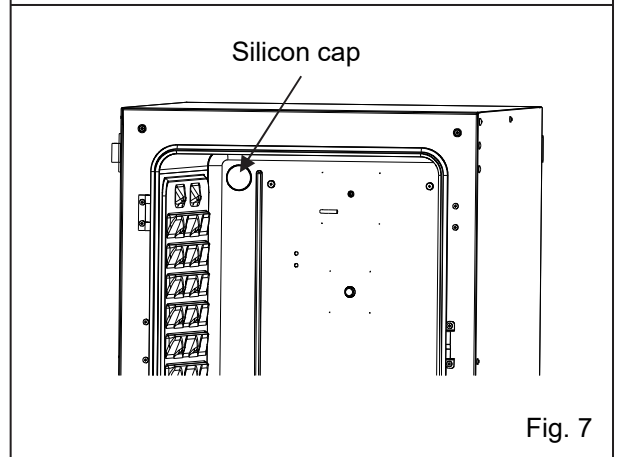

BEFORE COMMENCING OPERATION

Installing inner attachments

To reinstall all the attachments, perform the procedure in reverse order from step 8 on page 22.

Note: When installing the fan, attach it to the motor shaft securely. Lightly turn and pull the fan manually to make sure that it does not touch the rear panel and is secure (Fig. 1).

⚠ CAUTION

If the fan is not pushed fully in, the intended velocity cannot be achieved, which may cause culture failure or insufficient decontamination.

Note: To install the duct, check that four screws are securely inserted in the four holes of the duct (Fig. 2).

⚠ CAUTION

If the duct is fixed insecurely, the intended velocity cannot be achieved, which may cause culture failure or insufficient decontamination.

Note: When installing the fan cover, align the long hole of duct with the projection of the fan cover and push until it clicks into place (Fig. 3). The same applies for the humidifying pan cover.

Make sure that there is no space at the bottom of the fan cover after installing it. If the fan cover is incorrectly installed, it may adversely affect the chamber temperature distribution.

⚠ CAUTION

If the fan cover is fixed insecurely, the intended velocity cannot be achieved, which may cause culture failure.

Note: Position the tray with the front edge bent down (Fig. 4).

1. Position the center hole of the fan with the projection of the motor shaft. And insert it deeply.



2. Lightly turn the fan manually to make sure that it does not touch the rear panel.

3. Lightly pull the fan manually to make sure that it is installed.

Fig. 1

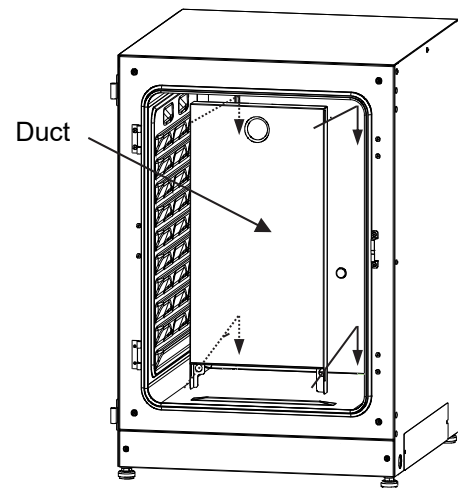
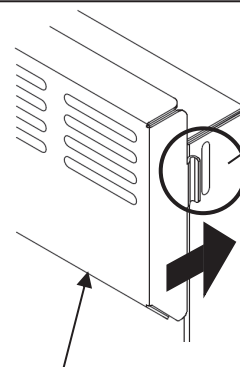

Fig. 2



1. Position and insert.

2. Confirm the direction of fixing position as shown.

3. Make sure that there is no space at the lower of fan cover.

Fig. 3

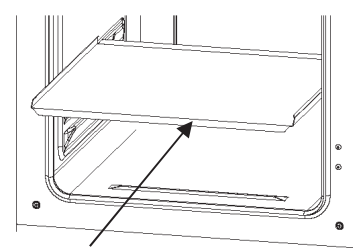

Bent down

Fig. 4

BEFORE COMMENCING OPERATION

Filling the humidifying pan

Use the following procedure to fill the humidifying pan with water or to replace water in it.

1. Pull out the humidifying pan (Fig. 1).
2. Dispose of the remaining water and clean the humidifying pan with a diluted detergent. Then rinse it thoroughly with distilled water and wipe it with alcohol for disinfection.
3. Wipe all moisture from the bottom of the chamber.
4. Return the humidifying pan to the chamber and fill with sterile distilled water (approx. 1.5 L, preheated to 37 °C) (Fig. 2).

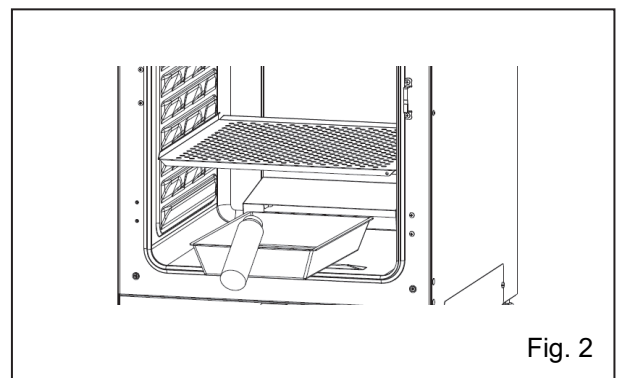
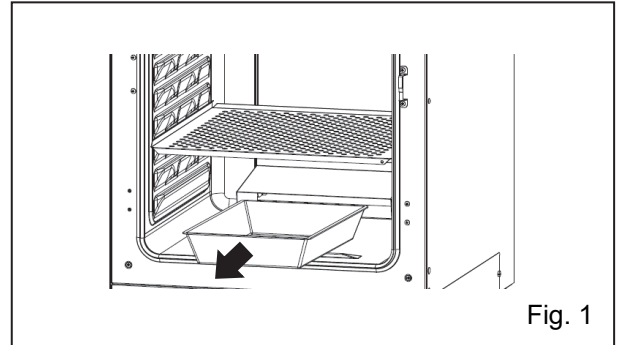

Notes:

- Operation with no water for humidifying may increase the chamber temperature than the set temperature temporarily.
- Preheat the water to 37 °C. Adding cool water will lower the temperature and humidity in the chamber.
- Install the humidifying pan in a longitudinal direction with its shorter side placed at the back.
- Refill the humidifying pan with water promptly when the volume of water decreases.
- Mixing any reagent into the water for humidifying may have an adverse effect on the cultivation. Do not add any reagent to the water when using the UV lamp, as the UV light may cause the mixture to deteriorate.
- After cleaning, please change the water of the humidifying pan. There is a possibility that it can not be controlled correctly due to the influence of alcohol.

5. Place the humidifying pan with the inner side flush against the back, and close the inner and outer doors.

Note: The humidity control bar in the duct maintains low temperature and inner moisture is recondensed. Slide the humidifying pan down right under the humidity control bar, otherwise the recondensed water droplets will fall directly to the bottom of the chamber forming a pool. When the pooled water evaporates, it may leave a white mark on the bottom. This is not a malfunction. Wipe it off with a piece of gauze or unwoven cloth soaked in alcohol. If the mark cannot be removed, scrub it off using a cleansing cream.

FOR OPTIMAL CULTIVATION

Precautions for cultures

- **Leave space between culture containers.**

Always leave space for ventilation between culture containers (Petri dishes, flasks, etc.). Inadequate spacing may result in uneven temperature distribution and CO₂ gas density.

- **Do not place harmful materials in the chamber.**

Never place samples that release acidic, alkaline, or corrosive gas into the chamber. Doing so may cause damage resulting from discoloration or corrosion.

- **Close the inner door.**

Always close the inner door before closing the outer door. Failure to close the inner door will adversely affect performance even if the outer door is closed.

- **Open and close the doors gently.**

Closing the doors forcefully may cause spillage of the culture medium, incomplete closing, or damage to the gasket. Before opening the inner door, check through the glass to confirm that the UV lamp is OFF (When an optional UV system set MCO-170UVS is installed).

- **Be careful when closing the outer door.**

Use the handle when closing the outer door. Not doing so may cause injury by getting fingers caught in the door. Do not lean on the outer door. Doing so may result in injury from the outer door coming loose or the incubator falling over, or may cause current leakage or electric shock.

- **Be careful of the inside of the outer door.**

The inside of the outer door may become hot.

- **Avoid using excessive force on the inner door.**

Do not put your hand on the glass, poke it with sharp objects, or apply strong force. Doing so may result in injury from breaking the glass.

- **Check the cause of any alarm buzzer.**

If an alarm buzzer sounds while the incubator is in use, check the cause of the alarm immediately. For details on what may cause an alarm buzzer to sound, refer to pages 67~69.

- **Vibration of a shaker.**

When incubators are stacked, operation of a shaker in the chamber of the CO₂ incubator may adversely affect the other incubator.

- **Thermal conductivity CO₂ sensor**

It is not abnormal that the thermal conductivity CO₂ sensor displays CO₂ density higher than the actual density when the chamber humidity temporarily goes down. And take care of the level of humidifying water because the lack of water affects the CO₂ density.

FOR OPTIMAL CULTIVATION

Preventing contamination

To prevent contamination of the chamber, select a suitable installation site.

- **Avoid locations with high temperatures or humidity** where the air may contain more microorganisms.
- **Do not place the incubator near doors, air conditioners, fans, etc.**, where draughts and passage of bodies may increase the risk of microorganisms entering the chamber.
- **If possible, use a cleanroom.**
- **Use clean containers.** Dirty containers are the greatest cause of contamination for cultures. Be careful not to get containers or trays dirty when taking them in and out.
- **Keep the chamber clean.** Wipe off any fingerprints. If water spills from the humidifying pan, or if the doors are left open for a long time, condensation may form on the inside of the doors. Wipe off condensation with a piece of dry sterile gauze. In particular, clean and disinfect the chamber if the culture medium is spilled.
- **Use sterile distilled water in the humidifying pan and change it once a week.** Do not use ultrapure water, which may cause red rust-like particles in the humidifying pan. Clean the humidifying pan once a month.
- **Keep the incubator out of direct airflows from air conditioners or fans.** Cool airflow from an air conditioner may cause condensation and lead to possible contamination.

CORRECT OPERATION

Use the following procedure to start trial operation or actual operation of the incubator.

1. Install the incubator correctly, referring to pages 16~19.
2. Remove the packing materials from the chamber and inner attachments. Clean and disinfect the chamber and all the inner attachments, referring to page 20.
3. Add approximately 1.5 L of sterile distilled water to the humidifying pan. (Refer to page 24.)
4. Connect the removable power supply cord to the port on the lower right side.

Note : For the MCO-170ACL-PE for EU countries, two removable power supply cords are provided.

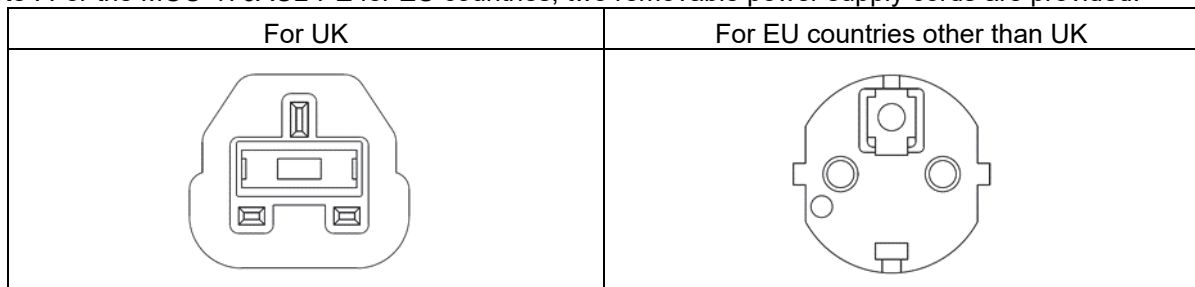

5. Connect the removable power supply cord to the outlet.
 6. Turn ON the power switch on the lower right side of the incubator.
- The removable power supply cord provided is only for this product. Never use it for any other products.

HOME SCREEN

The display has a right side and a left side.

When the power is switched ON, the home screen that shows the internal temperature, CO₂ density, etc. will be displayed.

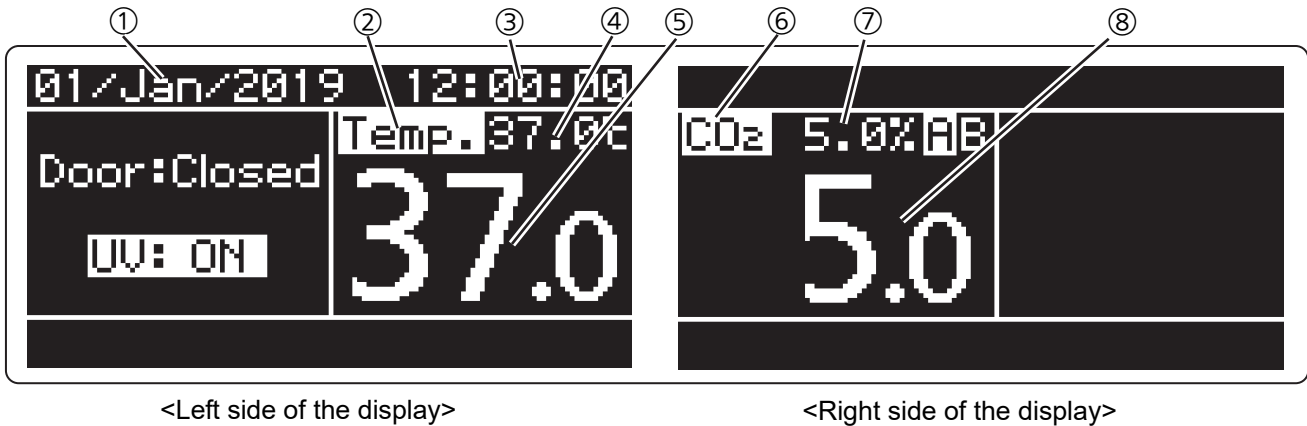

① Date display

Displays the current date. (See pages 63~64 for setting instructions)

② Heating indicator

Highlighted when the heater is on.

③ Time display

Displays the current time. (See page 65 for setting instructions)

④ Set temperature display

Displays the setting value of the internal temperature. (See page 32 for setting instructions)

Factory setting: 37°C

⑤ Current temperature display

Displays the current value of the internal temperature. It blinks when the current value of the internal temperature exceeds the set temperature warning range.

⑥ CO₂ gas injection indicator

Highlighted while CO₂ gas is injected into the vessel.

⑦ Set CO₂ density level display

Displays the set CO₂ density in the vessel. (See page 34 for setting instructions)

Factory setting: 0% (OFF)

If the CO₂ control setting value is OFF, it displays "OFF".

⑧ Current CO₂ density display

Displays the current value of CO₂ density values in the vessel. It is not displayed if the CO₂ control setting value is OFF.

It blinks if the CO₂ control setting value is ON and the current value of the internal CO₂ density deviates from the CO₂ control set range.

HOME SCREEN

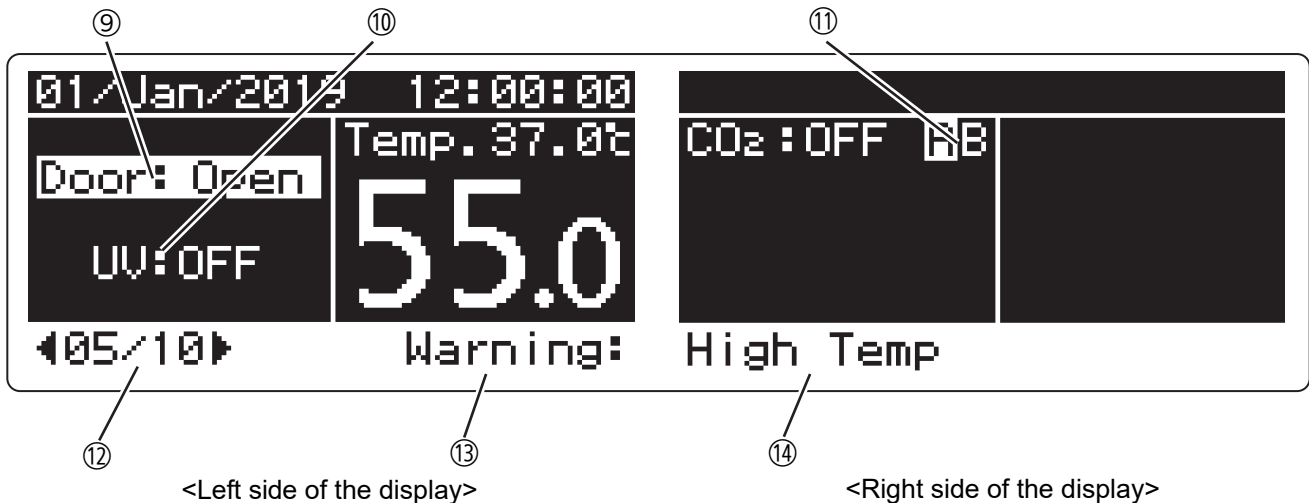

⑨ Outer door opened/closed status display

Outer door open: "Door:Open" is highlighted.
Outer door closed: "Door:Closed" will be displayed.

⑩ UV lamp status display

For when using the optional UV lamp.
If the UV lamp is lit: "UV:ON" is highlighted.
If the UV lamp is off: "UV:OFF" will be displayed.

⑪ CO₂ gas supply line indicator A and B

When using the separately sold automatic CO₂ gas switching equipment, the CO₂ supplying CO₂ gas supply line (CO₂ gas pipe connection port) currently in use is highlighted.
It blinks if the CO₂ cylinder is empty. (See pages 60~62 for reference)

⑫ Message count display

If the total number of messages is more than 1, it will be displayed.
The display shows the "number of the message currently displayed/total number of messages".
If the left/right keys (◀▶) are displayed, the contents of the message number can be switched using the left and right keys.

⑬ Error/Alarm display

Displays the currently occurring error/alarm. (See pages 67~68)

If there is an error: "ErrOO" (OO is the error code) will be displayed
If it's an alarm: "Warning" will be displayed.

⑭ Message display

Errors/Alarms/Other messages are displayed accordingly. (See pages 67~68)

Notes:

The display starts scrolling from right to left once the unit is in the following four conditions.

- Not in an alarm condition (no error messages are displayed).
- Temperature display and CO₂ density display with no blinking.
- The outer door is closed.
- No keys being pressed over 30 seconds.

Scrolling can be stopped in either one of the following conditions.

- In an alarm condition (error messages are displayed).
- Temperature display or CO₂ density display with blinking.
- The outer door is opened.
- Any key is pressed.

MENU SCREEN

On the home screen, pressing the menu key (MENU/HOME) displays the Menu screen on the on the left side. The Menu screen is set up as follows:

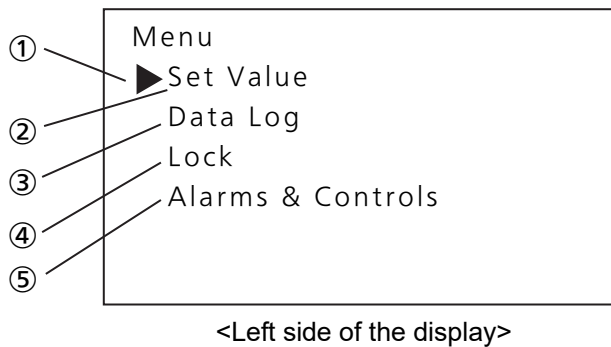

① Cursor

It is used to select menu items. Move with the up/down keys (Δ / ∇).

② Internal temperature/CO₂ density/overheating prevention temperature setting

Select to change the settings of the internal temperature/CO₂ density/overheating prevention temperature. Move the cursor to this item and press the enter key (ENTER) to go to the setting screen.

③ Log display/output

Select this when displaying various log data on screen or to output it to a USB memory. Move the cursor to this item and press the enter key (ENTER) to go to the Data Log screen.

④ Key lock settings

Select this when changing key lock settings. Move the cursor to this item and press the enter key (ENTER) to go to the Lock screen.

✧ Settings can be locked to prevent incorrect configuration changes. If set to ON, settings can not be changed even by operating the keys on the control panel.

⑤ Alarm settings and other settings

Select for changing alarm settings or other settings. Move the cursor to this item and press the enter key (ENTER) to go to the Alarms & Controls screen.

MENU SCREEN

Following shows the screen display and function at each screen under Menu level.

Note: The unit will return from setting mode to the home screen automatically after 90 seconds if no key is operated (auto-return function). In this case, the setting is not changed.

Screen	Function	Page
Set Value screen		
Temperature	(Setting) chamber temperature	32
CO ₂ ON/OFF	(Setting) CO ₂ gas control mode	33
CO ₂ Setting	(Setting) CO ₂ density	34
Overtemp	(Setting) high limit temperature alarm	35
Data Log screen		
Data Log Chart	(Display) operation log graph (can be exported)	36-38
Data Log Export	(Export) operation log	39-40
Data Log Setting	(Setting) log interval, Unique ID	41-42
Alarm	(Display) alarm log	43
Alarm Export	(Export) alarm log	44-45
Lock screen		
Keypad Lock	(Setting) Key lock ON/OFF, password	46-47
Alarms & Controls screen		
Temp/Gas Alarm Set screen		
Temp Alarm	(Setting) automatic set temperature alarm	48
Temp Alarm Delay	(Setting) automatic set temperature alarm delay	49
CO ₂ Alarm	(Setting) automatic set CO ₂ density alarm	50
CO ₂ Alarm Delay	(Setting) automatic set CO ₂ density alarm delay	51
Other Alarm Set screen		
Door Alarm Delay	(Setting) door alarm delay	52
Ring Back Delay	(Setting) ring back delay	53
Remote Alarm	(Setting) remote alarm	54
UV Setting ※1		
UV Lighting Time	(Setting) UV lamp ON period	56
UV Life Counter	(Display) UV lamp life indication	57
Auto-Extended Time	(Display) UV timer extension	58
UV 24h Mode Start	(Setting) Lighting UV lamp for 24 hours	59
Gas Supply Setting ※2		
CO ₂ Supply	(Setting) Manual CO ₂ gas supply line A/B changeover	60-62
Date & Time screen		
Date Format	(Setting) date display (format)	63
Date	(Setting) date	64
Time	(Setting) time	65
Keypad Click Set screen		
Keypad Click Set	(Setting) keypad click	66
DAQ Setting screen ※3	Don't push (Only for MTR-5000 user)	
Calibration screen ※4	Don't push (Qualified engineer only)	

※1 : When an optional UV system set MCO-170UVS is installed.

※2 : When an optional gas auto changer MCO-21GC is installed.

※3 : Only when using an optional software product Data acquisition system MTR-5000.

※4 : Service key is not available. (Qualified engineer only)

BASIC PARAMETERS

Setting temperature

Set the chamber temperature normal operation according to the following procedure. The incubator automatically starts operation using these settings after power-on.

- Settable range : 0.0 °C~50.0 °C
- Factory setting : 37.0 °C

1. On the home screen, press the menu key (MENU/HOME).
▶ The left side of the display will change to the Menu screen.

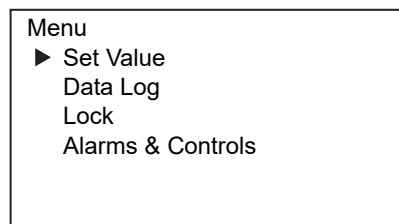

<Left side of the display> [Fig. 1]

2. When the cursor on the menu screen is on Set Value [Fig. 1], press the enter key (ENTER).

▶ The display will change to the Set Value screen.

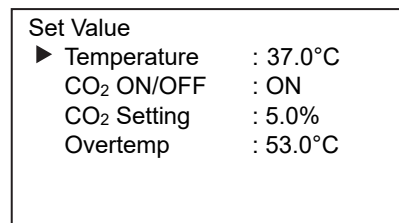

<Left side of the display> [Fig. 2]

3. When the cursor on the Set Value screen is on Temperature [Fig. 2], press the enter key (ENTER).

▶ The right side of the display will change to the Temperature screen, and the current set value (37.0) will be displayed [Fig. 3].

4. Move the cursor using the left/right keys (◀▶) and select the digit you want to change, and then use the up/down keys (▲▼) to change the number.

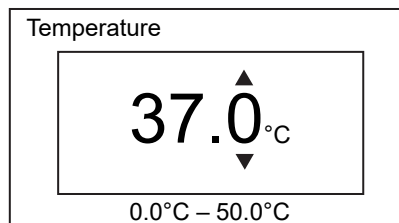

<Right side of the display> [Fig. 3]

5. Press the enter key (ENTER).

▶ The input value will be confirmed and you will be returned to the Set Value screen.

*If the entered setting value is out of the setting range, the following screen will be displayed on the right side of the display: Press any key on the control panel to change to the Temperature screen [Fig. 3].

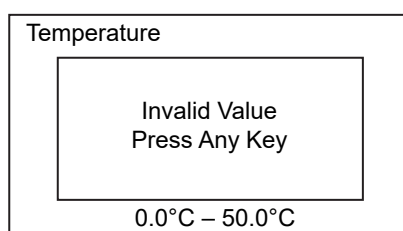

<Right side of the display>

6. Press the menu key (MENU/HOME) to display the home screen.

◇The display returns to the home screen automatically when 90 seconds has passed without any key operation.

BASIC PARAMETERS

Setting CO₂ gas

Set the CO₂ gas control mode normal operation according to the following procedure. The incubator automatically starts operation using these settings after power-on.

- Setting values : ON, OFF
- Factory setting : OFF

1. On the home screen, press the menu key (MENU/HOME).
▶ The left side of the display will change to the Menu screen.
2. When the cursor on the menu screen is on Set Value [Fig. 1], press the enter key (ENTER).
▶ The display will change to the Set Value screen.
3. Move the cursor on the Set Value screen to CO₂ ON/OFF [Fig. 2] using the up/down keys (△▽), and press the enter key (ENTER).
▶ The left side of the display will change to the CO₂ ON/OFF screen, and the current set value (ON) will be displayed [Fig. 3].
4. Use the up/down keys (△▽) to change the control setting value.
◇ Each time the up/down key is pressed the input value will change between ON and OFF.
5. Press the enter key (ENTER).
▶ If it is set to ON: the input value will be confirmed and the display will change to the CO₂ Setting screen.
If it is set to OFF: the input value will be confirmed and the display will change to the Set Value screen.
6. Press the menu key (MENU/HOME) to display the home screen.
◇ The display returns to the home screen automatically when 90 seconds has passed without any key operation.

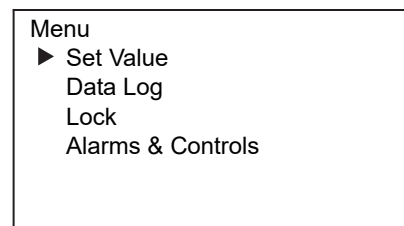

<Left side of the display> [Fig. 1]

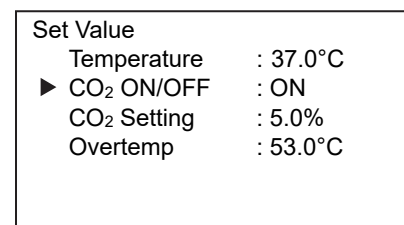

<Left side of the display> [Fig. 2]

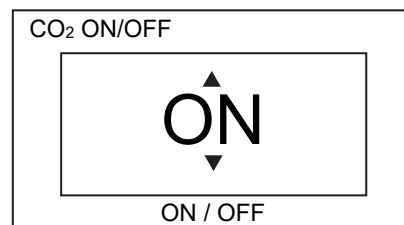

<Right side of the display> [Fig. 3]

BASIC PARAMETERS

Setting CO₂ density

Set the CO₂ density normal operation according to the following procedure. The incubator automatically starts operation using these settings after power-on.

- Settable range : 0.0 %~20.0 %
- Factory setting : 0.0 %

Note:

· When operating the incubator for the first time or after not using it for an extended period of time, operate it for at least about 8 hours until the chamber temperature and the CO₂ sensor are stable after setting the chamber temperature to the desired temperature and setting the CO₂ density to 0 %. Then change the setting to the desired CO₂ density.

1. On the home screen, press the menu key (MENU/HOME).

▶ The left side of the display will change to the Menu screen.

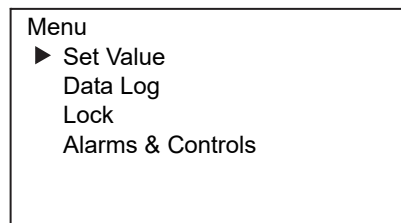

<Left side of the display> [Fig. 1]

2. When the cursor on the menu screen is on Set Value [Fig. 1], press the enter key (ENTER).

▶ The display will change to the Set Value screen.

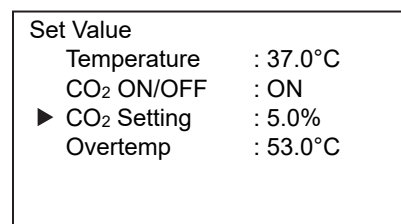

<Left side of the display> [Fig. 2]

3. Move the cursor on the Set Value screen, to CO₂ Setting [Fig. 2] using the up/down keys (△▽), and press the enter key (ENTER).

▶ The right side of the display will change to the CO₂ Setting screen, and the current setting value (05.0) will be displayed [Fig. 3].

4. Move the cursor using the left/right keys (◀▶) and select the digit you want to change, and then use the up/down keys (△▽) to change the number.

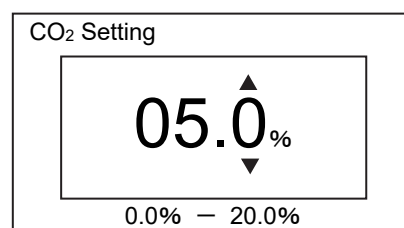

<Right side of the display> [Fig. 3]

5. Press the enter key (ENTER).

▶ The input value will be confirmed and you will be returned to the Set Value screen.

*If the entered setting value is out of the setting range, the following screen will be displayed on the right side of the display: Press any key on the control panel to change to the CO₂ Setting screen [Fig. 3].

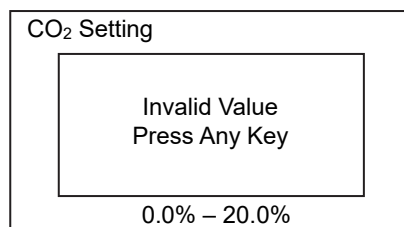

<Right side of the display>

6. Press the menu key (MENU/HOME) to display the home screen.

◇ The display returns to the home screen automatically when 90 seconds has passed without any key operation.

BASIC PARAMETERS

Setting high limit temperature alarm

The high limit temperature alarm is different from the Automatic set temperature alarm (page 48), and it is independent temperature alarm. In case the chamber temperature exceeds the temperature of the high limit temperature alarm, this alarm is activated.

Set the High Limit normal operation according to the following procedure. The incubator automatically starts operation using these settings after power-on.

- Settable range : 20.0 °C~53.0 °C
- Factory setting : 53.0 °C

Note:

- Set the temperature of the high limit temperature alarm after the chamber temperature is stable at the set value.
- Set the high limit temperature alarm to at least 1 °C higher than the chamber set temperature.

1. On the home screen, press the menu key (MENU/HOME).
▶ The left side of the display will change to the Menu screen.

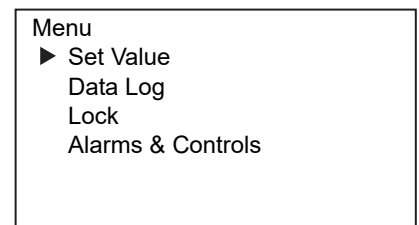

<Left side of the display> [Fig. 1]

2. When the cursor on the menu screen is on Set Value [Fig. 1], press the enter key (ENTER).
▶ The display will change to the Set Value screen.

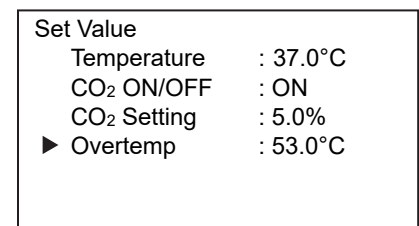

<Left side of the display> [Fig. 2]

3. Move the cursor on the Set Value screen to Overtemp [Fig. 2] using the up/down keys (Δ / ∇), and press the enter key (ENTER).
▶ The right side of the screen will change to the Overtemp screen, and the current setting value (53.0) will be displayed [Fig.3].

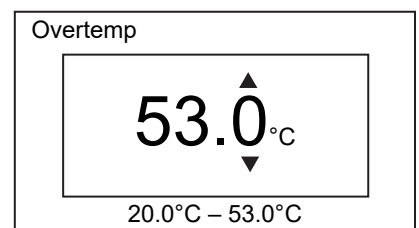

<Right side of the display> [Fig. 3]

4. Move the cursor using the left/right keys (\triangleleft / \triangleright) and select the digit you want to change, and then use the up/down keys (Δ / ∇) to change the number.

5. Press the enter key (ENTER).

▶ The input value will be confirmed and you will be returned to the Set Value screen.

*If the entered setting value is out of the setting range, the following screen will be displayed on the right side of the display: Press any key on the control panel to change to the Overtemp screen [Fig. 3].

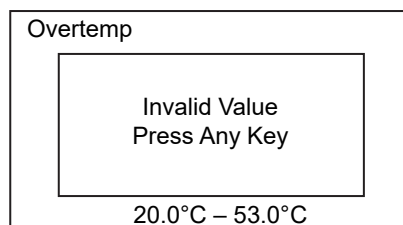

<Right side of the display>

6. Press the menu key (MENU/HOME) to display the home screen.

◇The display returns to the home screen automatically when 90 seconds has passed without any key operation.

OPERATION/ALARM LOG

Displaying operation log

The product's operation history can be graphically displayed on the display. Furthermore, it is possible to output these records to USB memory.

- Graph display setting: internal temperature, CO₂ density, and the door opening and closing records.
- Initial display: Internal temperature display

1. On the home screen, press the menu key (MENU/HOME).
 ▶ The left side of the display will change to the Menu screen.

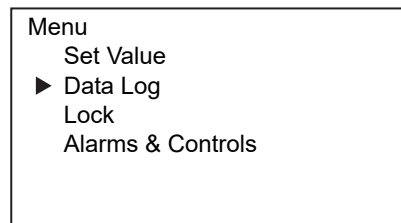

<Left side of the display> [Fig. 1]

2. Move the cursor on the Menu screen to Data Log [Fig. 1] using the up/down keys (Δ∇), and press the enter key (ENTER).

▶ The display will change to the Data Log screen.

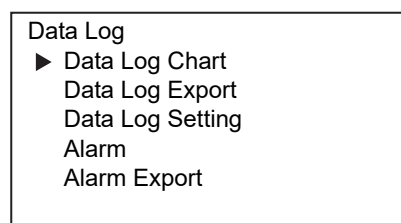

<Left side of the display> [Fig. 2]

3. On the Data Long screen, match the cursor to Data Log Chart [Fig. 2] and press the enter key (ENTER).

▶ The left side of the display will change to the graph display screen, and the current setting value (internal temperature graph displayed) will be displayed. [Fig. 3]

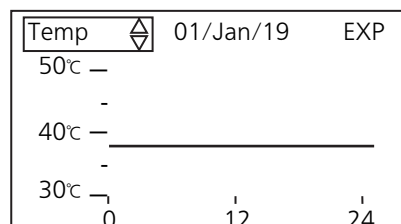

<Right side of the display> [Fig. 3]

4. With Temp on the upper left of the screen highlighted, press the enter key (ENTER).

▶ The display will change to the Data Select screen and the current setting value (TEMP) will be displayed. [Fig. 4]

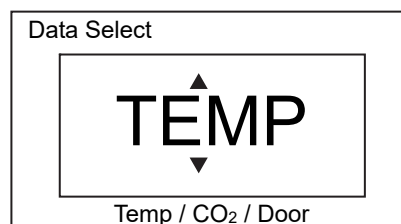

<Right side of the display> [Fig. 4]

5. Use the up/down keys (Δ∇) to select the data item to display in a graph.

◇ Each time the up/down key is pressed the screen display will change between Temp, CO₂, and Door.

Temp: the record of internal temperatures

CO₂: the record of internal CO₂ densities

Door: the door opening/closing record

6. Press the enter key (ENTER).

▶ A graph of the data will be displayed. [Fig. 5]

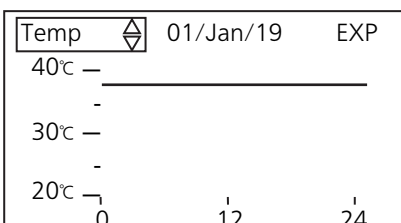

<Right side of the display> [Fig. 5]

*Door opening/closing record graph display [Fig. 6]

OP: Door opened

CL: Door closed

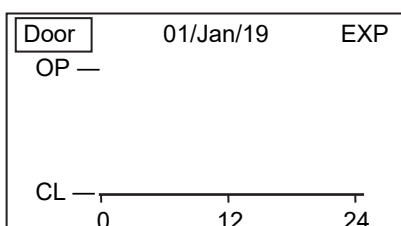

<Right side of the display> [Fig. 6]

OPERATION/ALARM LOG

*When the graph will be displayed and the graph item on the upper left of the screen is highlighted, and you press the [Fig. 5] up/down key ($\Delta \nabla$), the range of the vertical axis of the graphs will change as shown in the table.

Graph item	Display range
Temp	60°C ~ 50°C ~ 40°C
	↑ ↓
	Default values 50°C ~ 40°C ~ 30°C
	↑ ↓
	40°C ~ 30°C ~ 20°C
CO ₂	30°C ~ 20°C ~ 10°C
	↑ ↓
	20°C ~ 10°C ~ 0°C
	↑ ↓
	25% ~ 20% ~ 15%
Door	↑ ↓
	20% ~ 15% ~ 10%
	↑ ↓
	15% ~ 10% ~ 5%
	Default values 10% ~ 5% ~ 0%
Door	OP, CL

7. With the data item (Temp, CO₂, or Door) on the upper left of the display highlighted [Fig. 5], press the right key (\triangleright).

▶ The date will be highlighted. [Fig. 7]

8. Use the up/down keys ($\Delta \nabla$) to select the date of the data to display in a graph.

◇ Each time the up/down key is pressed the date will go back or forth 1 day, and the data from the selected date will be displayed in a graph.

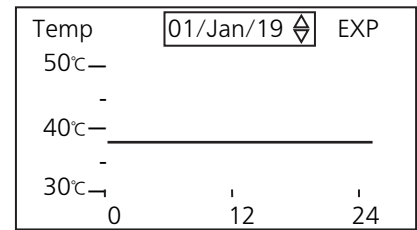

<Right side of the display> [Fig. 7]

*If you press the enter key (ENTER) instead of the up/down keys ($\Delta \nabla$), the display will change to the Date Select screen [Fig. 8], so after using the left/right keys ($\triangleleft \triangleright$) to move the cursor to the digit you want to change, change the numerical value using the up/down keys ($\Delta \nabla$).

9. Press the enter key (ENTER).

▶ The data from the selected date will be displayed in a graph.

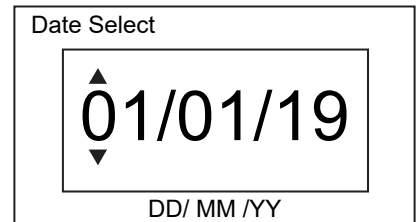

<Right side of the display> [Fig. 8]

*If the entered setting value is out of the setting range, the following screen will be displayed on the right side of the display: Press any key on the control panel to change to the Date Select screen [Fig. 8].

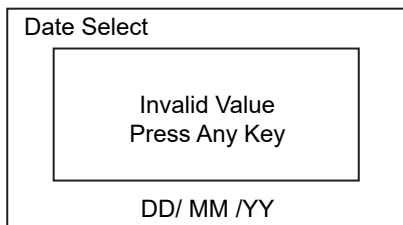

<Right side of the display>

Note:

· The CO₂ sensor is not stable during initializing of the Gas sensor. Therefore the CO₂ density log data may be different from the true value.

OPERATION/ALARM LOG

<When outputting data to USB memory>

The operation history record of the selected date is output as a CSV file.

10. With the date display highlighted in the graph [Fig. 9], press the right key (▷).

▶ The EXP in the upper right of the display is highlighted [Fig. 10].

11. Insert the USB memory into the USB port.

Note: It is not possible to use a USB memory with security functions that requires entering password.

12. Press the enter key (ENTER). The data will be output.

▶ While the data is being output, "Exporting" will be displayed on the right side of the display [Fig. 11].

13. When outputting is complete, "Export complete" will be displayed [Fig. 12]. Press any key to return to the graph display screen.

Note: Even after the export of operation log data is complete, operation log data saved in the incubator are not deleted.

*The following messages may come up on the right side of the display:

USB memory is disconnected: USB memory is not inserted

USB memory is full: there is no available space in the USB memory

An error occurred: failed to output to USB memory

No Data: there is no data to output

▶ Press any key on the control panel to return to the graph display screen.

14. Remove the USB memory from the USB port.

15. Press the menu key (MENU/HOME) to display the home screen.

◇The display returns to the home screen automatically when 90 seconds has passed without any key operation.

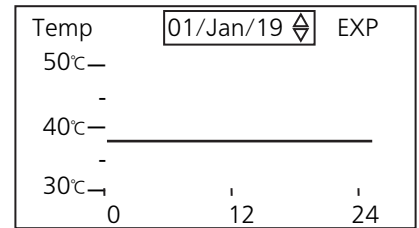

<Right side of the display> [Fig. 9]

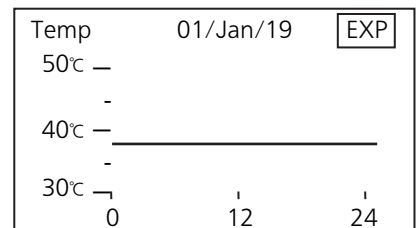

<Right side of the display> [Fig. 10]



<Right side of the display> [Fig. 11]



<Right side of the display> [Fig. 12]

OPERATION/ALARM LOG

Exporting operation log

It is possible to output the internal temperature/CO₂ density/door opening and closing records to a USB memory.

- Record output range: All, Specified date (1 day only)

1. Insert the USB memory into the USB port.

Note: It is not possible to use a USB memory with security functions that requires entering password.

2. On the home screen, press the menu key (MENU/HOME).
▶ The left side of the display will change to the Menu screen.

3. Move the cursor on the Menu screen to Data Log [Fig. 1] using the up/down keys (Δ / ∇), and press the enter key (ENTER).
▶ The display will change to the Data Log screen.

4. Move the cursor on the Data Log screen to Data Log Export [Fig. 2] using the up/down keys (Δ / ∇), and press the enter key (ENTER).
▶ The display will change to the Data Log Export screen [Fig. 3].

5. To output a record of a specific date, move the cursor to 24 Hours and press the enter key (ENTER).
▶ The right side of the display will change to the Date Select screen [Fig. 4].

6. Move the cursor using the left/right keys (\triangleleft / \triangleright) and select the digit you want to change, and then use the up/down keys (Δ / ∇) to change the number.

7. Press the enter key (ENTER). The record from the set date will be output to the USB memory.
▶ While the data is being output, "Exporting" will be displayed on the right side of the display [Fig. 5].

*If the entered setting value is out of the setting range, the following screen will be displayed on the right side of the display: Press any key on the control panel to change to the Date Select screen [Fig. 4].

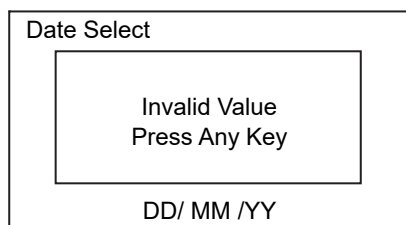

<Right side of the display>

*To output all saved records, select ALL in step 5 and press the enter key (ENTER).

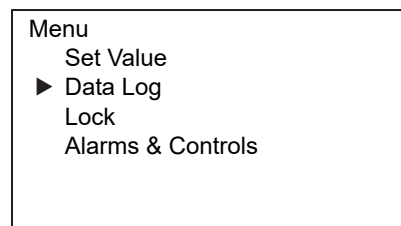

<Left side of the display> [Fig. 1]

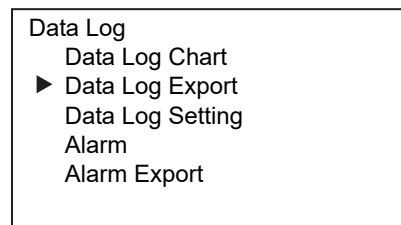

<Left side of the display> [Fig. 2]



<Left side of the display> [Fig. 3]

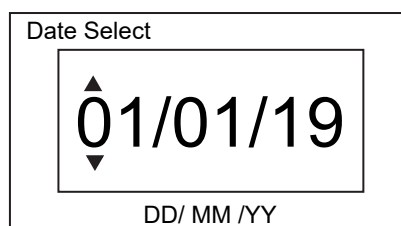

<Right side of the display> [Fig. 4]



<Right side of the display> [Fig. 5]

OPERATION/ALARM LOG

8. When outputting is complete, "Export complete" will be displayed [Fig. 6]. Press any key to return to the Data Log Export screen.

Note: Even after the export of operation log data is complete, operation log data saved in the incubator are not deleted.

*The following messages may come up on the right side of the display:
 USB memory is disconnected: USB memory is not inserted
 USB memory is full: there is no available space in the USB memory
 An error occurred: failed to output to USB memory
 No Data: there is no data to output

▶ Press any key on the control panel to return to the Data Log Export screen.



<Right side of the display> [Fig. 6]

9. Remove the USB memory from the USB port.

Reference:

•A Log folder is created in the USB memory where the output file is saved in CSV format. The output file name will be displayed with the device ID, date and time of output, and data name. The date format can be changed in the settings (see page 63).

(Example) When the device is set to "A00001" and data from Jan. 1, 2019 - Oct. 1, 2019 is output using All:

	YY/MM/DD	DD/MM/YY
The oldest date of operation log - date of that day	A00001_20190101-20191001_DataLog.csv A00001_20190101-20191001_DoorLog.csv	A00001_01Jan2019-01Oct2019_DataLog.csv A00001_01Jan2019-01Oct2019_DoorLog.csv

(Example) When the device is set to "A00001" and the data from Jan. 1, 2019 is output using 24 Hours:

	YY/MM/DD	DD/MM/YY
Specified date	A00001_20190101_DataLog.csv A00001_20190101_DoorLog.csv	A00001_01Jan2019_DataLog.csv A00001_01Jan2019_DoorLog.csv

*If it is set to All. the outer door opening/closing history data file is output together.

*If the device ID is not set, the default setting "000000" will be displayed.

*If duplicate file names are used, the data that is output later will be overwritten.

10. Press the menu key (MENU/HOME) to display the home screen.

◇The display returns to the home screen automatically when 90 seconds has passed without any key operation.

OPERATION/ALARM LOG

Setting log interval

This product has a function for storing operation history data (internal temperature/CO₂ density/door opening and closing record). The log cycle (collection interval of operation history data) is set in the following way:

- Setting range: 2 minutes - 15 minutes
- Default setting (factory setting): 6 minutes (about 112 days of data saved)

1. On the home screen, press the menu key (MENU/HOME).
▶ The left side of the display will change to the Menu screen.



<Left side of the display> [Fig. 1]

2. Move the cursor on the Menu screen to Data Log [Fig. 1] using the up/down keys ($\Delta \nabla$), and press the enter key (ENTER).

▶ The display will change to the Data Log screen.

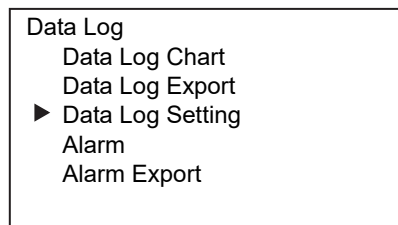

<Left side of the display> [Fig. 2]

3. Move the cursor on the Data Log screen to Data Log Setting [Fig. 2] using the up/down keys ($\Delta \nabla$), and press the enter key (ENTER).

▶ The display will change to the Data Log Setting screen [Fig. 3].

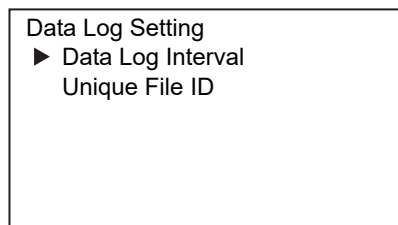

<Left side of the display> [Fig. 3]

4. With the cursor on Data Log Interval [Fig. 3], press the enter key (ENTER).

▶ The right side of the display will change to the Data Log Interval screen [Fig. 4].

5. Move the cursor using the left/right keys ($\triangleleft \triangleright$) and select the digit you want to change, and then use the up/down keys ($\Delta \nabla$) to change the number.

*If the entered setting value is out of the setting range, the following screen will be displayed on the right side of the display: Press any key on the control panel to change to the Data Log Interval screen [Fig. 4].

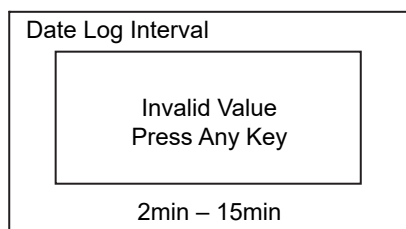

<Right side of the display>

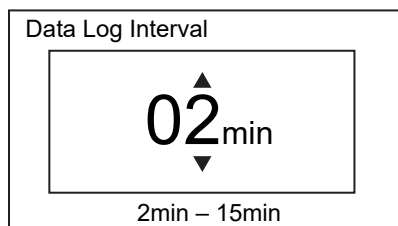

<Right side of the display> [Fig. 4]

6. Press the enter key (ENTER).

▶ The input value will be confirmed and you will be returned to the Log Setting screen.

7. Press the menu key (MENU/HOME) to display the home screen.

◇ The display returns to the home screen automatically when 90 seconds has passed without any key operation.

Note: Relation between log interval and the estimated amount of data that can be saved

Log interval=2 minutes: Approx. 48 days

Log interval=6 minutes: Approx. 112 days

Log interval=15 minutes: Approx. 168 days

When saving data more than the above, and the data is overwritten and the old data is deleted.

OPERATION/ALARM LOG

Setting Unique ID

You can set the unique device ID described in the file (CSV file) to be output to the USB memory.

- Setting range: 6 digits of alphanumeric characters (capital letters only if using letters)
- Default setting (factory setting): 000000

1. On the home screen, press the menu key (MENU/HOME).
▶ The left side of the display will change to the Menu screen.

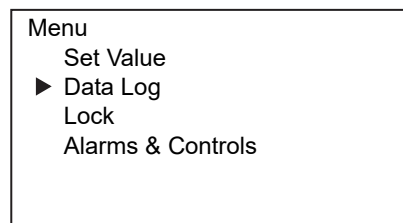

<Left side of the display> [Fig. 1]

2. Move the cursor on the Menu screen to Data Log [Fig. 1] using the up/down keys ($\Delta \nabla$), and press the enter key (ENTER).

▶ The display will change to the Data Log screen.

3. Move the cursor on the Data Log screen to Data Log Setting [Fig. 2] using the up/down keys ($\Delta \nabla$), and press the enter key (ENTER).

▶ The display will change to the Data Log Setting screen.

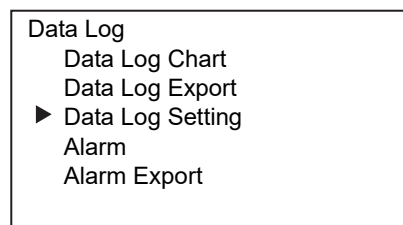

<Left side of the display> [Fig. 2]

4. Move the cursor on the Log Setting screen to Unique File ID [Fig. 3] using the up/down keys ($\Delta \nabla$), and press the enter key (ENTER).

▶ The right side of the display will change to the Unique File ID screen [Fig. 4].

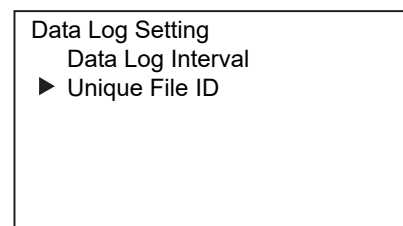

<Left side of the display> [Fig. 3]

5. Move the cursor using the left/right keys ($\triangleleft \triangleright$) and select the digit you want to change, and then use the up/down keys ($\Delta \nabla$) to change the number.

6. Press the enter key (ENTER).

▶ The input value will be confirmed and you will be returned to the Log Setting screen.

7. Press the menu key (MENU/HOME) to display the home screen.

◇ The display returns to the home screen automatically when 90 seconds has passed without any key operation.

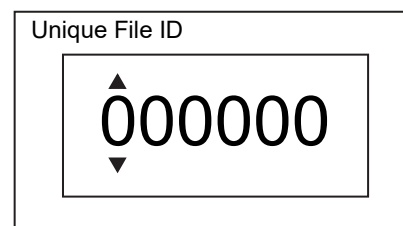

<Right side of the display> [Fig. 4]

OPERATION/ALARM LOG

Displaying alarm log

This product has a function for storing alarm history (maximum 256 cases). The alarm history stored in this product can be displayed on the display.

Note: When the alarm history goes over 257, they alarm history is deleted in order from the oldest cases.

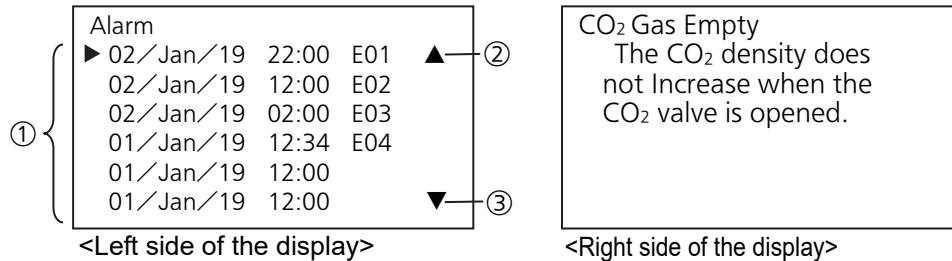

Alarm record display (left side of the display)

① Up to 6 alarm records can be displayed on the screen at once. The display shows the alarm occurrence date, time, and error code.

✧For details on error codes, see page 67.

② Scroll up mark

It is displayed when scroll up is possible.

✧When ▲ will be displayed, newer alarm history entries can be displayed with the up key (△).

③ Scroll down mark

It is displayed when scroll down is possible.

✧When ▼ will be displayed, older alarm history entries can be displayed with the down key (▽).

Error message display (right side of the display)

The error/alarm message that the cursor is pointing to will be displayed on the alarm record screen.

✧For error message details, see pages 67~68.

1. On the home screen, press the menu key (MENU/HOME).

▶ The left side of the display will change to the Menu screen.

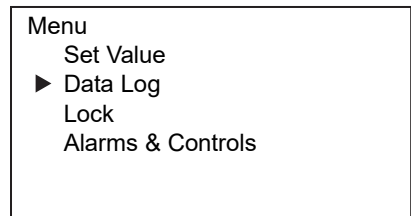

<Left side of the display> [Fig. 1]

2. Move the cursor on the Menu screen to Data Log [Fig. 1] using the up/down keys (△▽), and press the enter key (ENTER).

▶ The display will change to the Data Log screen.

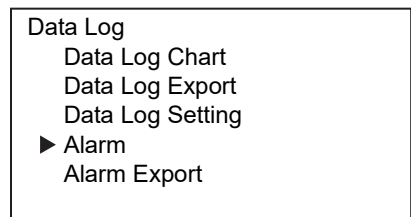

<Left side of the display> [Fig. 2]

3. Move the cursor on the Data Log screen to Alarm [Fig. 2] using the up/down keys (△▽), and press the enter key (ENTER).

▶ The display will change to the Alarm screen. [Fig. 3]

Left side of the display: Alarm record display

Right side of the display: error message display

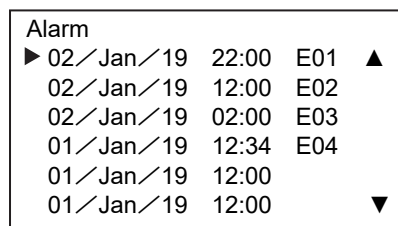

<Left side of the display>

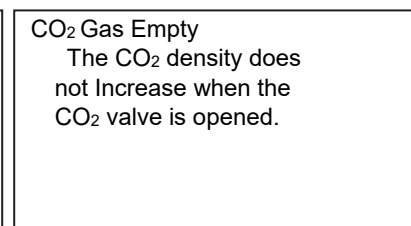

<Right side of the display> [Fig. 3]

4. Press the menu key (MENU/HOME) to display the home screen.

✧The display returns to the home screen automatically when 90 seconds has passed without any key operation.

OPERATION/ALARM LOG

Exporting alarm log

The alarm history data stored in this product can be output to a USB memory in a CSV format.

- Record output range: All, Specified date (1 day only)

1. Insert the USB memory into the USB port.

Note: It is not possible to use a USB memory with security functions that requires entering password.

2. On the home screen, press the menu key (MENU/HOME).

▶ The left side of the display will change to the Menu screen.

3. Move the cursor on the Menu screen to Data Log [Fig. 1] using the up/down keys (Δ / ∇), and press the enter key (ENTER).

▶ The display will change to the Data Log screen.

4. Move the cursor on the Data Log screen to Alarm Export [Fig. 2] using the up/down keys (Δ / ∇), and press the enter key (ENTER).

▶ The display will change to the Alarm Export screen [Fig. 3].

5. To output a record of a specific date, move the cursor to 24 Hours and press the enter key (ENTER).

▶ The right side of the display will change to the Date Select screen [Fig. 4].

6. Move the cursor using the left/right keys (\triangleleft / \triangleright) and select the digit you want to change, and then use the up/down keys (Δ / ∇) to change the number.

7. Press the enter key (ENTER). A record from the set date is output to the USB memory

▶ While the data is being output, "Exporting" will be displayed on the right side of the display [Fig. 5].

*If the entered setting value is out of the setting range, the following screen will be displayed on the right side of the display: Press any key on the control panel to change to the Date Select screen [Fig. 4].

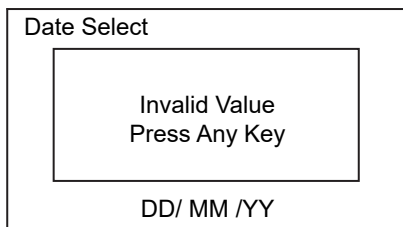

<Right side of the display>

*To output all saved records, select ALL in step 5 and press the enter key (ENTER).

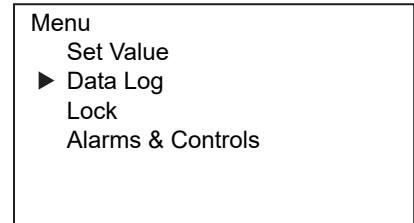

<Left side of the display> [Fig. 1]

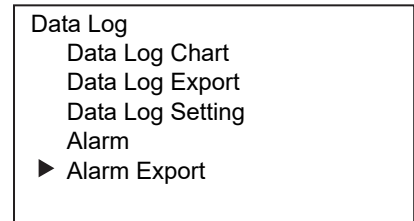

<Left side of the display> [Fig. 2]



<Left side of the display> [Fig. 3]

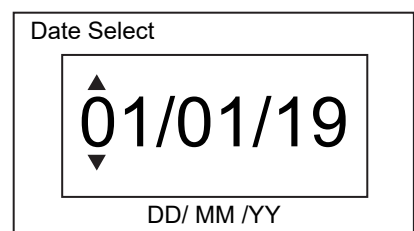

<Right side of the display> [Fig. 4]



<Right side of the display> [Fig. 5]

OPERATION/ALARM LOG

8. When outputting is complete, "Export complete" will be displayed [Fig. 6]. Press any key to return to the Alarm Export screen.

Note: Even after the export of operation log data is complete, operation log data saved in the incubator are not deleted.



<Right side of the display> [Fig. 6]

*The following messages may be displayed:

USB memory is disconnected: USB memory is not inserted

USB memory is full: there is no available space in the USB memory

An error occurred: failed to output to USB memory

No Data: there is no data to output

▶ Press any key on the control panel to return to the Alarm Export screen.

9. Remove the USB memory from the USB port.

Reference:

•A Log folder is created in the USB memory where the output file is saved in CSV format. The output file name will be displayed with the device ID, date and time of output, and data name. The date format can be changed in the settings (see page 63).

(Example) When the device is set to "A00001" and data from Jan. 1, 2019 - Oct. 1, 2019 is output using All:

	YY/MM/DD	DD/MM/YY
The oldest date of operation log - date of that day	A00001_20190101-20191001_AlarmLog.csv	A00001_01Jan2019-01Oct2019_AlarmLog.csv

(Example) When the device is set to "A00001" and the data from Jan. 1, 2019 is output using 24 Hours:

	YY/MM/DD	DD/MM/YY
Specified date	A00001_20190101_AlarmLog.csv	A00001_01Jan2019_AlarmLog.csv

*If the device ID is not set, the default setting "000000" will be displayed.

*If duplicate file names are used, the data that is output later will be overwritten.

10. Press the menu key (MENU/HOME) to display the home screen.

◇The display returns to the home screen automatically when 90 seconds has passed without any key operation.

KEY LOCK FUNCTION

Setting key lock

The settings can be locked to prevent them from being incorrectly changed. If setting lock is set to ON, the settings can not be changed even be operating the keys on the control panel.

- Setting values: ON or OFF
- Default setting (factory setting): OFF

1. On the home screen, press the menu key (MENU/HOME).
 - ▶ The left side of the display will change to the Menu screen.
2. Move the cursor on the Menu screen to Lock [Fig. 1] using the up/down keys ($\Delta \nabla$), and press the enter key (ENTER).
 - ▶ The display will change to the Lock screen [Fig. 2].
3. When the cursor on the lock screen is on Keypad Lock [Fig. 2], press the enter key (ENTER).
 - ▶ The left side of the display will change to the Keypad Lock ON/OFF setting screen, and the current setting value (OFF) will be displayed [Fig. 3].
4. Press the up/down keys ($\Delta \nabla$) to change it to ON.
 - ◇ Each time the up/down key is pressed the input value will change between ON and OFF.
5. Press the enter key (ENTER).
 - ▶ The Keypad Lock PW screen will be displayed [Fig. 4].
6. Use the left/right keys ($\triangleleft \triangleright$) to move the cursor around to the digit to be changed on the password (6 digits), use the up/down keys ($\Delta \nabla$) to set the numerical value, and press the enter key (ENTER).
 - ▶ The Confirm Password screen will be displayed [Fig. 5].
7. Use the left/right keys ($\triangleleft \triangleright$) to move the cursor around to the digit to be changed on the password (6 digits), use the up/down keys ($\Delta \nabla$) to set the numerical value, and press the enter key (ENTER).
 - ▶ You will be returned to the Lock screen and LOCK will be displayed on the upper right of the screen [Fig. 6].

*If the password does not match the initially entered password, the following screen will be displayed on the right side of the display. Pressing any of the directional keys ($\Delta \nabla \triangleleft \triangleright$) will return you to the Lock screen, so please rest from Step 3.

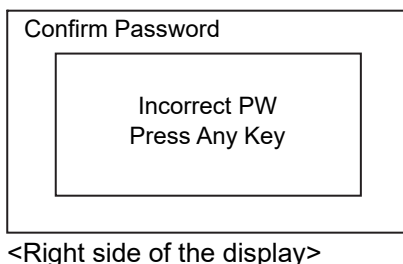

<Right side of the display>

Note: To prevent abuse of the release password of Keylock, manage properly by limited administrators.

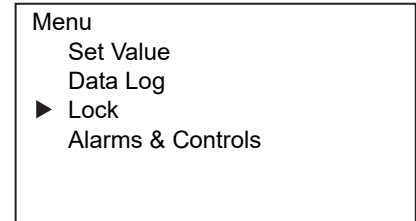

<Left side of the display> [Fig. 1]

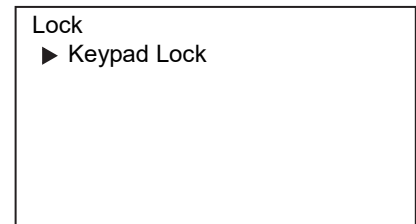

<Left side of the display> [Fig. 2]

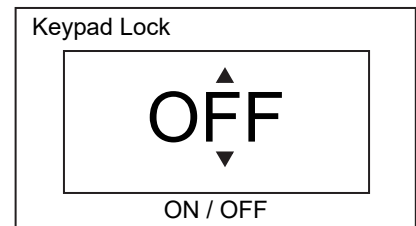

<Right side of the display> [Fig. 3]

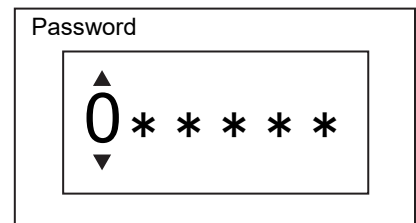

<Right side of the display> [Fig. 4]

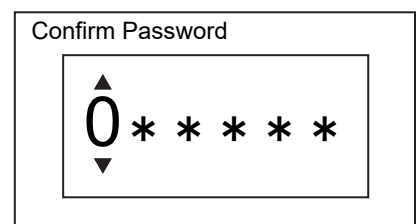

<Right side of the display> [Fig. 5]

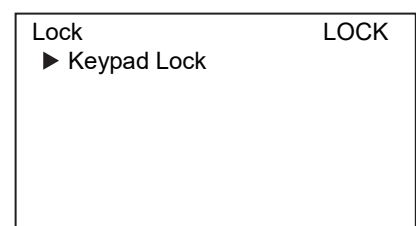

<Left side of the display> [Fig. 6]

KEY LOCK FUNCTION

8. Press the menu key (MENU/HOME) to display the home screen.

◇The display returns to the home screen automatically when 90 seconds has passed without any key operation.

Removing key lock

If the Key lock setting is OFF, it is possible to change the setting values.

1. On the home screen, press the menu key (MENU/HOME).

▶ The left side of the display will change to the Menu screen.

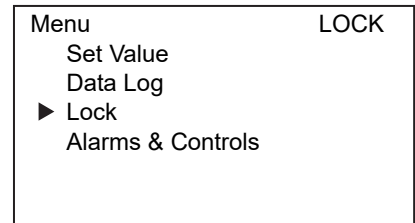

< Left side of the display> [Fig. 1]

2. Move the cursor on the Menu screen to Lock [Fig. 1] using the up/down keys (Δ ∇), and press the enter key (ENTER).

▶ The display will change to the Lock screen [Fig. 2].

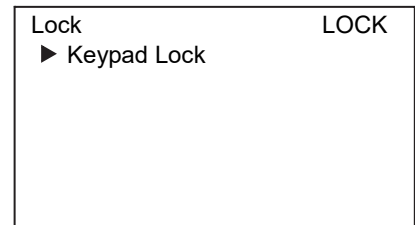

< Left side of the display> [Fig. 2]

3. When the cursor on the lock screen is on Keypad Lock [Fig. 2], press the enter key (ENTER).

▶ The right side of the display will change to the Keypad Lock ON/OFF setting screen and the current setting value will (ON) be displayed [Fig. 3].

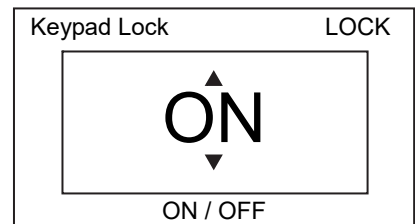

<Right side of the display> Fig. 3]

4. Press the up/down keys (Δ ∇) to change it to OFF.

◇Each time the up/down key is pressed, the value will change between OFF and ON.

5. Press the enter key (ENTER).

▶ The Confirm PW screen will be displayed [Fig. 4].

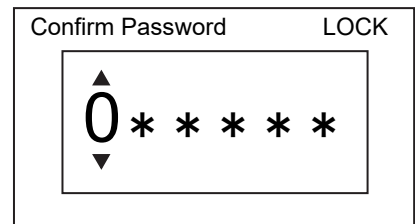

<Right side of the display> [Fig. 4]

6. Use the left/right keys (\triangleleft \triangleright) to move the cursor around to the digit to be changed on the password (6 digits), use the up/down keys (Δ ∇) to set the numerical value, and press the enter key (ENTER).

▶ You will be returned to the Lock screen, and the LOCK on the upper right of the display will disappear [Fig. 5].

Reference: The key lock unlock password will be erased.

*If the password does not match the password entered when turning on the key lock, the following screen will be displayed on the right of the display. Pressing any of the directional keys (Δ ∇ \triangleleft \triangleright) will return you to the Lock screen, so please rest from Step 3.

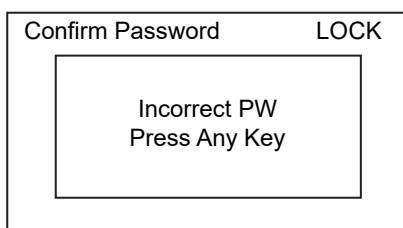

<Right side of the display>

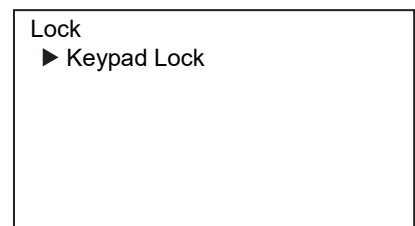

<Left side of the display> [Fig. 5]

7. Press the menu key (MENU/HOME) to display the home screen.

◇The display returns to the home screen automatically when 90 seconds has passed without any key operation.

ALARM PARAMETERS

Setting automatic set temperature alarm

When the chamber temperature exceeds the scope, the set temperature \pm the set value of Automatic set temperature alarm, the alarm is activated.

- Settable range: $\pm 1.0\text{ }^{\circ}\text{C} \sim \pm 5.0\text{ }^{\circ}\text{C}$
- Factory setting: $\pm 1.0\text{ }^{\circ}\text{C}$

1. On the home screen, press the menu key (MENU/HOME).
▶ The left side of the display will change to the Menu screen.
2. Move the cursor on the Menu screen to Alarms & Controls [Fig. 1] using the up/down keys ($\Delta \nabla$), and press the enter key (ENTER).
▶ The display will change to the Alarms & Controls screen.
3. When the cursor on the Alarms & Controls screen is on Temp/Gas Alarm Set [Fig. 2], press the enter key (ENTER).
▶ The display will change to the Temp/Gas Alarm Set screen.
4. When the cursor on the Temp/Gas Alarm Set screen is on Temp Alarm [Fig. 3], press the enter key (ENTER).
▶ The right side of the display will change to the Temp Alarm screen, and the current setting value (± 1.0) will be displayed [Fig. 4].
5. Move the cursor using the left/right keys ($\triangleleft \triangleright$) and select the digit you want to change, and then use the up/down keys ($\Delta \nabla$) to change the number.
6. Press the enter key (ENTER).
▶ The input value will be confirmed and you will be returned to the Temp/Gas Alarm Set screen.

*If the entered setting value is out of the setting range, the following screen will be displayed on the right side of the display: Press any of the keys on the control panel to change to the Temp Alarm screen [Fig. 4].

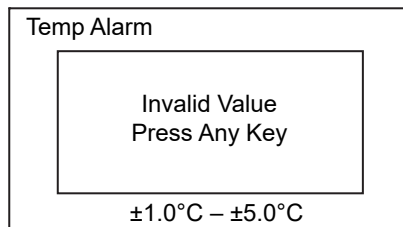

<Right side of the display>

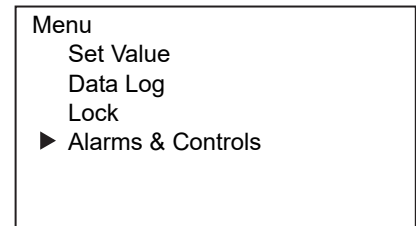

<Left side of the display> [Fig. 1]

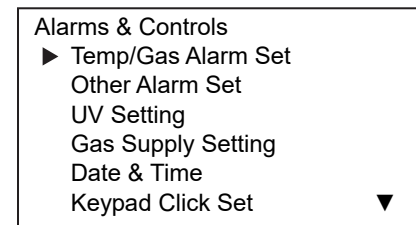

<Left side of the display> [Fig. 2]

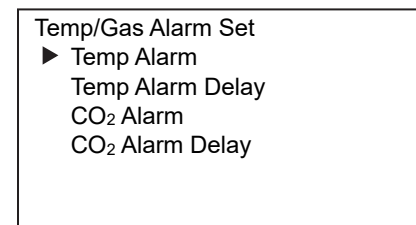

<Left side of the display> [Fig. 3]

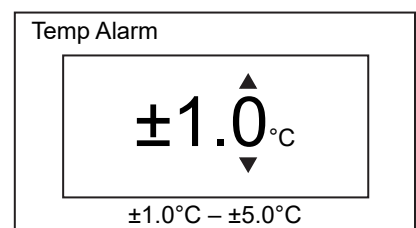

<Right side of the display> [Fig. 4]

7. Press the menu key (MENU/HOME) to display the home screen.
◇ The display returns to the home screen automatically when 90 seconds has passed without any key operation.

ALARM PARAMETERS

Setting automatic set temperature alarm delay

When the incubator is in the alarm state of Automatic set temperature the alarm buzzer will sound after the set time of alarm delay passed.

- Settable range: 0 minute~15 minutes
- Factory setting: 15 minutes.

1. On the home screen, press the menu key (MENU/HOME).
▶ The left side of the display will change to the Menu screen.

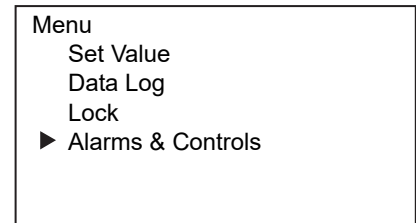

<Left side of the display> [Fig. 1]

2. Move the cursor on the Menu screen to Alarms & Controls [Fig. 1] using the up/down keys (Δ / ∇), and press the enter key (ENTER).
▶ The display will change to the Alarms & Controls screen.

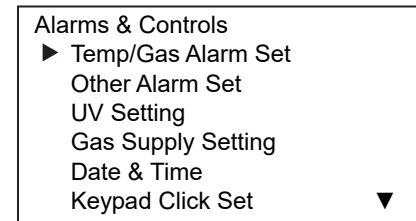

<Left side of the display> [Fig. 2]

3. When the cursor on the Alarms & Controls screen is on Temp/Gas Alarm Set [Fig. 2], press the enter key (ENTER).
▶ The display will change to the Temp/Gas Alarm Set screen.

4. Move the cursor on the Temp/Gas Alarm Set screen to Temp Alarm Delay [Fig. 3] using the up/down keys (Δ / ∇), and press the enter key (ENTER).
▶ The right side of the display will change to the Temp Alarm Delay screen, and the current setting value (15) will be displayed [Fig. 4].

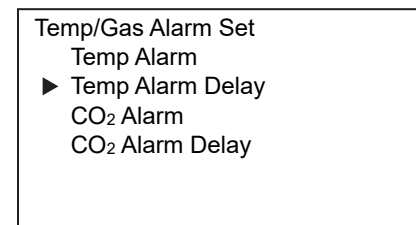

<Left side of the display> [Fig. 3]

5. Move the cursor using the left/right keys (\triangleleft / \triangleright) and select the digit you want to change, and then use the up/down keys (Δ / ∇) to change the number.

6. Press the enter key (ENTER).
▶ The input value will be confirmed and you will be returned to the Temp/Gas Alarm Set screen.

*If the entered setting value is out of the setting range, the following screen will be displayed on the right side of the display: Press any of the keys on the control panel to change to the Temp Alarm Delay screen [Fig. 4].

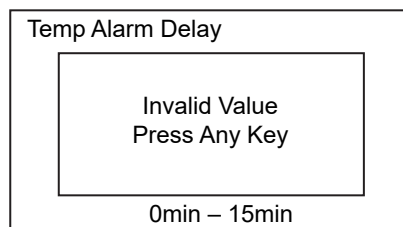

<Right side of the display>

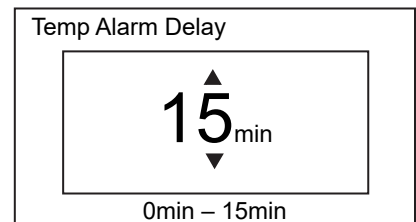

<Right side of the display> [Fig. 4]

7. Press the menu key (MENU/HOME) to display the home screen.

◇The display returns to the home screen automatically when 90 seconds has passed without any key operation.

Note: When the incubator is recovered from the alarm state within the set time of alarm delay, the buzzer doesn't sound after the elapse of the set time of alarm delay.

ALARM PARAMETERS

Setting automatic set CO₂ density alarm

When the chamber CO₂ density exceeds the scope, the set CO₂ density \pm the set value of Automatic set CO₂ density alarm, the alarm is activated.

- Settable range: $\pm 0.5\%$ ~ $\pm 5.0\%$
- Factory setting: $\pm 1.0\%$

1. On the home screen, press the menu key (MENU/HOME).
▶ The left side of the display will change to the Menu screen.

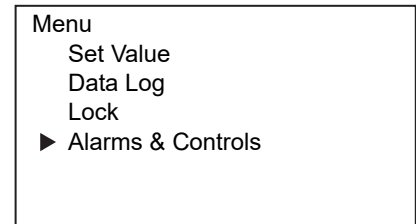

<Left side of the display> [Fig. 1]

2. Move the cursor on the Menu screen to Alarms & Controls [Fig. 1] using the up/down keys (Δ / ∇), and press the enter key (ENTER).
▶ The display will change to the Alarms & Controls screen.

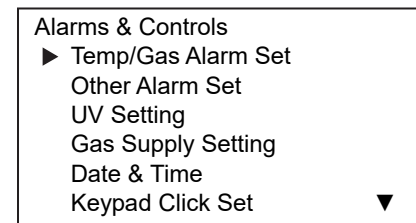

<Left side of the display> [Fig. 2]

3. When the cursor on the Alarms & Controls screen is on Temp/Gas Alarm Set [Fig. 2], press the enter key (ENTER).
▶ The display will change to the Temp/Gas Alarm Set screen.

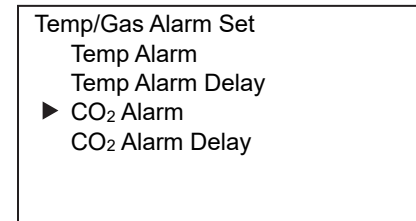

<Left side of the display> [Fig. 3]

4. Move the cursor on the Temp/Gas Alarm Set screen to CO₂ Alarm [Fig. 3] using the up/down keys (Δ / ∇), and press the enter key (ENTER).
▶ The right side of the display will change to the CO₂ Alarm screen, and the current setting value (± 1.0) will be displayed [Fig. 4].

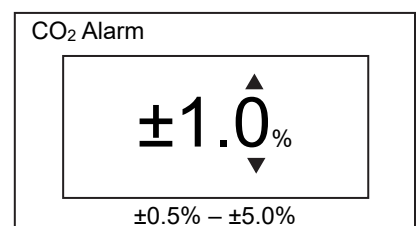

<Right side of the display> [Fig. 4]

5. Move the cursor using the left/right keys (\triangleleft / \triangleright) and select the digit you want to change, and then use the up/down keys (Δ / ∇) to change the number.

6. Press the enter key (ENTER).
▶ The input value will be confirmed and you will be returned to the Temp/Gas Alarm Set screen.

*If the entered setting value is out of the setting range, the following screen will be displayed on the right side of the display: Press any key on the control panel to change to the CO₂ Alarm screen [Fig. 4].

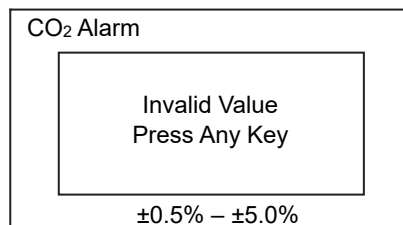

<Right side of the display>

7. Press the menu key (MENU/HOME) to display the home screen.

◇ The display returns to the home screen automatically when 90 seconds has passed without any key operation.

ALARM PARAMETERS

Setting automatic set CO₂ density alarm delay

When the incubator is in the alarm state of Automatic set CO₂ density, the alarm buzzer will sound after the set time of alarm delay passed.

- Settable range: 0 minute~15 minutes
- Factory setting: 15 minutes.

1. On the home screen, press the menu key (MENU/HOME).
▶ The left side of the display will change to the Menu screen.
2. Move the cursor on the Menu screen to Alarms & Controls [Fig. 1] using the up/down keys (△▽), and press the enter key (ENTER).
▶ The display will change to the Alarms & Controls screen.
3. When the cursor on the Alarms & Controls screen is on Temp/Gas Alarm Set [Fig. 2], press the enter key (ENTER).
▶ The display will change to the Temp/Gas Alarm Set screen.
4. Move the cursor on the Temp/Gas Alarm Set screen to CO₂ Alarm Delay [Fig. 3], and press the enter key (ENTER).
▶ The right side of the display will change to the CO₂ Alarm Delay screen, and the current setting value (15) will be displayed [Fig. 4].

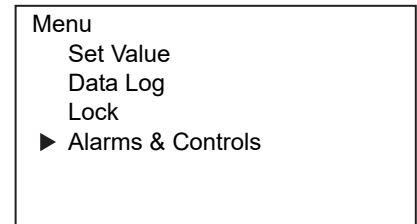

<Left side of the display> [Fig. 1]

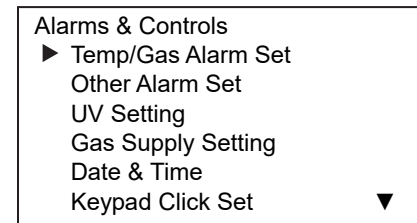

<Left side of the display> [Fig. 2]

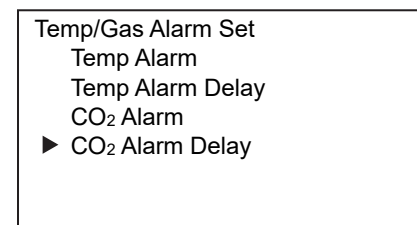

<Left side of the display> [Fig. 3]

5. Move the cursor using the left/right keys (◀▶) and select the digit you want to change, and then use the up/down keys (△▽) to change the number.

6. Press the enter key (ENTER).
▶ The input value will be confirmed and you will be returned to the Temp/Gas Alarm Set screen.

*If the entered setting value is out of the setting range, the following screen will be displayed on the right side of the display: Press any key on the control panel to change to the CO₂ Alarm Delay screen [Fig. 4].

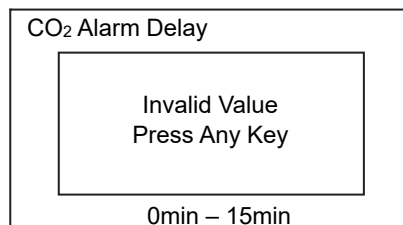

<Right side of the display>

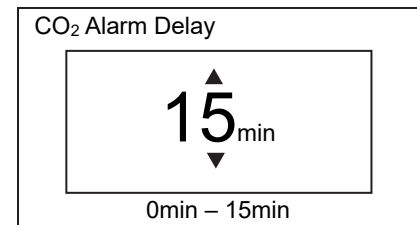

<Right side of the display> [Fig. 4]

7. Press the menu key (MENU/HOME) to display the home screen.
◇The display returns to the home screen automatically when 90 seconds has passed without any key operation.

Note: When the incubator is recovered from the alarm state within the set time of alarm delay, the buzzer doesn't sound after the elapse of the set time of alarm delay.

ALARM PARAMETERS

Setting door alarm delay

When the incubator is in the alarm state of door, the alarm buzzer will sound after the set time of door alarm delay passed.

- Settable range: 1 minute~30 minutes
- Factory setting: 2 minutes.

1. On the home screen, press the menu key (MENU/HOME).
▶ The left side of the display will change to the Menu screen.
2. Move the cursor on the Menu screen to Alarms & Controls [Fig. 1] using the up/down keys (Δ / ∇), and press the enter key (ENTER).
▶ The display will change to the Alarms & Controls screen.
3. Move the cursor on the Alarms & Controls screen to Other Alarm Set [Fig. 2] using the up/down keys (Δ / ∇), and press the enter key (ENTER).
▶ The display will change to the Other Alarm Set screen.
4. When the cursor on the Other Alarm Set screen is on Door Alarm Delay [Fig. 3], press the enter key (ENTER).
▶ The right side of the display will change to the Door Alarm Delay screen, and the current setting value (02) will be displayed [Fig. 4].
5. Move the cursor using the left/right keys (\triangleleft / \triangleright) and select the digit you want to change, and then use the up/down keys (Δ / ∇) to change the number.
6. Press the enter key (ENTER).
▶ The input value will be confirmed and you will be returned to the Other Alarm Set screen.

*If the entered setting value is out of the setting range, the following screen will be displayed on the right side of the display: Press any key on the control panel to change to the Door Alarm Delay screen [Fig. 4].

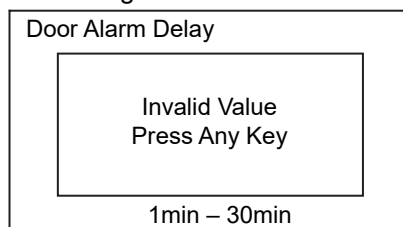

<Right side of the display>

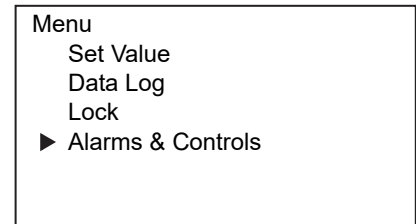

<Left side of the display> [Fig. 1]

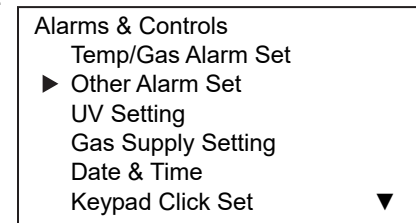

<Left side of the display> [Fig. 2]

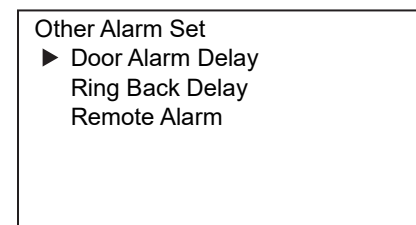

<Left side of the display> [Fig. 3]

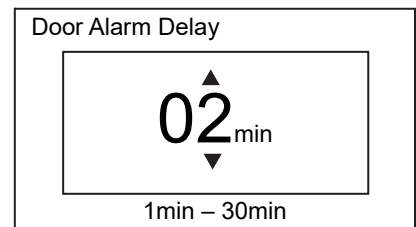

<Right side of the display> [Fig. 4]

7. Press the menu key (MENU/HOME) to display the home screen.
◇The display returns to the home screen automatically when 90 seconds has passed without any key operation.

Note: When the incubator is recovered from the alarm state within the set time of door alarm delay, the buzzer doesn't sound after the elapse of the set time of door alarm delay.

ALARM PARAMETERS

Setting ring back delay

The function is that the alarm buzzer sounds again when the alarm state still continues after the set time of ring back passed even though the alarm buzzer was stopped by pressing the BUZZER STOP key.

- Settable range: 0 minute~99 minutes
- Factory setting: 30 minutes

1. On the home screen, press the menu key (MENU/HOME).
▶ The left side of the display will change to the Menu screen.

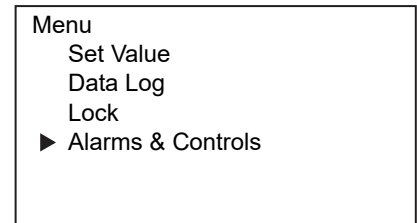

<Left side of the display> [Fig. 1]

2. Move the cursor on the Menu screen to Alarms & Controls [Fig. 1] using the up/down keys (Δ ∇), and press the enter key (ENTER).
▶ The display will change to the Alarms & Controls screen.

3. Move the cursor on the Alarms & Controls screen to Other Alarm Set [Fig. 2] using the up/down keys (Δ ∇), and press the enter key (ENTER).
▶ The display will change to the Other Alarm Set screen.

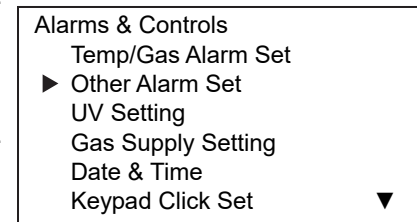

<Left side of the display> [Fig. 2]

4. Move the cursor on the Other Alarm Set screen to Ring Back Delay [Fig. 3] using the up/down keys (Δ ∇), and press the enter key (ENTER).
▶ The right side of the display will change to the Ring Back Delay screen, and the current setting value (30) will be displayed [Fig. 4].

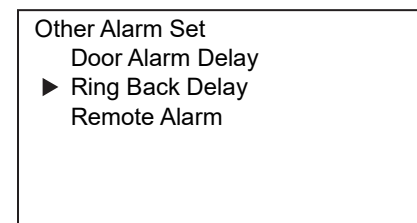

<Left side of the display> [Fig. 3]

5. Move the cursor using the left/right keys (\triangleleft \triangleright) and select the digit you want to change, and then use the up/down keys (Δ ∇) to change the number.

6. Press the enter key (ENTER).
▶ The input value will be confirmed and you will be returned to the Other Alarm Set screen.

*If the entered setting value is out of the setting range, the following screen will be displayed on the right side of the display: Press any key on the control panel to change to the Ring Back Delay screen [Fig. 4].

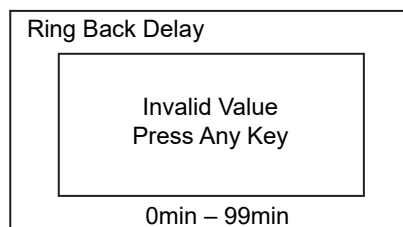

<Right side of the display>

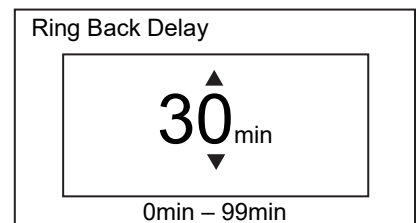

<Right side of the display> [Fig. 4]

7. Press the menu key (MENU/HOME) to display the home screen.

◇The display returns to the home screen automatically when 90 seconds has passed without any key operation.

Note: In the case of Err01 (CO₂ gas cylinder empty), Err11 (CO₂ sensor error) or Door alarm, the alarm is not re-activated because the alarm itself is canceled by pressing the BUZZER STOP key. Incidentally in the case of Err18 (UV lamp failure), the alarm is not re-activated if the BUZZER STOP key is pressed after the UV lamp ON period elapses (refer to page 67~68).

ALARM PARAMETERS

Setting remote alarm

The function is that the remote alarm is continued even though the buzzer is stopped by pressing the BUZZER STOP key.

If it is set to ON (not linked): even if the alarm BUZZER STOP key is pressed when the alarm buzzer is activated, the alarm on the remote alarm device will not be stopped.

If it is set to OFF (linked): If the alarm BUZZER STOP key is pressed when the alarm buzzer is activated, the alarm on the remote alarm device will not be stopped.

- Setting value: ON (not linked) or OFF (linked)
- Default setting (factory setting): ON

1. On the home screen, press the menu key (MENU/HOME).
▶ The left side of the display will change to the Menu screen.

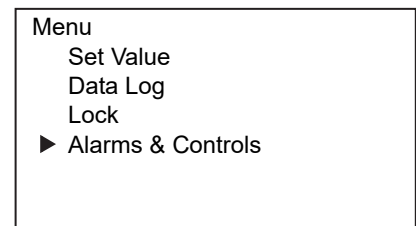

<Left side of the display> [Fig. 1]

2. Move the cursor on the Menu screen to Alarms & Controls [Fig. 1] using the up/down keys (Δ ∇), and press the enter key (ENTER).
▶ The display will change to the Alarms & Controls screen.

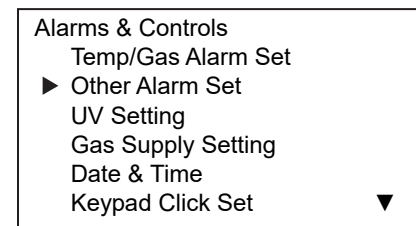

<Left side of the display> [Fig. 2]

3. Move the cursor on the Alarms & Controls screen to Other Alarm Set [Fig. 2] using the up/down keys (Δ ∇), and press the enter key (ENTER).
▶ The display will change to the Other Alarm Set screen.

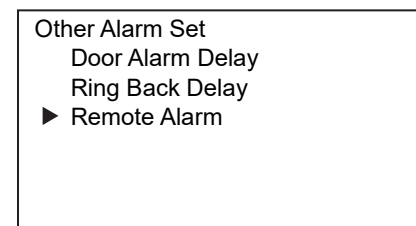

<Left side of the display> [Fig. 3]

4. Move the cursor on the Other Alarm Set screen to Remote Alarm [Fig. 3] using the up/down keys (Δ ∇), and press the enter key (ENTER).
▶ The right side of the display will change to the Remote Alarm screen, and the current setting value (ON) will be displayed [Fig. 4].

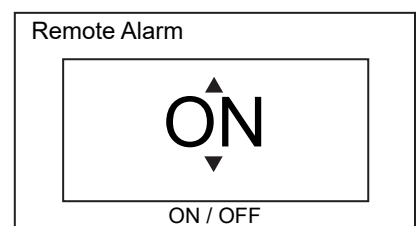

<Right side of the display> [Fig. 4]

5. Use the up/down keys (Δ ∇) to change the remote alarm setting value.
◇ Each time the up/down key is pressed the input value will change between ON and OFF.

6. Press the enter key (ENTER).
▶ The input value will be confirmed and you will be returned to the Other Alarm Set screen.

7. Press the menu key (MENU/HOME) to display the home screen.
◇ The display returns to the home screen automatically when 90 seconds has passed without any key operation.

UV LAMP (OPTION)

The UV lamp operates when the optional UV System MCO-170UVS is installed on the model MCO-170ACL.

Operation of the UV lamp disinfects the water in the humidifying pan and the air circulating in the chamber.

Using UV lamp

1. Correctly install all of the inner attachments, and place the cultivation samples on the trays.

Note:

- The humidifying pan and humidifying pan cover prevent UV light from leaking. Always use them even when not humidifying.
- Never turn ON the UV lamp when the humidifying pan cover is removed.
- Always use the humidifying pan cover even when using the incubator without turning ON the UV lamp. Using without humidifying pan cover may have a bad influence on the chamber temperature distribution and humidity recovery.

2. Close the outer door. The UV lamp will light for the preset period (i.e. the time set on “UV Timer” plus the time added by “UV Timer Ext”). Refer to page 58 for instructions on setting the timer.

Notes:

- If the outer door is opened while the UV lamp is lit, the lamp will turn OFF. When the door is closed again, the lamp will light for the preset period.
- Repeated opening and closing of the outer door may adversely affect the condensation in the chamber and the chamber temperature distribution because the UV lamp generates heat for a long time. It may also shorten the service life of the UV lamp.
- UV light is harmful to the eyes. Do not turn the UV lamp ON when the inner door is open.

3. If the outer door is not opened for at least 12 consecutive hours, the UV lamp lights for the preset period every 12 hours.

Note: Opening the outer door will reset the 12-hour period.

- The recommended replacement time for the UV lamp (i.e., when the UV output ratio drops to 60 %–70 % of its initial value) is when the accumulated ON time reaches 5,000 hours. The message “Warning: UV Bulb Life” then appears in the message display field. Replace the UV lamp promptly at this point. Contact our sales representative or agent for information.

- If the UV lamp burns out, “Err18: UV Lamp Abnormal” is displayed in the message display field. Replace the UV lamp, and replace the glow starter (type FG-7P or FG-7PL) at the same time. Contact our sales representative or agent for information.

UV LAMP (OPTION)

Setting UV lamp ON period

To change the UV lamp lighting times, follow the procedure below.

- Lighting time setting range: 0 - 30 minutes
- Default setting (factory setting): 10 minutes

Note:

- The recommended UV lighting time (UV TIMER) is 10 minutes. Less than 10 minutes may have an insufficient bactericidal effect.
- If it is set to 0 minutes, the UV lamp will not light up.

1. On the home screen, press the menu key (MENU/HOME).
▶ The left side of the display will change to the Menu screen.

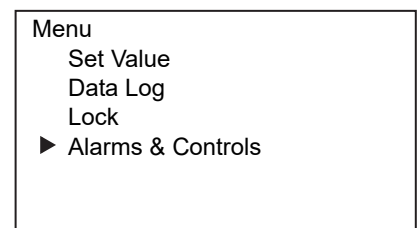

<Left side of the display> [Fig. 1]

2. Move the cursor on the Menu screen to Alarms & Controls [Fig. 1] using the up/down keys (Δ / ∇), and press the enter key (ENTER).
▶ The display will change to the Alarms & Controls screen.

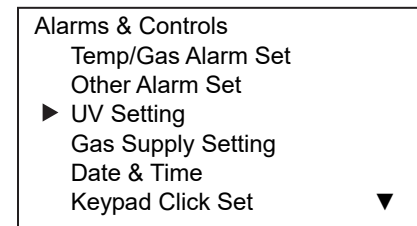

<Left side of the display> [Fig. 2]

3. Move the cursor on the Alarms and Controls screen to UV Setting [Fig. 2] using the up/down keys (Δ / ∇), and press the enter key (ENTER).
▶ The display will change to the UV Setting screen.

4. With the cursor on the UV Setting screen on Lighting Time [Fig. 3], press the enter key (ENTER).
▶ The right of the display will change to the UV Lighting Time screen, and the current setting value (10) will be displayed [Fig. 4].

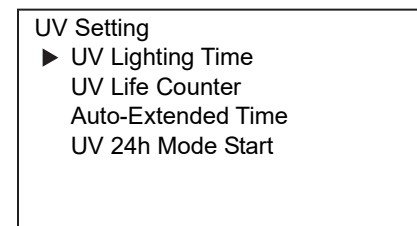

<Left side of the display> [Fig. 3]

5. Move the cursor using the left/right keys (\triangleleft / \triangleright) and select the digit you want to change, and then use the up/down keys (Δ / ∇) to change the number.

6. Press the enter key (ENTER).
▶ The input value will be confirmed and you will be returned to the UV Setting screen.

*If the entered setting value is out of the setting range, the following screen will be displayed on the right side of the display: Press any key on the control panel to return to the UV Lighting Time screen [Fig. 4].

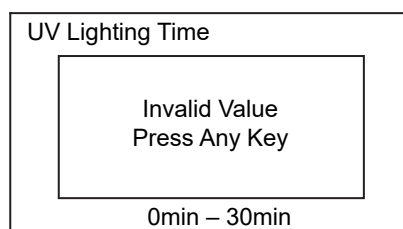

<Right side of the display>

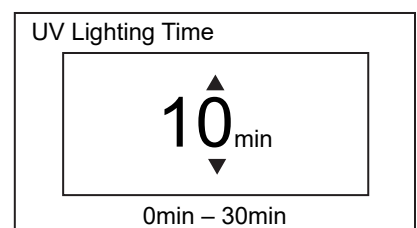

<Right side of the display> [Fig. 4]

7. Press the menu key (MENU/HOME) to display the home screen.

◇ The display returns to the home screen automatically when 90 seconds has passed without any key operation.

UV LAMP (OPTION)

UV lamp life indication

For the recommended time of 5,000 cumulative hours before UV lamp replacement, the current accumulated time (%) will be displayed (can not be set).

1. On the home screen, press the menu key (MENU/HOME).
▶ The left side of the display will change to the Menu screen.
2. Move the cursor on the Menu screen to Alarms & Controls [Fig. 1] using the up/down keys (Δ / ∇), and press the enter key (ENTER).
▶ The display will change to the Alarms & Controls screen.
3. Move the cursor on the Alarms and Controls screen to UV Setting [Fig. 2] using the up/down keys (Δ / ∇), and press the enter key (ENTER).
▶ The display will change to the UV Setting screen.
4. Move the cursor on the UV Setting screen to UV Life Counter [Fig. 3] using the up/down keys (Δ / ∇), and press the enter key (ENTER).
▶ The right side of the display will change to the UV Life Counter screen, and the current cumulative UV lighting time will be displayed [Fig. 4].
5. Press the enter key (ENTER).
▶ You will be returned to the UV Setting screen.
6. Press the menu key (MENU/HOME) to display the home screen.
◇ The display returns to the home screen automatically when 90 seconds has passed without any key operation.

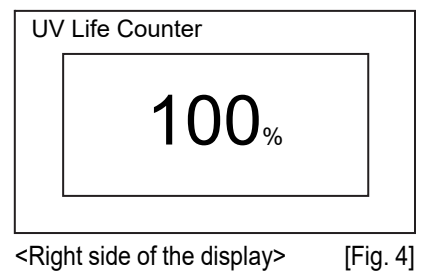
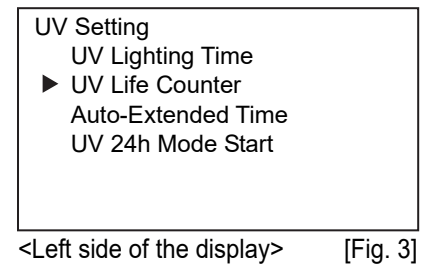
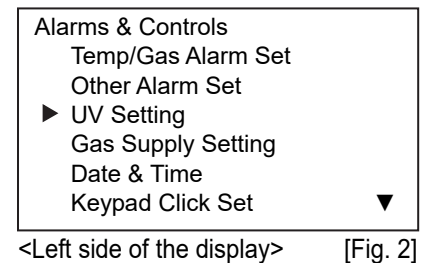
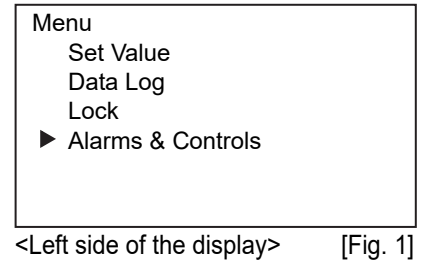

UV LAMP (OPTION)

Setting UV timer extension

UV output decreases as the cumulative time that the UV lamp is turned on increases. To compensate for this, the time to turn on the UV lamp on this product is automatically extended as the accumulated time that the UV lamp has been on increases.

- Extension rate: 0% - 40% (can not be set)

Example) UV Timer: 10 minutes, UV Timer Ext.: 10 % → UV lamp lights for 11 minutes.

1. On the home screen, press the menu key (MENU/HOME).
▶ The left side of the display will change to the Menu screen.
2. Move the cursor on the Menu screen to Alarms & Controls [Fig. 1] using the up/down keys (Δ / ∇), and press the enter key (ENTER).
▶ The display will change to the Alarms & Controls screen.
3. Move the cursor on the Alarms and Controls screen to UV Setting [Fig. 2] using the up/down keys (Δ / ∇), and press the enter key (ENTER).
▶ The display will change to the UV Setting screen.
4. Move the cursor on the UV Setting screen to Auto-Extended Time (Fig. 3) using the up/down keys (Δ / ∇), and press the enter key (ENTER).
▶ The right side of the display will change to the Auto-Extended Time screen, and the current UV lighting time's automatic extension ratio will be displayed [Fig. 4].
5. Press the enter key (ENTER).
▶ You will be returned to the UV Setting screen.
6. Press the menu key (MENU/HOME) to display the home screen.
◇The display returns to the home screen automatically when 90 seconds has passed without any key operation.

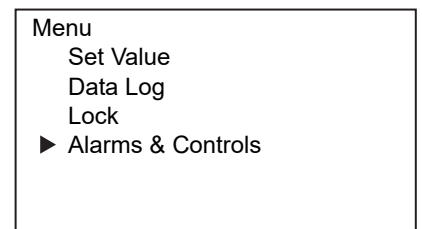

<Left side of the display> [Fig. 1]

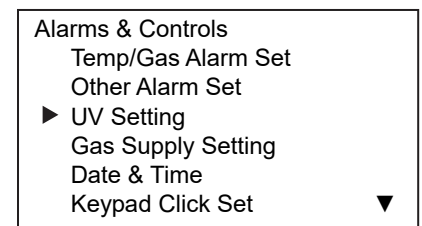

<Left side of the display> [Fig. 2]

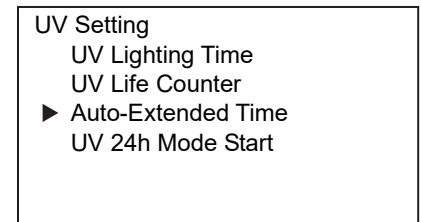

<Left side of the display> [Fig. 3]

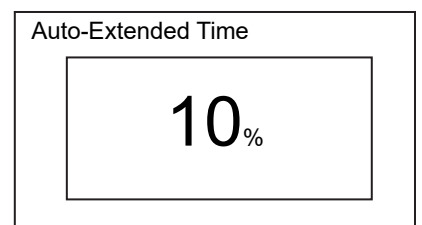

<Right side of the display> [Fig. 4]

UV LAMP (OPTION)

Lighting UV lamp for 24 hours

If contamination occurs inside the container due to accumulation of dirt or the culture medium being scattered etc., please sterilize it with 24-hour continuous irradiation of the UV lamp as described in the following procedure:

- Setting values: ON or OFF
- Default setting (factory setting): OFF

1. Remove the internal items (racks, fan cover, duct, internal circulation fan, humidifying tray, and humidifying tray cover). Clean the internal items with autoclave sterilization or disinfecting alcohol and wipe off the contaminant.

2. Clean the interior with disinfecting alcohol, wipe off the contaminant and close the outer door.

3. Set the CO₂ density to 0% (see page 34).

4. On the home screen, press the menu key (MENU/HOME).
▶ The left side of the display will change to the Menu screen.

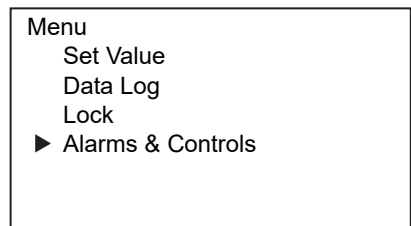

<Left side of the display> [Fig. 1]

5. Move the cursor on the Menu screen to Alarms & Controls [Fig. 1] using the up/down keys (Δ / ∇), and press the enter key (ENTER).
▶ The display will change to the Alarms & Controls screen.

6. Move the cursor on the Alarms and Controls screen to UV Setting [Fig. 2] using the up/down keys (Δ / ∇), and press the enter key (ENTER).
▶ The display will change to the UV Setting screen.

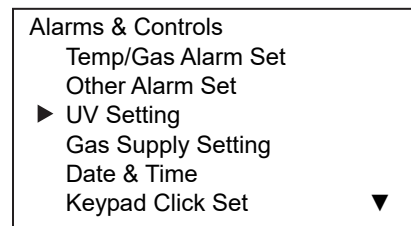

<Left side of the display> [Fig. 2]

7. Move the cursor on the UV Setting screen to UV 24h Mode Start [Fig. 3] using the up/down keys (Δ / ∇), and press the enter key (ENTER).
▶ The right side of the display will change to the UV 24h Mode Start setting screen, and the current setting value (OFF) will be displayed [Fig. 4].

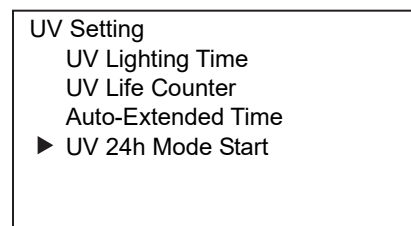

<Left side of the display> [Fig. 3]

8. Use the up/down keys (Δ / ∇) to change the UV 24h lighting mode setting value to ON.

◇ Each time the up/down key is pressed the input value will change between ON and OFF.

9. Press the enter key (ENTER).

▶ The input value will be confirmed, you will be returned to the UV Setting screen, and the UV 24 hour lighting mode will start.

Reference: When the UV lamp is lit. "UV:ON" will be displayed on the UV lamp status display.

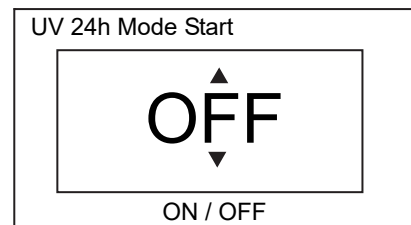

<Right side of the display> [Fig. 4]

10. Press the menu key (MENU/HOME) to display the home screen.

◇ The display returns to the home screen automatically when 90 seconds has passed without any key operation.

Note:

- The UV 24-hour mode may cause the automatic set temperature alarm because of a rising chamber temperature.
- After procedure 9, by opening the outer door when UV lamp is lighting, UV lamp is turned OFF and UV 24-hour mode is canceled by opening the outer door. Redo from procedure 4 to start the UV 24-hour mode again.

11. After 24 hours, the UV lamp turns off automatically and you can reinstall the removed interior items.

GAS AUTO CHANGER (OPTION)

When an optional gas auto changer MCO-21GC is installed, there are two connecting ports for CO₂ gas pipe, A and B. By connecting two CO₂ gas cylinders, this kit switches the CO₂ gas supply line when one of the CO₂ gas cylinders becomes empty.

Connecting CO₂ gas cylinder

1. Get two CO₂ gas cylinder ready (CO₂ gas cylinder A and B) and install an optional gas regulator MCO-010R in both of CO₂ gas cylinders.

Note:

- Use a liquefied CO₂ gas cylinder (at least 99.5 % pure). The siphon (dip tube) type cannot be used.
- When MCO-010R is not available, install a gas regulator rated at 25 MPa(G) (250 kgf/cm²(G), 3600 psi(G)) for the primary side, and 0.25 MPa(G) (2.5 kgf/cm²(G), 36 psi(G)) for the secondary side.

2. Using a gas tube that is provided, connect the connecting port A for CO₂ gas pipe and the gas regulator of the CO₂ gas cylinder A.

3. Using a gas tube that is provided, connect the connecting port B for CO₂ gas pipe and the gas regulator of the CO₂ gas cylinder B.

Note: If the CO₂ gas is supplied to multiple CO₂ incubators from a single gas cylinder, a CO₂ solid will be formed in the gas regulator. The gas regulator safety valve will operate, and it may make an explosive sound.

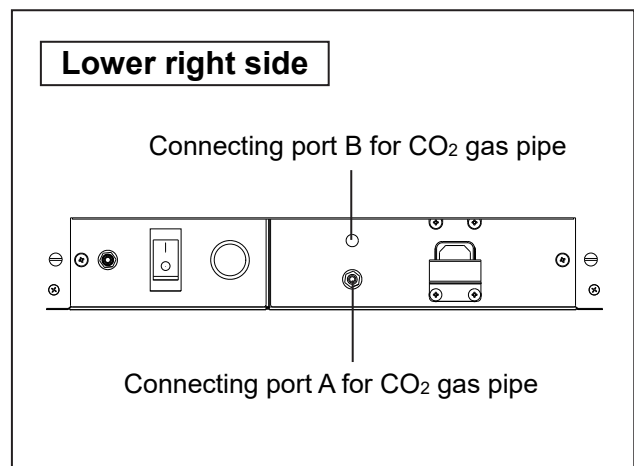

4. After connecting the gas tube, make sure that no gas is leaking (ex. by using a gas leak detection spray).

5. Both CO₂ gas cylinder A and B, adjust the secondary side pressure of the gas regulator to 0.03MPa(G)~0.1 MPa(G) (0.3 kgf/cm²(G)~1 kgf/cm²(G), 4.4 psi(G)~14.5 psi(G)) while CO₂ gas is injecting. Recommended pressure: 0.03 MPa (0.3 kgf/cm²(G), 4.4 psi(G)).

Note:

- As the pressure increases, the CO₂ gas density control range will increase. Excessive pressure may cause gas supply lines inside the incubator to come loose, which may result in gas poisoning or oxygen deprivation due to the escaping of gas. If gas lines come loose, the incubator must be repaired.
- Close the valve of the CO₂ gas cylinder when the CO₂ gas is not in use.

Automatic CO₂ gas supply line changeover

When an optional gas auto changer MCO-21GC is installed, CO₂ gas supply line indicator A and B and the CO₂ gas supply line select key are displayed in the Top screen. The CO₂ gas supply line indicator A or B used now lights.

CO₂ gas supply line indicator A and B (CO₂ gas supply line which is used now)

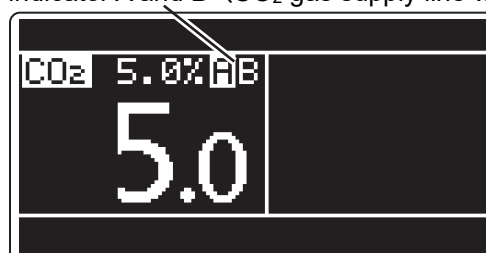











<Right side of the display>

GAS AUTO CHANGER (OPTION)

When the CO₂ density level remains unchanged, even though the CO₂ gas valve in the unit is opened, the unit regards the present connecting CO₂ gas cylinder as an empty. The CO₂ gas supply line is changed over automatically. The behavior in that case is shown in Table. 2.

1. When there is gas remaining in cylinder A, the unit operates with gas supplied from cylinder A (Situation 1).
2. When cylinder A is empty, the level of CO₂ density in the unit does not increase because gas is not supplied into the unit even though the gas valve in the unit is open (Situation 2).
3. When Situation 2 continues for 2–3 minutes, the gas supply line is changed over automatically. The CO₂ gas empty alarm is activated sounding the buzzer, and gas supply indicator A is displayed in reverse video and blinks (Situation 3).
4. Stop the CO₂ gas empty alarm by pressing BUZZER STOP key. The light on gas supply indicator A is turned off (Situation 4).
5. Exchange the empty gas cylinder A for a new one immediately (Situation 5).
6. When cylinder B is empty, the supply reverts to cylinder A.

Table 2 CO₂ gas supply line automatic changeover

Situation	CO ₂ gas			CO ₂ gas supply line indicator		Message display field
	Supply line	Cylinder A	Cylinder B	A	B	
1 CO ₂ gas is supplying from valve A.	A	Remaining	Remaining	 Reverse video and light on	 Light on	-----
2 CO ₂ density in the chamber is not increased even if CO ₂ gas valve opens.	A	Empty	Remaining	 Reverse video and light on	 Light on	-----
3 CO ₂ gas supply line is changed over B automatically.	B	Empty	Remaining	 Blink	 Reverse video and light on	Err01: CO ₂ Gas Empty (and buzzer)
4 Pressed the BUZZER STOP key.	B	Empty	Remaining	 Light on	 Reverse video and light on	-----
5 Changed empty gas cylinder A into a new one.	B	Remaining	Remaining	 Light on	 Reverse video and light on	-----

Note:

- When the BUZZER STOP key is not pressed in Situation 4 and cylinder B becomes empty before cylinder A is replaced, the supply will switch back to cylinder A. In this case, replace both cylinders and press BUZZER STOP key immediately.
- The automatic changeover of cylinders is linked to the CO₂ density in the chamber. The automatic changeover of cylinders may also occur in the situations where, e.g. the gas tube gets clogged, gas is leaking, the gas pressure has dropped, the valve on the gas cylinder is insufficiently open etc, even though the cylinder being used is not completely empty.

GAS AUTO CHANGER (OPTION)

Manual CO₂ gas supply line A/B changeover

The CO₂ gas supply lines A and B can be switched manually at any time.

- Setting values: A or B
- Default setting (factory setting): A

1. On the home screen, press the menu key (MENU/HOME).
 - ▶ The left side of the display will change to the Menu screen.
2. Move the cursor on the Menu screen to Alarms & Controls [Fig. 1] using the up/down keys (△▽), and press the enter key (ENTER).
 - ▶ The display will change to the Alarms & Controls screen.
3. Move the cursor on the Alarms & Controls screen to Gas Supply Setting [Fig. 2] using the up/down key (△▽), and press the enter key (ENTER).
 - ▶ The display will change to the Gas Supply Setting screen.
4. With the cursor on the Gas Supply Setting screen on CO₂ Supply [Fig. 3], press the enter key (ENTER).
 - ▶ The right side of the display will change to the CO₂ Supply setting screen, and the current setting value (A) will be displayed [Fig. 4].
5. Use the up/down keys (△▽) to change the CO₂ gas supply setting values.
 - ◇ Each time the up/down key is pressed the input value will change between A and B.
6. Press the enter key (ENTER).
 - ▶ The input value will be confirmed and you will be returned to the Gas Supply Setting screen.
7. Press the menu key (MENU/HOME) to display the home screen.
 - ◇ The display returns to the home screen automatically when 90 seconds has passed without any key operation.

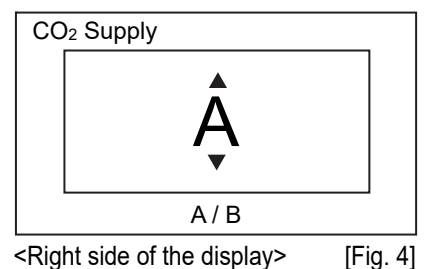
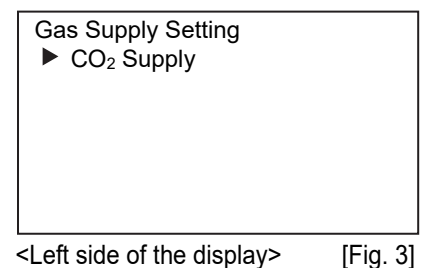
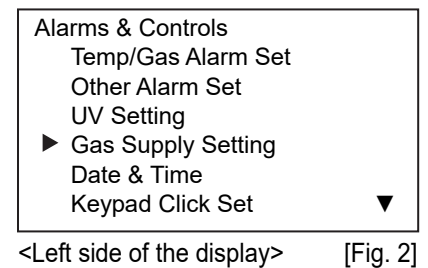
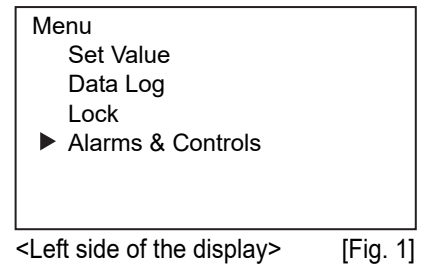

Note: Table 3 shows the actions for when the CO₂ gas supply line is switched using the CO₂ gas automatic switching function and then manually switched back to the empty CO₂ gas supply line before pressing BUZZER STOP key.

Table 3. Manual change from cylinder B to empty cylinder A

	Situation	CO ₂ gas			CO ₂ gas supply line indicator		Message display field
		Supply line	Cylinder A	Cylinder B	A	B	
1	Changed into CO ₂ gas supply line B automatically.	B	Empty	Remaining	Blink	Reverse video and Light on	Err01: CO ₂ Gas Empty (and buzzer)
2	Not press the BUZZER STOP key, CO ₂ gas supply line was switched.	A	Empty	Remaining	Reverse video and blink	Light on	Err01: CO ₂ Gas Empty (and buzzer)

OTHER PARAMETERS

Setting date display (format)

Set the display format for the dates with the following procedure:

- Setting values: DD/MM/YY (Day/Month/Year), YY/MM/DD (Year/Month/Day)
- Default setting (factory setting): DD/MM/YY

1. On the home screen, press the menu key (MENU/HOME).
▶ The left side of the display will change to the Menu screen.

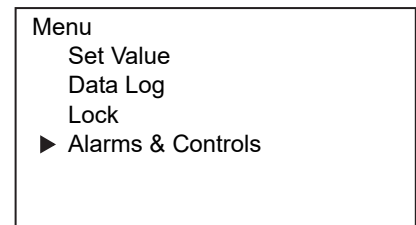

<Left side of the display> [Fig. 1]

2. Move the cursor on the Menu screen to Alarms & Controls [Fig. 1] using the up/down keys (Δ / ∇), and press the enter key (ENTER).
▶ The display will change to the Alarms & Controls screen.

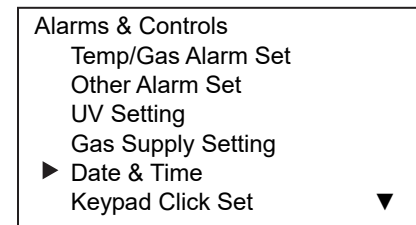

<Left side of the display> [Fig. 2]

3. Move the cursor on the Alarms & Controls screen to Date & Time [Fig. 2] using the up/down keys (Δ / ∇), and press the enter key (ENTER).
▶ The display will change to the Date & Time screen.

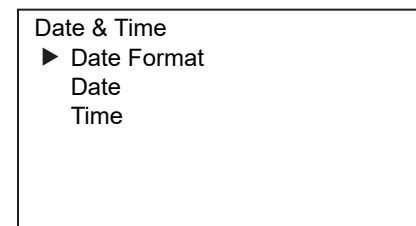

<Left side of the display> [Fig. 3]

4. With the cursor on the Date & Time screen on Date Format [Fig. 3], press the enter key (ENTER).
▶ The right side of the display will change to the Date Format screen, and the current setting value (DD/MM/YY) will be displayed [Fig. 4].

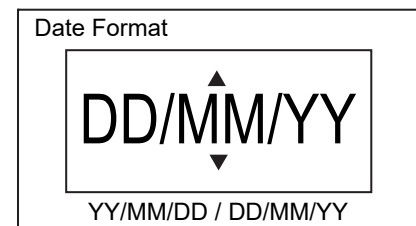

<Right side of the display> [Fig. 4]

5. Use the up/down keys (Δ / ∇) to change the date format setting values.

◇ Each time the up/down key is pressed the input value will change between YY/MM/DD and DD/MM/YY.

6. Press the enter key (ENTER).

▶ The input is confirmed and you will be returned to the Date & Time screen.

7. Press the menu key (MENU/HOME) to display the home screen.

◇ The display returns to the home screen automatically when 90 seconds has passed without any key operation.

OTHER PARAMETERS

Setting date

Change the date settings with the following procedure:

1. On the home screen, press the menu key (MENU/HOME).
▶ The left side of the display will change to the Menu screen.
2. Move the cursor on the Menu screen to Alarms & Controls [Fig. 1] using the up/down keys ($\Delta\nabla$), and press the enter key (ENTER).
▶ The display will change to the Alarms & Controls screen.
3. Move the cursor on the Alarms & Controls screen to Date & Time [Fig. 2] using the up/down keys ($\Delta\nabla$), and press the enter key (ENTER).
▶ The display will change to the Date & Time screen.
4. Move the cursor on the Date & Time screen to Date [Fig. 3] using the up/down keys ($\Delta\nabla$), and press the enter key (ENTER).
▶ The right side of the display will change to the Date screen, and the current date (Year/Month/Date) will be displayed [Fig. 4].
5. Move the cursor using the left/right keys ($\triangleleft\triangleright$) and select the digit you want to change, and then use the up/down keys ($\Delta\nabla$) to change the number.
Even when the date display format is DD/MM/YY, the numerical values can be changed in the same way.
6. Press the enter key (ENTER).
▶ The input is confirmed and you will be returned to the Date & Time screen.

*When the entered date is out of the setting range, the following screen will be displayed on the right side of the display: Press any key on the control panel to change to the Date screen [Fig. 4].

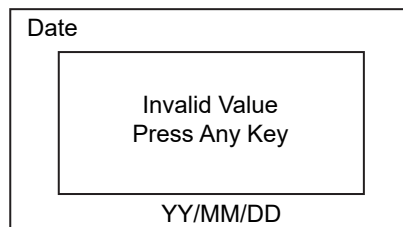

<Right side of the display>



<Left side of the display> [Fig. 1]

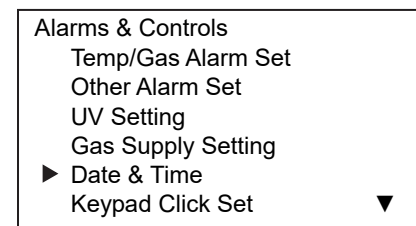

<Left side of the display> [Fig. 2]

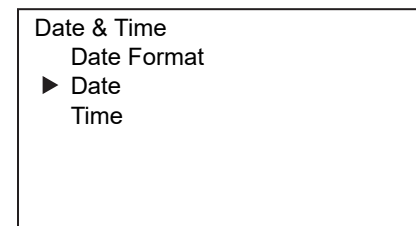

<Left side of the display> [Fig. 3]

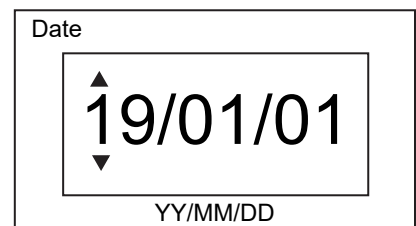

<Right side of the display> [Fig. 4]

7. Press the menu key (MENU/HOME) to display the home screen.
◇The display returns to the home screen automatically when 90 seconds has passed without any key operation.

OTHER PARAMETERS

Setting time

Change the time setting with the following procedure:

1. On the home screen, press the menu key (MENU/HOME).
▶ The left side of the display will change to the Menu screen.
2. Move the cursor on the Menu screen to Alarms & Controls [Fig. 1] using the up/down keys ($\Delta \nabla$), and press the enter key (ENTER).
▶ The display will change to the Alarms & Controls screen.
3. Move the cursor on the Alarms & Controls screen to Date & Time [Fig. 2] using the up/down keys ($\Delta \nabla$), and press the enter key (ENTER).
▶ The display will change to the Date & Time screen.
4. Move the cursor on the Date & Time screen to Time [Fig. 3] using the up/down keys ($\Delta \nabla$), and press the enter key (ENTER).
▶ The right side of the display will change to the Time screen, and the current time will be displayed [Fig. 4].
5. Move the cursor using the left/right keys ($\triangleleft \triangleright$) and select the digit you want to change, and then use the up/down keys ($\Delta \nabla$) to change the number.
6. Press the enter key (ENTER).
▶ The input is confirmed and you will be returned to the Date & Time screen.

*When the entered time is out of the setting range, the following screen will be displayed on the right side of the display: Press any key on the control panel to change to the Time screen [Fig. 4].

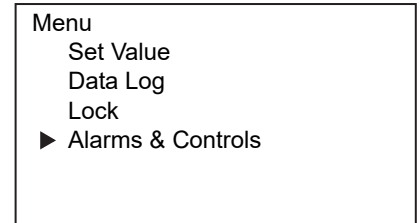

<Left side of the display> [Fig. 1]

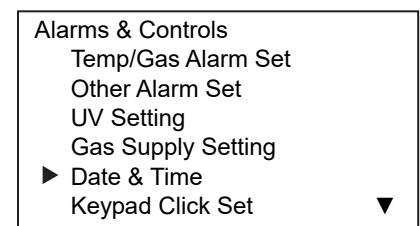

<Left side of the display> [Fig. 2]

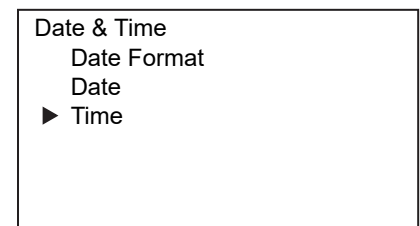

<Left side of the display> [Fig. 3]

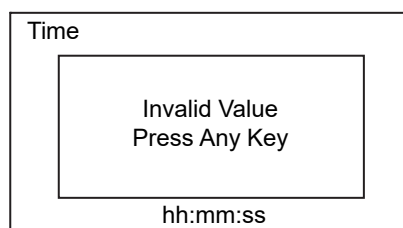

<Right side of the display>

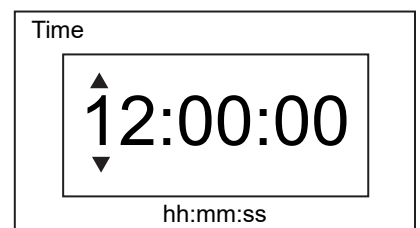

<Right side of the display> [Fig. 4]

7. Press the menu key (MENU/HOME) to display the home screen.
◇ The display returns to the home screen automatically when 90 seconds has passed without any key operation.

Note:

- 24-hour clock.
- It is recommended to set the time periodically since the error of about 1 minute may be observed during a month.

OTHER PARAMETERS

Setting keypad click

Change the key operation sound settings with the following procedure:

- Setting values: ON or OFF
- Default setting (factory setting): ON

1. On the home screen, press the menu key (MENU/HOME).
▶ The left side of the display will change to the Menu screen.

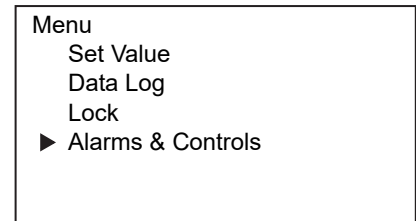

<Left side of the display> [Fig. 1]

2. Move the cursor on the Menu screen to Alarms & Controls [Fig. 1] using the up/down keys (Δ / ∇), and press the enter key (ENTER).
▶ The display will change to the Alarms & Controls screen.

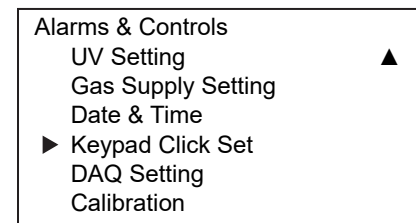

<Left side of the display> [Fig. 2]

3. Move the cursor on the Alarms & Controls screen to Keypad Click Set [Fig. 2] using the up/down keys (Δ / ∇), and press the enter key (ENTER).

▶ The display will change to the Keypad Click Set screen.

4. With the cursor on the Keypad Click Set screen on Keypad Click Set [Fig. 3], press the enter key (ENTER).

The right side of the display will change to the Keypad Click Set screen, and the current setting value (ON) will be displayed [Fig. 4].

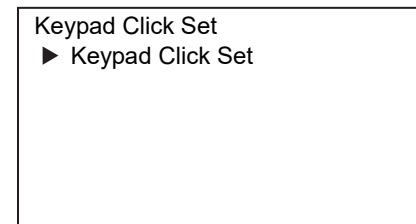

<Left side of the display> [Fig. 3]

5. Use the up/down keys (Δ / ∇) to change the key operation sound setting values.

◇ Each time the up/down key is pressed the input value will change between ON and OFF.

6. Press the enter key (ENTER).

▶ The input is confirmed and you will be returned to the Keypad Click Set screen.

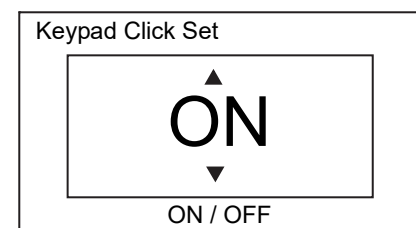

<Right side of the display> [Fig. 4]

7. Press the menu key (MENU/HOME) to display the home screen.

◇ The display returns to the home screen automatically when 90 seconds has passed without any key operation.

ALARMS, SAFETY, AND SELF-DIAGNOSIS

This product has the following warning, safety, and self diagnosis functions.

When the alarm function or the self-diagnosis function works, an error code and error message will be displayed on the display.

Error: Culture ability has decreased sharply. Stop the product and contact your place of business or dealer, unless you know the cause and recovery can be expected.

OLED Display		Conditions	Buzzer	Remote alarm	Safety operation
Home	Alarm				
Err 01: CO ₂ Gas Empty	The CO ₂ density does not increase when the CO ₂ valve is opened.	CO ₂ gas cylinder empty	Intermittent tone	ON	----
Err 05: Temp Sensor Open	The chamber temperature sensor is disconnected.	Chamber temperature sensor error	"	"	Heater OFF
Err 06: Temp Sensor Short	The chamber temperature sensor is short-circuited.		"	"	Heater OFF
Err 09: AT Sensor Open	The ambient temperature sensor is disconnected.	Ambient temperature sensor error	"	"	----
Err 10: AT Sensor Short	The ambient temperature sensor is short-circuited.		"	"	----
Err 11: CO ₂ Sensor Error	The output voltage for the CO ₂ sensor is abnormal.	CO ₂ sensor error	"	"	CO ₂ valve is closed.
Err 13: Main Heater Error	Main heater burnout occurs or the main heater SSR is short-circuited.	Main heater error	"	"	----
Err 14: Humidity Heater Error	Bottom heater burnout occurs or the bottom heater SSR is short-circuited.	Bottom heater error	"	"	----
Err 15: Door Heater Error	Door heater burnout occurs or the door heater SSR is short-circuited.	Door heater error	"	"	----
Err 17: Heater SSR Open	Overheat alarm is activated, or any heater SSR burnout occurs.	SSR disconnection for heater	"	"	----
Err 18: UV Lamp Abnormal	The UV lamp is burnt out.	UV lamp failure	"	"	----
Err 39: Fan Motor Error	Rotational speed of fan motor is abnormal.	Fan motor failure	"	"	----
Err 56: Communication Failure	Communication between display and control is unstable.	Communication error	----	----	----

ALARMS, SAFETY, AND SELF-DIAGNOSIS

Warning: Culture ability may be reduced. If it is a temporary change due to operations, will wait for recovery. Otherwise, please contact your place of business or dealer.

OLED Display		Conditions	Buzzer	Remote alarm	Safety operation
Home	Alarm				
Warning: Over Heat	The chamber's Temperature exceeds the high limit alarm temperature set value.	High limit temperature alarm*1	Continuous tone	ON	Heater OFF.
Warning: High Temp or Warning: Low Temp	The chamber's Temperature is out of the automatic setting range ($\pm 1.0\text{ }^{\circ}\text{C}$ to $\pm 5.0\text{ }^{\circ}\text{C}$).	Automatic set temperature alarm*2	Intermittent tone after set time of alarm delay (0 min to 15 min) has elapsed	ON after set time of alarm delay (0 min to 15 min) has elapsed	----
Warning: High CO ₂ Density or Warning: Low CO ₂ Density	The chamber's CO ₂ density is out of the automatic setting range ($\pm 0.5\%$ to $\pm 5.0\%$).	Automatic set CO ₂ density alarm*2	Intermittent tone after set time of alarm delay (0 min to 15 min) has elapsed	ON after set time of alarm delay (0 min to 15 min) has elapsed	----
Warning: UV Bulb Life	The accumulated ON time has reached approx. 5,000h.	New UV lamp replacement	----	----	----

*1: Shortly after the high-limit temperature alarm is activated, Err17 (Heater SSR burnout) are activated.

*2: When the fan motor speed is lowered due to malfunction or its lifespan, these alarms may be activated because of ununiform distribution of temperature or CO₂ density in the chamber.

Status: We must inform you of the status of the equipment. Please check the situation and take appropriate measures.

OLED Display		Conditions	Buzzer	Remote alarm	Safety operation
Home	Alarm				
Preparing Gas Control	----	After power switch is turned ON, under warming-up before temperature is stable and gas control is enabled.	----	----	----
"Door:Open" is displayed in reverse video.	----	The outer door is open.	Intermittent tone after set time of door alarm delay (1 min to 30 min) has elapsed	----	The CO ₂ valve is closed. The heater turns OFF after 1 min.
"A" or "B" of the CO ₂ gas supply line indicator blinks.	----	CO ₂ cylinder is empty	----	----	----

ALARMS, SAFETY, AND SELF-DIAGNOSIS

- Tables 4–6 show the behaviour of the alarm (buzzer) and ring back function when pressing the BUZZER STOP key.

Table 4. In cases other than those covered in Tables 5 and 6

Remote Alarm setting	Ring Back setting	Buzzer from CO ₂ incubator		Remote Alarm	
		When pressing the BUZZER STOP key	When the Ring Back set time passes	When pressing the BUZZER STOP key	When the Ring Back set time passes
ON: Remote alarm setting not connected with BUZZER STOP key	ON	OFF (Alarm is not cancelled)	ON	ON	ON (Under continuation)
	OFF		OFF		
OFF: Remote alarm setting connected with BUZZER STOP key	ON		ON	OFF (Alarm is not cancelled)	ON
	OFF		OFF		OFF

Note: Resolve the cause of the alarm, as the alarm itself is not deactivated by pressing the BUZZER STOP key.

Table 5. In cases of high-limit temperature alarm

Remote Alarm setting	Ring Back setting	Buzzer from CO ₂ incubator		Remote Alarm		
		When pressing the BUZZER STOP key	When the Ring Back set time passes	When pressing the BUZZER STOP key	When the Ring Back set time passes	
ON: Remote alarm setting not connected with BUZZER STOP key	ON	ON	ON (Under continuation)	ON	ON (Under continuation)	
	OFF					
OFF: Remote alarm setting connected with BUZZER STOP key	ON			ON	(Continue)	ON
	OFF			OFF		OFF

Table 6. In cases of Error01, Error11, Error18, or door alarm*1

Remote Alarm setting	Ring Back setting	Buzzer from CO ₂ incubator		Remote Alarm		
		When pressing the BUZZER STOP key	When the Ring Back set time passes	When pressing the BUZZER STOP key	When the Ring Back set time passes	
ON: Remote alarm setting not connected with BUZZER STOP key	ON	OFF (Alarm is cancelled)	OFF (Alarm is already cancelled)	OFF (Alarm is cancelled*1)	OFF (Alarm is already cancelled*2)	
	OFF					
OFF: Remote alarm setting connected with BUZZER STOP key	ON			ON		ON
	OFF			OFF		OFF

*1: The remote alarm does not work for the door alarm.

Note: When Err01 is activated, connect the new CO₂ gas cylinder and press the BUZZER STOP key to stop the buzzer. In addition, when the optional MCO-21GC is installed and the gas supply is switched to the reserve gas cylinder, press the BUZZER STOP key and replace the gas cylinder.

TROUBLESHOOTING

If the incubator does not seem to be working properly, check the following items before calling a service engineer:

Symptom	Items to check and countermeasures
The incubator does not operate at all.	<ul style="list-style-type: none"> • Is the incubator plugged in? • Is there a power outage, or has a circuit breaker interrupted the power? • The removable power supply cord is connected to the port attached on the lower right side of the cabinet.
An alarm is activated.	<p>[When starting operation]</p> <ul style="list-style-type: none"> • Does the chamber temperature match the set value? • Does the CO₂ gas density in the chamber match the set value? <p>(1) Is the secondary pressure for the gas regulator at the specified value of 0.03 MPa(G)–0.1 MPa(G) (0.3 kgf/cm²(G)–1 kgf/cm²(G), 4.4 psi(G)–14.5 psi(G))?</p> <p>(2) Is the gas tube properly connected?</p> <p>[During operation]</p> <ul style="list-style-type: none"> • Is the high-limit alarm temperature set at least 1 °C higher than the chamber set temperature? • Has the temperature setting been changed? Has the outer door been left open for a long time? Has a low-temperature object been placed in the chamber? If any of these is the case, the alarm will clear automatically after a short time. • Has the gas tube come loose, or is there a gas leak? • Has the CO₂ gas density setting been changed? • Is the gas cylinder empty? Check the primary pressure of the gas cylinder once a week (A primary pressure reading of 3.8 MPa(G) (38 kgf/cm²(G), 551 psi(G)) or lower is a sign that there is little gas remaining. Replace the cylinder soon). • Is the incubator operating beside an appliance that generates electromagnetic waves?
The chamber temperature does not match the set value.	<ul style="list-style-type: none"> • Is the ambient temperature less than 5 °C different from the set value for the chamber temperature? • Is the outer door closed with the inner door left open? • Is the incubator operating beside an appliance that generates electromagnetic waves?
The chamber humidity does not rise.	<ul style="list-style-type: none"> • Is there enough water in the humidifying pan? (Be sure to use sterile distilled water)
The CO ₂ gas density does not match the set value.	<ul style="list-style-type: none"> • Is the secondary pressure for the gas regulator at the specified value of 0.03 MPa(G)–0.1 MPa(G) (0.3 kgf/cm²(G)–1 kgf/cm²(G), 4.4 psi(G)–14.5 psi(G))? • Is the gas tube blocked? • Is the humidifying pan full of sterile distilled water? • Is the duct securely attached? (See page 23) • Is the fan attached properly? (See page 23) • Is the incubator operating beside an appliance that generates electromagnetic waves?
A large quantity of CO ₂ gas is being consumed.	<ul style="list-style-type: none"> • Are the outer and inner doors being frequently opened and closed? • Check whether gas is leaking from connectors due to deterioration of the gas tube, or whether there may be any pinhole leaks. The gas tube is a replaceable part, and it is recommended that it be replaced once a year. • Is the packing seal for the inner door defective? • Is the access hole open?

TROUBLESHOOTING

Symptom	Items to check and countermeasures
Normal cultures are not possible, and the CO ₂ gas density is suspect.	<ul style="list-style-type: none"> • Is the ambient air environment around the incubator normal? Is there a source of polluted gas in the vicinity? • Does the chamber temperature decrease due to those such as that the door is frequently opened and closed, and the water of the humidifying tray is considerably being low? For the heat conduction type CO₂ sensor, CO₂ concentration higher than actual is displayed when the humidity inside the unit decreases due to its characteristics.
CO ₂ gas is not being injected.	<ul style="list-style-type: none"> • CO₂ control for the incubator follows the ON-OFF method. CO₂ gas is intermittently injected as the gas density in the chamber approaches the set value. Injections may be stopped for periods of approximately 15 seconds, but that is not an error.
The CO ₂ gas density is slow to recover.	<ul style="list-style-type: none"> • A HEPA filter is used for the incubator CO₂ gas piping. If gas density is slow to recover when the CO₂ gas pressure is normal, it is possible that the HEPA filter may be clogged. Contact our sales representative or agent. • Is there little gas remaining in the CO₂ gas cylinder? • Is the secondary pressure for the gas regulator at the specified value of 0.03 MPa(G)–0.1 MPa(G) (0.3 kgf/cm²(G)–1 kgf/cm²(G), 4.4 psi(G)–14.5 psi(G))? • Is the gas tube blocked? • Is the duct securely attached? (See page 23) • Is the fan attached properly? (See page 23)

DISPOSAL OF UNIT

Before disposal of this CO₂ incubator, contact our sales representative or agent for further information. Improper handling of biohazardous waste can result in accidental exposure to infectious agents. If there is a danger of biohazard, decontaminate the incubator as thoroughly as possible before disposal.



Label indication is obliged to comply with Taiwanese battery regulation.

DISPOSAL OF UNIT

Disposal of Old Equipment and Batteries

Only for European Union and countries with recycling systems



These symbols on the products, packaging, and/or accompanying documents mean that used electrical and electronic products and batteries must not be mixed with general household waste.

For proper treatment, recovery and recycling of old products and used batteries, please take them to applicable collection points in accordance with your national legislation.

By disposing of them correctly, you will help to save valuable resources and prevent any potential negative effects on human health and the environment.

For more information about collection and recycling, please contact your local municipality.

Penalties may be applicable for incorrect disposal of this waste, in accordance with national legislation.

Note for the battery symbol (bottom symbol):

This symbol might be used in combination with a chemical symbol. In this case it complies with the requirement set by the Directive for the chemical involved.



Likvidácia opotrebovaných zariadení a batérií

Len pre Európsku úniu a krajiny so systémom recyklácie



Tieto symboly uvádzané na výrobkoch, balení a/alebo v sprievodnej dokumentácii informujú o tom, že opotrebované elektrické a elektronické výrobky a batérie sa nesmú likvidovať ako bežný domový odpad.

V záujme zabezpečenia správneho spôsobu likvidácie, spracovania a recyklácie odovzdajte opotrebované výrobky a batérie na špecializovanom zbernom mieste v súlade s platnou legislatívou.

Správnym spôsobom likvidácie týchto výrobkov a batérií prispievate k zachovaniu cenných zdrojov a predídete prípadným negatívnym dopadom na ľudské zdravie a životné prostredie.

Podrobnejšie informácie o zbere a recyklácii vám poskytnú miestne úrady.

Pri nesprávnej likvidácii tohto druhu odpadu môžu byť v súlade s platnou legislatívou udelené pokuty.

Poznámka týkajúca sa symbolu batérie (spodný symbol):

Tento symbol môže byť použitý spolu so symbolom chemickej značky. V takom prípade vyhovuje požiadavke stanovenej Smernicou týkajúcou sa príslušnej chemikálie.



Изхвърляне на излезли от употреба електрически и електронни уреди и батерии

Само за Европейския съюз и страните със системи за рециклиране



Този символ върху продуктите, опаковката и/или придружаващите документи означава, че изразходваните електрически и електронни продукти и батериите не бива да се изхвърлят в общите битови отпадъци.

Моля, предавайте старите продукти и изхабените батерии за обработка, преработка и рециклиране на компетентните пунктове за събиране на отпадъци съгласно законовите разпоредби.

Като изхвърляте тези продукти и батериите правилно, Вие помагате за запазване на ценни ресурси и за избягване на евентуално вредните влияния върху човешкото здраве и околната среда.

За повече информация относно събирането и рециклирането се обърнете към Вашето предприятие на място, предлагащо услуги във връзка с изхвърлянето на отпадъците.

Съгласно разпоредбите в страната за неправилно изхвърляне на тези отпадъци могат да бъдат наложени парични глоби.

Указание за символа батерия (символ долу):

Този символ може да е изобразен в комбинация с химически символ. В този случай това се прави поради изискванията на директивите, издадени за съответния химикал.



Tájékoztató felhasználók számára az elhasználtott készülékek, szárazelemek és akkumulátorok begyűjtéséről és ártalmatlanításáról.

Csak az Európai Unió és olyan országok részére, amelyek begyűjtő rendszerekkel rendelkeznek



A termékeken, a csomagoláson és/vagy a kísérő dokumentumokon szereplő szimbólumok azt jelentik, hogy az elhasználtott elektromos és elektronikus termékekét, szárazelemeket és akkumulátorokat tilos az általános háztartási hulladékkal keverni.

Az elhasználtott készülékek, szárazelemek és akkumulátorok megfelelő kezelése, hasznosítása és újrafelhasználása céljából, kérjük, hogy a helyi törvényeknek, megfelelően juttassa el azokat a kijelölt gyűjtőhelyekre.

E termékek, szárazelemek és akkumulátorok előírászerű ártalmatlanításával Ön hozzájárul az értékes erőforrások megővéséhez, és megakadályozza az emberi egészség és a környezet károsodását.

Amennyiben a begyűjtéssel és újrafelhasználással kapcsolatban további kérdése lenne, kérjük, érdeklődjön a helyi önkormányzatnál.

E hulladékok szabálytalan elhelyezését a nemzeti jogszabályok büntethetik.

Megjegyzés a szárazelem- és akkumulátor-szimbólummal kapcsolatban (alsó szimbólumpélda):

Ezek a szimbólumok kémiai szimbólummal együtt alkalmazhatók. Ebben az esetben teljesíti az EU irányelvnek vegyi anyagra vonatkozó követelményét.



Pozbywanie się zużytych urządzeń elektrycznych i elektronicznych oraz baterii.

Dotyczy wyłącznie obszaru Unii Europejskiej oraz krajów posiadających systemy zbiórki i recyklingu.



Niniejsze symbole umieszczone na produktach, opakowaniach i/lub w dokumentacji towarzyszącej oznaczają, że nie wolno mieszać zużytych urządzeń elektrycznych i elektronicznych oraz baterii z innymi odpadami domowymi/komunalnymi.

W celu zapewnienia właściwego przetworzenia, utylizacji oraz recyklingu zużytych urządzeń elektrycznych i elektronicznych oraz zużytych baterii, należy oddawać je do wyznaczonych punktów gromadzenia odpadów zgodnie z przepisami prawa krajowego.

Poprzez prawidłowe pozbywanie się zużytych urządzeń elektrycznych i elektronicznych oraz zużytych baterii pomagasz oszczędzać cenne zasoby naturalne oraz zapobiegać potencjalnemu negatywnemu wpływowi na zdrowie człowieka oraz na stan środowiska naturalnego.

W celu uzyskania informacji o zbiórce oraz recyklingu zużytych urządzeń elektrycznych i elektronicznych oraz baterii prosimy o kontakt z władzami lokalnymi.

Za niewłaściwe pozbywanie się tych odpadów mogą grozić kary przewidziane przepisami prawa krajowego.

Dotyczy symbolu baterii (symbol poniżej):

Ten symbol może występować wraz z symbolem pierwiastka chemicznego. W takim przypadku wymagania Dyrektywy w sprawie określonego środka chemicznego są spełnione.



Pomembna informacija za pravilno odstranjevanje izrabljene opreme in baterij

Samoz za države EU in države, kjer imajo vzpostavljene sistem recikliranja odpadnih snovi



Simboli na samem izdelku, embalaži ali spremljajočih dokumentih pomenijo, da po koncu življensko dobe aparata, z njim ni dovoljeno ravnati kot z drugimi gospodinjstskimi odpadki.

Vaša dolžnost je, da izrabljeno opremo ali napravo ter baterijske vložke predate v odstranjevanje na posebna zbirna mesta za ločeno zbiranje odpadkov v okviru vaše lokalne skupnosti oziroma zastopniku, ki opravlja dejavnost prevzemanja odpadne električne in elektronske opreme.

S tem, ko jih pravilno odstranite (recikliranje in sortiranje nevarnih odpadkov) varujete naše življensko okolje ter preprečujete negativni vpliv na naravo okrog nas, na naše življensko pomembne vire in vode.

Za dodatne informacije o zbiranju in recikliranju, prosim kontaktirajte vašo lokalno skupnost.

Nepravilno odstranjevanje nevarnih in izrabljenih snovi ter naprav je lahko kaznivo dejanje.

Obvestilo za baterijski simbol (spodnji simbol):

Ta simbol se uporablja v kombinaciji s kemičnim simbolom. V takšnem primeru odgovarja zahtevi, ki jo določa direktiva za dotično kemikalijo.



DISPOSAL OF UNIT

Likvidace použitých zařízení a baterií
Jen pro státy Evropské unie a země s fungujícím systémem recyklace a zpracování odpadu.



Tyto symboly na výrobcích, jejich obalech a v doprovodné dokumentaci upozorňují na to, že se použité elektrické a elektronické zařízení, včetně baterií, nesmějí likvidovat jako běžný komunální odpad.

Aby byla zajištěna správná likvidace a recyklace použitých výrobků a baterií, odevzdávejte je v souladu s národní legislativou na příslušných sběrných místech.

Správnou likvidací přispějete k úspoře cenných přírodních zdrojů a předejdete možným negativním dopadům na lidské zdraví a životní prostředí.

O další podrobnosti o sběru a recyklaci odpadu požádejte místní úřady.

Při nesprávné likvidaci tohoto druhu odpadu se vystavujete postihu podle národní legislativy.

Poznámka k symbolu baterie (značka pod symbolem):
 Tento symbol může být použitý v kombinaci s chemickou značkou. Takový případ je souladu s požadavky směrnice pro chemické látky.

Vanhoiden laitteiden ja paristojen hävittäminen
Vain EU-jäsenmaille ja kierrätysjärjestelmää käyttäville maille



Tämä symboli tuotteissa, pakkauksessa ja/tai asiakirjoissa tarkoittaa, että käytettyjä sähköllä toimivia ja elektronisia tuotteita ei saa laittaa yleisiin talousjätteisiin.

Johda vanhat tuotteet ja käytetyt paristot käsittelyä, uusintia tai kierrätystä varten vastaaviin keräyspisteisiin laissa annettujen määräysten mukaisesti.

Hävittämällä tuotteet asiaankuuluvasti, autat samalla suojaamaan arvokkaita luonnonvaroja ja estämään mahdollisia negatiivisia vaikutuksia ihmiseen ja luontoon.

Lisätietoa keräämisestä ja kierrätyksestä saa paikalliselta jätehuollosta vastuulliselta viranomaiselta.

Maiden lainsäädännön mukaisesti tämän jätteen määrätystenvastaisesta hävittämisestä voidaan antaa sakkorangaistuksia.

Huomautus paristosymbolista (symboli alhaalla):
 Tämä symboli voidaan näyttää jonkin kemiallisen symbolin yhteydessä. Siinä tapauksessa se perustuu vastaaviin direktiiveihin, jotka on annettu kyseessä olevalle kemikaalille.

Eski Ekipman ve Bataryaların Tasfiyesi
Sadece Avrupa Birliği ve geri dönüşüm sistemleri olan ülkeler için



Ürünlerin, ambalajın ve/veya ek olarak gelen belgelerin üzerindeki bu semboller, elektrikli ve elektronik ürünlerin ve bataryaların genel ev atıklarıyla karıştırılmaması gerektiği anlamına gelir.

Eski ürünlerin ve kullanılmış bataryaların doğru şekilde işlenmesi, geri kazanımı ve geri dönüşümü için lütfen bunları ulusal kanunlara uygun olan toplama noktalarına götürün.

Bunları doğru şekilde tasfiye ederek değerli kaynakları kurtarmaya ve insan sağlığı ve çevre üzerinde oluşabilecek olumsuz etkileri önlemeye yardım edeceksiniz.

Toplama ve geri dönüşüm hakkında daha fazla bilgi için lütfen bölgenizdeki belediye ile irtibat kurun.

Bu atığın yanlış şekilde tasfiye edilmesi durumunda ulusal kanunlar uyarınca cezalar verilebilir.

Batarya sembolüne bakın (alttaki sembol):
 Bu sembol bir kimyasal sembolü ile birlikte kullanılmış olabilir. Bu durumda batarya, kullanılan kimyasal maddeye yönelik Direktif ile belirlenen şartı karşılıyordu.

Entsorgung von Altgeräten und Batterien
Nur für die Europäische Union und Länder mit Recyclingsystemen



Dieses Symbol, auf den Produkten, der Verpackung und/oder den Begleitdokumenten, bedeutet, dass gebrauchte elektrische und elektronische Produkte sowie Batterien nicht in den allgemeinen Hausmüll gegeben werden dürfen.

Bitte führen Sie alte Produkte und verbrauchte Batterien zur Behandlung, Aufarbeitung bzw. zum Recycling gemäß den gesetzlichen Bestimmungen den zuständigen Sammelpunkten zu. Endnutzer sind in Deutschland gesetzlich zur Rückgabe von Altbatterien an einer geeigneten Annahmestelle verpflichtet. Batterien können im Handelsgeschäft unentgeltlich zurückgegeben werden.

Indem Sie diese Produkte und Batterien ordnungsgemäß entsorgen, helfen Sie dabei, wertvolle Ressourcen zu schützen und eventuelle negative Auswirkungen auf die menschliche Gesundheit und die Umwelt zu vermeiden.

Für mehr Informationen zu Sammlung und Recycling, wenden Sie sich bitte an Ihren örtlichen Abfallentsorgungsdienstleister.

Gemäß Landesvorschriften können wegen nicht ordnungsgemäßer Entsorgung dieses Abfalls Strafgeelder verhängt werden.

Hinweis für das Batteriesymbol (Symbol unten):
 Dieses Symbol kann in Kombination mit einem chemischen Symbol abgebildet sein. In diesem Fall erfolgt dieses auf Grund der Anforderungen derjenigen Richtlinien, die für die betreffende Chemikalie erlassen wurden.

L'élimination des équipements et des batteries usagés
Applicable uniquement dans les pays membres de l'Union européenne et les pays disposant de systèmes de recyclage.



Apposé sur le produit lui-même, sur son emballage, ou figurant dans la documentation qui l'accompagne, ce pictogramme indique que les piles, appareils électriques et électroniques usagés, doivent être séparées des ordures ménagères.

Afin de permettre le traitement, la valorisation et le recyclage adéquats des piles et des appareils usagés, veuillez les porter à l'un des points de collecte prévus, conformément à la législation nationale en vigueur.

En les éliminant conformément à la réglementation en vigueur, vous contribuez à éviter le gaspillage de ressources précieuses ainsi qu'à protéger la santé humaine et l'environnement.

Pour de plus amples renseignements sur la collecte et le recyclage, veuillez vous renseigner auprès des collectivités locales.

Le non-respect de la réglementation relative à l'élimination des déchets est passible d'une peine d'amende.

Note relative au pictogramme à apposer sur les piles (pictogramme du bas) :
 Si ce pictogramme est combiné avec un symbole chimique, il répond également aux exigences posées par la Directive relative au produit chimique concerné.

Eliminación de Aparatos Viejos y de Pilas y Baterías
Solamente para la Unión Europea y países con sistemas de reciclado.



Estos símbolos en los productos, su embalaje o en los documentos que los acompañan significan que los productos eléctricos y electrónicos y pilas y baterías usadas no deben mezclarse con los residuos domésticos.

Para el adecuado tratamiento, recuperación y reciclaje de los productos viejos y pilas y baterías usadas llévelos a los puntos de recogida de acuerdo con su legislación nacional. En España, los usuarios están obligados a entregar las pilas en los correspondientes puntos de recogida. En cualquier caso, la entrega por los usuarios será sin coste alguno para éstos. El coste de la gestión medioambiental de los residuos de pilas, acumuladores y baterías está incluido en el precio de venta.

Si los elimina correctamente ayudará a preservar valiosos recursos y evitará potenciales efectos negativos sobre la salud de las personas y sobre el medio ambiente.

Para más información sobre la recogida u reciclaje, por favor contacte con su ayuntamiento.

Puede haber sanciones por una incorrecta eliminación de este residuo, de acuerdo con la legislación nacional.

Nota para el símbolo de pilas y baterías (símbolo debajo):
 Este símbolo puede usarse en combinación con el símbolo químico. En este caso, cumple con los requisitos de la Directiva del producto químico indicado.

DISPOSAL OF UNIT

Smaltimento di vecchie apparecchiature e batterie usate Solo per Unione Europea e Nazioni con sistemi di raccolta e smaltimento



Questi simboli sui prodotti, sull'imballaggio e/o sulle documentazioni o manuali accompagnanti i prodotti indicano che i prodotti elettrici, elettronici e le batterie usate non devono essere buttati nei rifiuti domestici generici.

Per un trattamento adeguato, recupero e riciclaggio di vecchi prodotti e batterie usate vi invitiamo a portarli negli appositi punti di raccolta secondo la legislazione vigente nel vostro paese.

Con uno smaltimento corretto, contribuirete a salvare importanti risorse e ad evitare i potenziali effetti negativi sulla salute umana e sull'ambiente.

Per ulteriori informazioni su raccolta e riciclaggio, vi invitiamo a contattare il vostro comune.

Lo smaltimento non corretto di questi rifiuti potrebbe comportare sanzioni in accordo con la legislazione nazionale.

Note per il simbolo batterie (simbolo sotto):

Questo simbolo può essere usato in combinazione con un simbolo chimico. In questo caso è conforme ai requisiti indicati dalla Direttiva per il prodotto chimico in questione.



Eliminação de Equipamentos Usados e Baterias Apenas para a União Europeia e países com sistemas de reciclagem



Estes símbolos nos produtos, embalagens, e/ou documentos que os acompanham indicam que os produtos elétricos e eletrônicos e as baterias usados não podem ser misturados com os resíduos urbanos indiferenciados.

Para um tratamento adequado, reutilização e reciclagem de produtos e baterias usados, solicitamos que os coloque em pontos de recolha próprios, em conformidade com a respetiva legislação nacional.

Ao eliminar estes produtos corretamente estará a ajudar a poupar recursos valiosos e a prevenir quaisquer potenciais efeitos negativos sobre o ambiente e a saúde humana.

Para mais informações acerca da recolha e reciclagem, por favor contacte a sua autarquia local.

De acordo com a legislação nacional podem ser aplicadas contraordenações pela eliminação incorreta destes resíduos.

Nota para o símbolo da bateria (símbolo na parte inferior):

Este símbolo pode ser utilizado conjuntamente com um símbolo químico. Neste caso estará em conformidade com o estabelecido na Diretiva referente aos produtos químicos em causa.



Depunerea la deșeurii a echipamentelor și a bateriilor vechi Doar pentru Uniunea Europeană și pentru țările cu sisteme de reciclare



Aceste simboluri de pe produse, ambalaje și/sau documentele însoțitoare indică faptul că produsele electrice și electronice, precum și bateriile uzate nu trebuie să fie amestecate cu deșeurile menajere obișnuite.

Pentru un tratament corespunzător, pentru recuperarea și reciclarea produselor vechi și a bateriilor uzate, vă rugăm să le depuneți la punctele de colectare special amenajate, în conformitate cu legislația națională.

Prin depunerea corespunzătoare a acestora la deșeurii, veți ajuta la economisirea unor resurse valoroase și veți preveni potențiale efecte negative asupra sănătății umane și asupra mediului înconjurător.

Pentru mai multe informații despre colectare și reciclare, vă rugăm să contactați autoritățile locale.

Este posibil ca depunerea în corectă la deșeurii să fie pedepsită în conformitate cu legile naționale.

Notă pentru simbolul de baterie (ultimele două exemple de simboluri):

Acest simbol poate fi utilizat în combinație cu un simbol chimic. În acest caz, acesta este conform cu cerințele stabilite de Directivă pentru elementul chimic în cauză.



Indsamling af elektronikskrot og brugte batterier Kun for Den Europæiske Union og lande med retursystemer



Disse symboler på produkter, emballage og/eller ledsagedokumenter betyder, at brugte elektriske og elektroniske produkter og batterier ikke må blandes med almindeligt husholdningsaffald.

For korrekt behandling, indsamling og genbrug af gamle produkter og batterier, skal du tage dem til indsamlingssteder i overensstemmelse med den nationale lovgivning.

Ved at skaffe sig af med dem på korrekt vis hjælper du med til at spare værdifulde ressourcer og forhindre eventuelle negative påvirkninger af menneskers sundhed og miljøet.

Ønsker du mere udførlig information om indsamling og genbrug skal du kontakte din kommune.

Usagkyndig bortskaffelse af elektronikskrot og batterier kan eventuelt udløse bødeforlæggelse.

Information om batterisymbol (eksempler nedenfor):

Dette symbol kan anvendes sammen med et kemisk symbol. I så fald opfylder det kravene for det direktiv, som er blevet fastlagt for det pågældende kemikalie.



Senų prietaisų ir akumuliatorių utilizavimas Taikoma tik Europos Sąjungai ir šalims, kurie naudojamus perdirbimo sistemas



Jei ant pakuotės ir (arba) lydymuosiuose dokumentuose nurodytas šis simbolis, vadinasi, naudotų elektrinių ir elektroninių gaminių ir akumuliatorių negalima išmesti kartu įprastomis buitinėmis atliekomis.

Senus produktus ir naudotus akumuliatorius perduokite apdirbti, likviduoti arba perdirbti kompetentingiems surinkimo punktais pagal įstatymų galios potvarkius.

Šiuos gaminius ir akumuliatorius perdavę tinkamai utilizuoti, padėsite išsaugoti vertingus išteklius ir išvengti neigiamo poveikio žmogaus sveikatai ir aplinkai.

Jei norite gauti daugiau informacijos apie surinkimą ir perdirbimą, kreipkitės į vietos atliekų utilizavimo paslaugų teikėją.

Remiantis šalyje galiojančiais potvarkiais, už netinkamą tokių atliekų utilizavimą gali būti skirta bauda.

Akumuliatoriaus simbolio nuoroda (simbolis apačioje):

Kartu su šiuo simboliu gali būti pateiktas cheminių medžiagų simbolis. Šis simbolis pateikiamas, kai būtina laikytis atitinkamiems chemikalams taikomų direktyvų reikalavimų.



Rimi ta' Tagħmir Antik u Batteriji Għall-Unjoni Ewropea u għall-pajjiżi b'sistemi ta' riċiklaġġ biss



Dawn is-simboli fuq il-prodotti, l-imballaġġ u/jew id-dokumenti ta' akkumpanjament ifissru li prodotti elettrici u elettronici u batteriji użati ma jridux jiġu mħallta ma' skart domestiku ġenerali.

Għal trattament, irkupru u riċiklaġġ xieraq ta' prodotti antik u batteriji użati, jekk jogħġbok hudhom f'punti tal-ġbir applikabbli f'konformità mal-leġislazzjoni nazzjonali tiegħek.

Billi tarmihom b'mod xieraq, tghin sabiex tikkonserva riżorsi prezzjużi u tippreveni kwalunkwe effett negattiv potenzjali fuq is-saħħa tal-bniedem u l-ambjent.

Għal aktar informazzjoni dwar il-ġbir u r-riċiklaġġ, jekk jogħġbok ikkuntattja lill-municipalitá lokali tiegħek.

F'każ ta' rimi mhux korrett ta' dan l-iskart jistgħu japplikaw penali, f'konformità mal-leġislazzjoni nazzjonali.

Nota għas-simbolu tal-batterija (simbolu ta' taħt):

Dan is-simbolu jista' jintuża f'kombinazzjoni ma' simbolu tal-kimika. F'dan il-każ jikkonforma mar-rekwiżit stabbilit mid-Direttiva għall-kimika involuta.



Zbrinjavanje starih uređaja i baterija Samo za Europsku uniju i zemlje koje posjeduju sustav recikliranja



Ovaj simbol na proizvodima, pakiranju i/ili popratnim dokumentima znači da se iskorišteni električni i električni proizvodi te baterije ne smiju bacati u kućanski otpad.

Molimo vas da prema zakonskim odredbama stare proizvode i istrošene baterije predate na ovlaštenim sabiralištima na daljnju obradu, pripremu odn. recikliranje.

Ako te proizvode i baterije propisno zbrinete, pomažete pri zaštiti dragocjenih resursa, a istovremeno i izbjegavate eventualne negativne utjecaje na ljudsko zdravlje i okoliš.

Za više informacija o zbrinjavanju i recikliranju obratite se svojem lokalnom komunalnom poduzeću.

Zbog nepropisnog zbrinjavanja ovog otpada mogu se, ovisno o lokalnim propisima zemlje, izreći i novčane kazne.

Napomena za simbol baterije :

Ovaj simbol može biti prikazan samo u kombinaciji s kemijskim simbolom. U tom se slučaju upotrebljava na temelju zahtjeva onih direktiva koje su donesene za dotičnu kemikaliju.



DISPOSAL OF UNIT

Avfallshandtering av produkter och batterier

Endast för Europeiska Unionen och länder med återvinningssystem



Dessa symboler på produkter, förpackningar och/eller medföljande dokument betyder att förbrukade elektriska och elektroniska produkter och batterier inte får blandas med vanliga hushållssopor.

För att gamla produkter och använda batterier ska hanteras och återvinnas på rätt sätt ska dom lämnas till passande uppsamlingsställe i enlighet med nationella bestämmelser.

Genom att ta göra det korrekt hjälper du till att spara värdefulla resurser och förhindrar eventuella negativa effekter på människors hälsa och på miljön.

För mer information om insamling och återvinning kontakta din kommun.

Olämplig avfallshandtering kan beläggas med böter i enlighet med nationella bestämmelser.

Notering till batterisymbolen (nedanför):

Denna symbol kan användas i kombination med en kemisk symbol. I detta fall uppfyller den de krav som ställs i direktivet för den aktuella kemikalien.



Brukerinformasjon om innsamling av gammelt utstyr og brukte batterier

Bare for EU og land med retursystemer



Slike symboler på produkter, emballasje, og/eller på medfølgende dokumenter betyr at brukte elektriske/elektroniske produkter og batterier ikke må blandes med vanlig husholdningsavfall.

For riktig håndtering og gjenvinning av gamle produkter og brukte batterier, vennligst lever dem til innsamlingssteder i samsvar med nasjonallovgivning.

Ved riktig håndtering av disse produktene og batteriene, hjelper du til med å spare verdifulle ressurser og forhindre potensielle negative effekter på menneskers helse og miljø.

For mer informasjon om innsamling og gjenvinning vennligst ta kontakt med din kommune.

Ukorrekt håndtering av dette avfallet kan medføre straffansvar, i overensstemmelse med nasjonal lovgivning.

Merknader for batterisymbolet (nederste symbol):

Dette symbolet kan bli brukt i kombinasjon med et kjemisk symbol. I dette tilfellet etterkommer det kravet satt av direktivet for det kjemikalie det gjelder.



Het ontdoen van oude apparatuur en batterijen.

Enkel voor de Europese Unie en landen met recycle systemen.



Deze symbolen op de producten, verpakkingen en/of begeleidende documenten betekenen dat gebruikte elektrische en elektronische producten en batterijen niet samen mogen worden weggegooid met de rest van het huishoudelijk afval.

Voor een juiste verwerking, hergebruik en recycling van oude producten en batterijen, gelieve deze in te leveren bij de desbetreffende inleverpunten in overeenstemming met uw nationale wetgeving.

Door ze op de juiste wijze weg te gooien, helpt u mee met het besparen van kostbare hulpbronnen en voorkomt u potentiële negatieve effecten op de volksgezondheid en het milieu.

Voor meer informatie over inzameling en recycling kunt u contact opnemen met uw plaatselijke gemeente.

Afhankelijk van uw nationale wetgeving kunnen er boetes worden opgelegd bij het onjuist weggooien van dit soort afval.

Let op: het batterij symbool (Onderstaand symbool).

Dit symbool kan in combinatie met een chemisch symbool gebruikt worden. In dit geval volstaan de eisen, die zijn vastgesteld in de richtlijnen van de desbetreffende chemische stof.



Απόρριψη παλαιών συσκευών και μπαταριών

Μόνο για την Ευρωπαϊκή Ένωση και χώρες με συστήματα ανακύκλωσης



Το σύμβολο αυτό, πάνω στα προϊόντα, τη συσκευασία ή/και τα συνοδευτικά έγγραφα, υποδηλώνει ότι τα χρησιμοποιημένα ηλεκτρικά και ηλεκτρονικά προϊόντα, καθώς και οι μπαταρίες, δεν πρέπει να απορρίπτονται στα κοινά οικιακά απορρίμματα.

Παρακαλούμε παραδώστε τα παλαιά προϊόντα και τις χρησιμοποιημένες μπαταρίες για διαχείριση, επεξεργασία ή/και ανακύκλωση σύμφωνα με τις νομικές διατάξεις των αρμόδιων αρχών αποκομιδής.

Με την ορθή απόρριψη αυτών των προϊόντων και μπαταριών, συμβάλλετε στην εξοικονόμηση πολύτιμων πόρων και την αποφυγή τυχόν αρνητικών επιπτώσεων στην ανθρώπινη υγεία και το περιβάλλον.

Για περισσότερες πληροφορίες σχετικά με τη συλλογή και την ανακύκλωση, παρακαλούμε απευθυνθείτε στις κατά τόπους υπηρεσίες συγκομιδής απορριμμάτων.

Σε περίπτωση αντικανονικής απόρριψης αυτού του προϊόντος ενδεχομένως να επιβληθούν πρόστιμα, ανάλογα με τη νομοθεσία του εκάστοτε κράτους.

Σημείωση για το σύμβολο μπαταρίας (σύμβολο κάτω):

Το σύμβολο αυτό μπορεί να απεικονίζεται σε συνδυασμό με ένα χημικό σύμβολο. Αυτό γίνεται ώστε να υπάρχει συμφωνία με τις απαιτήσεις των εκάστοτε οδηγιών, που εκδόθηκαν για το εν λόγω χημικό.



Nolietoto elektronisko ierīču un elektropreču un bateriju utilizācija

Tikai Eiropas valstīs ar utilizācijas sistēmu



Šis simbols, kas izvietots uz ražojumiem, iesaiņojuma un/vai pavaddokumentiem nozīmē, ka nolietotās elektroniskās ierīces un elektropreces, kā arī baterijas nedrīkst izmest kopā ar parastiem mājsaimniecības atkritumiem.

Nogādājiet nolietotos ražojumus un nokalpojušās baterijas tālākai apstrādei, pārstrādei, resp., materiālu atsevišķai pārstrādei attiecīgajās atkritumu savākšanas vietās saskaņā spēkā esošajām likumdošanas prasībām.

Nododot šos ražojumus un baterijas profesionālai utilizācijai, jūs palīdzēsiet saudzēt vērtīgus resursus un novērsīsiet iespējamo kaitējumu cilvēku veselībai un un apkārtējai videi.

Lai iegūtu plašāku informāciju par atkritumu savākšanu un atsevišķo pārstrādi, lūdzam vērsties savā vietējā atkritumu pārstrādes uzņēmumā.

Saskaņā ar nacionālo likumdošanu par nepareizu šāda veida atkritumu utilizāciju var uzlikt naudas sodu.

Norāde par baterijas simbolu (simbols apakšā):

Šis simbols var būt attēlots kombinācijā ar ķīmiskās vielas simbolu. Tādā gadījumā tas ir apzīmēts atbilstoši attiecīgo Direktīvu prasībām, kas pieņemtas attiecībā uz attiecīgo ķīmikāliju.



Уклањање старих апарата и батерија

Само за Европску Унију и државе са системима рециклирања



Овај симбол на производима, паковању и/или пратећим документима значи да коришћени електрични и електронски апарати не смеју бити бачени у обично кућно хубре.

Молимо да сходно законским одредбама однесете старе производе и искоришћене батерије у надлежна сабирна места на третман, прераду, односно рециклирање.

Тиме што ћете ове производе и батерије правилно уклонити помажете да се притом заштите вредни ресурси и избегну евентуална негативна дејства на људско здравље и човекову околину.

Молимо да се за више информација у вези сакупљања и рециклирања обратите Вашој месној служби за уклањање отпада.

За непрописно уклањање овог отпада могу бити изречене новчане казне према прописима државе.

Упутство за симбол за батерију (симбол доле):

Овај симбол може бити илустрован у комбинацији са хемијским симболом. У том случају ово следи на основу захтева оних смерница које су донешене за дотичне хемикалије.



Vanade seadmete ja patareide jäätmekäitlus

Ainult Euroopa Liidule ja ringlussevõtu süsteemidega riikidele



Toodetel, pakendil ja/või kaasasolevatel dokumentidel olevad sümbolid tähendavad, et elektri- ja elektroonikatooteid ja patareiseid ei tohi visata tavaliste olmejäätmete hulka.

Vanade toodete ja kasutatud patareide nõuetekohaseks töötlemiseks, taastamiseks ja ringlusse võtmiseks viige need ettenähtud kogumiskohtadesse vastavalt riiklikele õigusaktidele.

Nende toodete ja patareide korrektse kõrvaldamisega aitate säästa hinnalisi ressursse ning vältida võimalikke kahjulikke mõjusid inimeste tervisele ja keskkonnale.

Täpsema teabe saamiseks kogumise ja ringlussevõtu kohta pöörduge kohaliku omavalitsuse poole.

Vastavalt riiklikele õigusaktidele võib selliste jäätmete ebakorrekse käitlemisega kaasneda trahv.

Märkus patarei sümboli kohta:

Seda sümbolit võib kasutada kombinatsioonis keemilise sümboliga. Sellisel juhul vastab see asjaomase kemikaali kasutamist reguleeriva direktiivi nõuetele.



SPECIFICATIONS

Product name	CO ₂ Incubator MCO-170ACL		
Model number	MCO-170ACL-PA	MCO-170ACL-PE	
External dimensions	W 620 mm x D 730 mm x H 905 mm (W 24.4 in. x D 28.7 in. x H 35.6 in.)		
Internal dimensions	W 490 mm x D 523 mm x H 665 mm (W 19.3 in. x D 20.6 in. x H 26.2 in.)		
Interior volume	165L (5.83 cu.ft.)		
Exterior	Painted steel (Rear cover has no paint)		
Interior	Stainless steel containing copper		
Outer door	Painted steel		
Inner door	Tempered glass		
Trays	3 trays made of stainless steel containing copper W 470 mm x D 450 mm x H 12 mm (W 18.5 in. x D 17.7 in. x H 0.47 in.) Maximum load: 7 kg/tray		
Access port	Inner diameter: 30 mm (1.18 in.); on the back side		
Insulation	Styrene AcryloNitrile copolymer		
Heating system	DHA system (heater jacket + air jacket system)		
Heater	287 W	290 W	
Humidifying system	Natural evaporation with humidifying pan		
Temperature controller	PID control system		
Temperature display	Digital display		
CO ₂ controller	PID control system		
CO ₂ density display	Digital display		
Air circulation	Fan-assisted		
Air filter	0.3 μm, Efficiency: 99.97 % or higher		
Alarms	Automatic set temperature alarm, Automatic set CO ₂ density alarm, High-limit temperature alarm, CO ₂ gas, various sensor/heater alarms		
Remote alarm contacts	Allowable contact capacity: DC 30 V, 2 A *1		
CO ₂ inlet connection	4 mm to 6 mm (0.157 in. to 0.236 in.) diameter tube can be connected		
CO ₂ inlet pressure	0.03 MPa(G)–0.1 MPa(G) (0.3 kgf/cm ² (G)–1 kgf/cm ² (G), 4.4 psi(G)–14.5 psi(G))		
Weight	74 kg		
Accessories	1 removable power supply cord *2, 1 power supply cord cover plate, 3 trays, 1 gas tube, 1 humidifying pan, 2 tube bands		
Optional accessories	Double-stacking bracket (MCO-170PS) *3 Stacking plate (MCO-170SB) *3 UV system set (MCO-170UVS) Gas regulator (MCO-010R) Gas auto changer (MCO-21GC) Tray (MCO-170ST: same as that of standard accessory) Half tray (MCO-25ST) Roller base (MCO-170RB) Small door (MCO-170ID) Interface board (MCO-420MA) Interface board (MTR-L03) *1 *4; for LAN Interface board (MTR-480) *1 *4; for RS-232C/RS-485		

*1: It is recommended to use standard signal and interface cables with a maximum length of 30 meters.

*2: For the MCO-170ACL-PE for EU countries, 2 power supply removable cords are supplied with it (see page 27).

*3: Refer to Table 7

*4: Only for the Data acquisition system MTR-5000 user.

Note: Refer to the updated catalogue when ordering an optional component.
Designs and specifications are subject to change without notice.

Table 7. Bracket/plate required for each combination of double-stacking incubators

Upper product	MCO-170AC series MCO-170AIC series MCO-170AICD series MCO-170M series			
Lower product	MCO-170AC series MCO-170AIC series MCO-170AICD series MCO-170M series	MCO-19AIC series MCO-19M series	MCO-18AC MCO-20AIC	MCO-230AIC series
Bracket/ Plate	Double-stacking bracket MCO-170PS	Stacking plate MCO-170SB		Stacking plate MCO-230SB

PERFORMANCE

Product name	CO ₂ Incubator MCO-170ACL	
Model number	MCO-170ACL-PA	MCO-170ACL-PE
Temperature control range	Ambient temperature+5 °C to 50 °C* (ambient temperature: 5 °C to 35 °C)	
Temperature distribution	±0.25 °C (ambient temperature: 23 °C, setting: 37 °C, CO ₂ : 5 %, no load)	
Temperature variation	±0.1 °C (ambient temperature: 23 °C, setting: 37 °C, CO ₂ : 5 %, no load)	
CO ₂ setting range	0 % to 20 %	
CO ₂ variation	±0.15 % (ambient temperature: 23 °C, setting: 37 °C, CO ₂ : 5 %, no load)	
Chamber humidity	95 %R.H.±5 %R.H.	
Applicable environmental condition	Temperature: 5 °C to 35 °C, Humidity: 80 %R.H. max. (The optimum performance may not be obtained if the ambient temperature is not above 15 °C)	
Noise level	29 dB (A scale)	
Power consumption	Max. 295 W	Max. 298 W
Heat emission	Max. 1040 kJ/h	Max. 1050 kJ/h
Rated voltage, frequency	AC 110 V–120 V, 60 Hz	AC 220 V–240 V, 50 Hz/60 Hz
Amperage	Max. 2.6 A	Max. 1.4 A

* When set temperature is 37 °C, ambient temperature must be 32 °C or less. Regardless of ambient temperature, the maximum of temperature control range is always 50 °C.

Note:

- The unit with CE mark complies with EU directives.
- Based on our measuring method.
- Default calibration conditions : 37 °C, CO₂: 5 %
When using under other conditions, we recommend calibration under the conditions of use.
- We recommend calibration every year.

⚠ CAUTION

**Please fill in this form before servicing.
Hand this form to the service engineer to keep for his and your safety.**

Safety check sheet

1. Unit contents :

- Risk of infection: Yes No
Risk of toxicity: Yes No
Risk from radioactive sources: Yes No

(List all potentially hazardous materials that have been stored in this unit.)

Notes :

2. Contamination of the unit

Unit interior

- No contamination Yes No
Decontaminated Yes No
Contaminated Yes No

Others:

3. Instructions for safe repair/maintenance/disposal of the unit

- a) The unit is safe Yes No
b) There is some danger (see below) Yes No

Procedure to be adhered to in order to reduce safety risk indicated in b) below.

Date :

Signature :

Address, Division :

Telephone :

Product name :

CO₂ Incubator

Model No.

MCO-

Serial number :

Date of Installation :

Please decontaminate the unit yourself before calling the service engineer.



PHC Corporation

1-1-1 Sakada, Oizumi-machi, Ora-gun, Gunma 370-0596, Japan

© PHC Corporation 2018

Printed in Indonesia
LDCL055900-0
N1018-0