

Operating Manual

Translation of the original operating manual

BD / BD-UL (E2) – Incubators with natural convection

ED / ED-UL (E2) – Drying and heating ovens with natural convection

FD / FD-UL (E2) – Drying and heating ovens with forced convection

with microprocessor temperature controller

Modell	Model version	Art. No.	Modell	Model version	Art. No.
BD 23	BD023-230V	9010-0187	ED 240	ED240-230V	9010-0101
	BD023UL-120V	9010-0189		ED240UL-208V	9010-0167
BD 53	BD053-230V	9010-0081	ED400	ED400-230V	9010-0075
	BD053UL-120V	9010-0179		ED400UL-208V	9010-0168
BD 115	BD115-230V	9010-0088	ED720	ED720-230V	9010-0076
	BD115UL-120V	9010-0181		ED720UL-208V	9010-0169
BD 240	BD240-230V	9010-0095	FD 23	FD023-230V	9010-0194
	BD240UL-120V	9010-0183		FD023UL-120V	9010-0196
BD400	BD400-230V	9010-0073	FD 53	FD053-230V	9010-0082
	BD400UL-120V	9010-0176		FD053UL-120V	9010-0128
BD720	BD720-230V	9010-0074	FD 115	FD115-230V	9010-0102
	BD720UL-120V	9010-0177		FD115UL-120V	9010-0129
ED 23	ED023-230V	9010-0190/0191	FD 240	FD240-230V	9010-0104
	ED023UL-120V	9010-0192/0193		FD240UL-208V	9010-0130
ED 53	ED053-230V	9010-0078/0079			
	ED053UL-120V	9010-0131/0132			
ED 115	ED115-230V	9010-0096/0097			
	ED115UL-120V	9010-0164/0165			

BINDER GmbH

- ▶ Address: Post office box 102, 78502 Tuttlingen, Germany ▶ Phone: +49 7462 2005 0
- ▶ Fax: +49 7462 2005 100 ▶ Internet: <http://www.binder-world.com>
- ▶ E-mail: info@binder-world.com ▶ Service Hotline: +49 7462 2005 555
- ▶ Service Fax: +49 7462 2005 93 555 ▶ Service E-Mail: service@binder-world.com
- ▶ Service Hotline USA: +1 866 885 9794 or +1 631 224 4340 x3
- ▶ Service Hotline Asia Pacific: +852 390 705 04 or +852 390 705 03
- ▶ Service Hotline Russia and CIS: +7 495 988 15 16

Content

1. SAFETY	4
1.1 Legal considerations	4
1.2 Structure of the safety instructions	4
1.2.1 Signal word panel	4
1.2.2 Safety alert symbol	5
1.2.3 Pictograms	5
1.2.4 Word message panel structure	6
1.3 Localization / position of safety labels on the chamber	6
1.4 Type plate	7
1.5 General safety instructions on installing and operating the chambers	8
1.6 Intended use	10
1.7 Operating instructions	11
1.8 Measures to prevent accidents	11
2. CHAMBER DESCRIPTION	12
2.1 Chamber overview	13
3. COMPLETENESS OF DELIVERY, TRANSPORTATION, STORAGE, AND INSTALLATION	13
3.1 Unpacking, and checking equipment and completeness of delivery	13
3.2 Guidelines for safe lifting and transportation	14
3.3 Storage	14
3.4 Location of installation and ambient conditions	15
4. INSTALLATION OF THE EQUIPMENT	16
4.1 Electrical connection	16
4.2 Connection to a suction plant (optional)	17
5. START UP	17
5.1 Turning on the chamber	17
5.2 Heating operation display	17
5.3 Air change	18
6. OPERATING THE CONTROLLER	18
6.1 Display / entry of temperature set-point (without ramp function)	18
6.2 Display / entry of temperature set-point (with selected temperature ramp)	19
6.3 Time functions: Continuous operation and Timer operation	20
6.3.1 Switching between "Continuous operation" and "Timer operation"	21
6.3.2 Continuous operation	21
6.3.3 Timer operation: Setting the tempering time	22
6.4 User level settings	23
6.4.1 Temperature unit change between degrees Celsius °C and degrees Fahrenheit °F	23
6.4.2 Entering a temperature ramp	24
6.4.3 Chamber addressing	24
6.5 General notes	25
7. TEMPERATURE SAFETY DEVICES	26
7.1 Temperature safety device class 2 (DIN 12880) ED, FD	26
7.2 Temperature safety device class 3.1 (DIN 12880) BD (option for ED, FD)	27

8. OPTIONS.....	29
8.1 Disconnectable audible over-temperature alarm (option).....	29
8.2 APT-COM™ 4 Multi Management Software (option for BD and ED)	29
8.3 Data logger kit (option).....	29
8.4 Additional Pt100 temperature sensor (option for BD)	30
8.5 Analog output for temperature (option).....	30
8.6 Water protected internal socket (option for BD).....	31
9. MAINTENANCE, CLEANING, AND SERVICE	32
9.1 Maintenance intervals, service.....	32
9.2 Cleaning and decontamination	32
9.2.1 Cleaning.....	33
9.2.2 Decontamination	34
9.3 Sending the chamber back to BINDER GmbH	35
10. DISPOSAL.....	36
10.1 Disposal of the transport packing.....	36
10.2 Decommissioning.....	36
10.3 Disposal of the chamber in the Federal Republic of Germany	36
10.4 Disposal of the chamber in the member states of the EU except for the Federal Republic of Germany.....	37
10.5 Disposal of the chamber in non-member states of the EU	38
11. TROUBLESHOOTING	39
12. TECHNICAL DESCRIPTION.....	40
12.1 Factory calibration and adjustment	40
12.2 Definition of usable volume	40
12.3 Over current protection	40
12.4 BD technical data	41
12.5 ED technical data	42
12.6 FD technical data	44
12.7 Equipment and options BD (extract)	47
12.8 Equipment and options ED (extract)	48
12.9 Equipment and options FD (extract)	49
12.10 Accessories and spare parts (extract)	50
13. CERTIFICATES AND DECLARATIONS OF CONFORMITY.....	51
13.1 EU Declaration of Conformity for BD	51
13.2 EU Declaration of Conformity for ED	54
13.3 EU Declaration of Conformity for FD	57
13.4 Certificate for the GS mark of conformity of the “Deutsche Gesetzliche Unfallversicherung e.V.” (German Social Accident Insurance) DGUV	60
14. PRODUCT REGISTRATION	62
15. CONTAMINATION CLEARANCE CERTIFICATE	63
15.1 For chambers located outside the USA and Canada	63
15.2 For chambers located in the USA and Canada	66



Dear customer,

For the correct operation of the chambers, it is important that you read this operating manual completely and carefully and observe all instructions as indicated. Failure to read, understand and follow the instructions may result in personal injury. It can also lead to damage to the chamber and/or poor equipment performance.

Understanding and observing the instructions in this operating manual are prerequisites for hazard-free use and safety during operation and maintenance. In no event shall BINDER be held liable for any damages, direct or incidental arising out of or related to the use of this manual.

1. Safety

This operating manual is part of the components of delivery. Always keep it handy for reference. The device should only be operated by laboratory personnel especially trained for this purpose and familiar with all precautionary measures required for working in a laboratory. Observe the national regulations on minimum age of laboratory personnel To avoid injuries and damage observe the safety instructions of the operating manual.

	 WARNING
	<p>Failure to observe the safety instructions. Serious injuries and chamber damage.</p> <ul style="list-style-type: none"> ➤ Observe the safety instructions in this operating manual ➤ Carefully read the complete operating instructions of the chamber.

1.1 Legal considerations

This operating manual is for informational purposes only. It contains information for installing, start-up, operation and maintenance of the product. Note: the contents and the product described are subject to change without notice.

Understanding and observing the instructions in this operating manual are prerequisites for hazard-free use and safety during operation and maintenance. In no event shall BINDER be held liable for any damages, direct or incidental arising out of or related to the use of this manual.

This operating manual cannot cover all conceivable applications. If you would like additional information, or if special problems arise that are not sufficiently addressed in this manual, please ask your dealer or contact us directly by phone at the number located on page one of this manual

Furthermore, we emphasize that the contents of this operating manual are not part of an earlier or existing agreement, description, or legal relationship, nor do they modify such a relationship. All obligations on the part of BINDER derive from the respective purchase contract, which also contains the entire and exclusively valid statement of warranty administration. The statements in this manual neither augment nor restrict the contractual warranty provisions.

1.2 Structure of the safety instructions

In this operating manual, the following safety definitions and symbols indicate dangerous situations following the harmonization of ISO 3864-2 and ANSI Z535.6.

1.2.1 Signal word panel

Depending on the probability of serious consequences, potential dangers are identified with a signal word, the corresponding safety color, and if appropriate, the safety alert symbol.

 DANGER
<p>Indicates an imminently hazardous situation that, if not avoided, will result in death or serious (irreversible) injury.</p>

WARNING

Indicates a potentially hazardous situation which, if not avoided, could result in death or serious (irreversible) injury

CAUTION

Indicates a potentially hazardous situation which, if not avoided, may result in moderate or minor (reversible) injury

CAUTION

Indicates a potentially hazardous situation which, if not avoided, may result in damage to the product and/or its functions or of a property in its proximity.

1.2.2 Safety alert symbol





Use of the safety alert symbol indicates a **risk of injury**.

Observe all measures that are marked with the safety alert symbol in order to avoid death or injury.

1.2.3 Pictograms

Warning signs			
Electrical hazard	Hot surface	Explosive atmosphere	Stability hazard
Lifting hazard	Risk of corrosion and / or chemical burns	Harmful substances	Biohazard
Pollution Hazard			
Mandatory action signs			
Mandatory regulation	Read operating instructions	Disconnect the power plug	Lift with several persons
Lift with mechanical assistance	Environment protection	Wear protective gloves	Wear safety goggles

Prohibition signs			
 Do NOT touch	 Do NOT spray with water		

	Information to be observed in order to ensure optimum function of the product.
---	---



1.2.4 Word message panel structure

<p>Type / cause of hazard.</p> <p>Possible consequences.</p> <p>∅ Instruction how to avoid the hazard: prohibition.</p> <p>➤ Instruction how to avoid the hazard: mandatory action.</p>

Observe all other notes and information not necessarily emphasized in the same way, in order to avoid disruptions that could result in direct or indirect injury or property damage.

1.3 Localization / position of safety labels on the chamber

The following labels are located on the chamber:

Pictograms (Warning signs)		Service label
	Hot surface <ul style="list-style-type: none"> • ED, FD: outer chamber door • BD: inner glass door next to the glass door handle • On chamber rear next to the exhaust duct 	
	Read operating manual <ul style="list-style-type: none"> • UL chambers: outer chamber door • BD with optional interior socket: below the interior socket 	

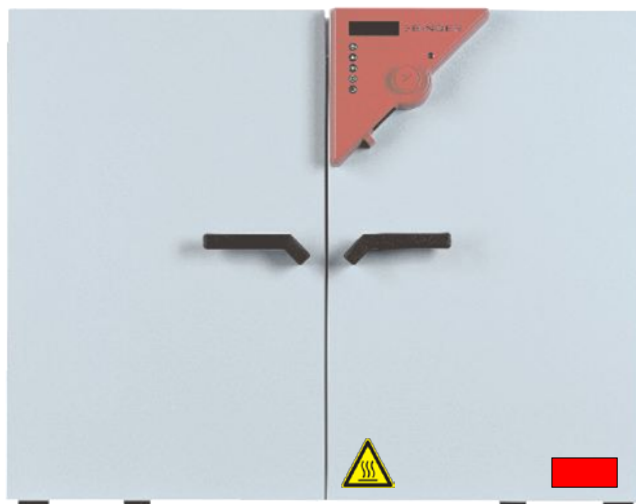
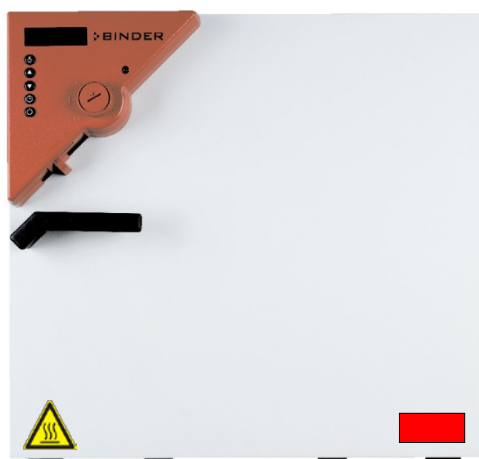

Figure 1: Position of labels on the chamber on the front (example: ED, FD)



Keep safety labels complete and legible.

Replace safety labels that are no longer legible. Contact BINDER Service for these replacements.

1.4 Type plate

The type plate is located on the left-hand side of the chamber (size 23) or on the chamber front behind the door, bottom left-hand.







Figure 2: Type plate (example: FD 115 regular chamber)



Figure 3: Type plate (example: BD 53 optional chamber)

Indications of the type plate (example)		Information
BINDER		Manufacturer: BINDER GmbH
FD 115		Model designation
Incubator		Device name: Incubator
Drying and heating oven		Device name: Drying and heating oven
Serial No.	000000000000	Serial No.
Built	2019	Year of construction
Nominal temperature	100 °C 212 °F	Nominal temperature
IP protection	20	IP type of protection acc. to EN 60529
Temp. safety device	DIN 12880	Temperature safety device acc. to standard DIN 12880:2007
Class	3.1	Class of temperature safety device
Art. No.	9110-0081	Art. no. of the chamber
Project No.	---	Optional: Special application acc. to project no.

Indications of the type plate (example)	Information
0,40 kW	Nominal power
1,8 A	Nominal current
230 V / 50 Hz	Nominal voltage +/-10% at the indicated power frequency
230 V / 60 Hz	
1 N ~	Current type
With option internal socket: Nominal power: 0,90 kW	With option internal socket: increased total nominal power

Symbol on the type plate	Information
	CE conformity marking
	Electrical and electronic equipment manufactured / placed on the market in the EU after 13 August 2005 and to be disposed of in a separate collection according to directive 2012/19/EU on waste electrical and electronic equipment (WEEE).
	The chamber is certified according to Customs Union Technical Regulation (CU TR) for the Eurasian Economic Union (Russia, Belarus, Armenia, Kazakhstan Kyrgyzstan).
	GS mark of conformity of the "Deutsche Gesetzliche Unfallversicherung e.V. (DGUV), Prüf- und Zertifizierungsstelle Nahrungsmittel und Verpackung im DGUV Test" (German Social Accident Insurance (DGUV), Testing and Certification Body for Foodstuffs and Packaging Industry in DGUV Test). Not valid for UL chambers
 (UL chamber only)	The chamber is certified by Underwriters Laboratories Inc.® according to the following standards: UL 61010A-1, 1 st Edition, UL 61010A-2-10, 1 st Edition CSA C22.2 No. 1010.1-92, IEC 1010-2-10

1.5 General safety instructions on installing and operating the chambers



With regard to operating the chambers and to the installation location, please observe the DGUV guidelines 213-850 on safe working in laboratories (formerly BGI/GUV-I 850-0, BGR/GUV-R 120 or ZH 1/119, issued by the employers' liability insurance association) (for Germany).

BINDER GmbH is only responsible for the safety features of the chamber provided skilled electricians or qualified personnel authorized by BINDER perform all maintenance and repair, and if components relating to chamber safety are replaced in the event of failure with original spare parts.



To operate the chamber, use only original BINDER accessories or accessories from third-party suppliers authorized by BINDER. The user is responsible for any risk caused by using unauthorized accessories.

CAUTION	
	<p>Danger of overheating. Damage to the chamber.</p> <ul style="list-style-type: none"> ⊘ Do NOT install the chamber in unventilated recesses. ➤ Ensure sufficient ventilation for dispersal of the heat.

Do not operate the chambers in hazardous locations.

	 DANGER
	<p>Explosion hazard. Danger of death.</p> <ul style="list-style-type: none"> ⊘ Do NOT operate the chamber in potentially explosive areas. ➤ KEEP explosive dust or air-solvent mixtures AWAY from the chamber.

The chambers do not dispose of any measures of explosion protection.

	 DANGER
	<p>Explosion hazard. Danger of death.</p> <ul style="list-style-type: none"> ⊘ Do NOT introduce any substance into the chamber which is combustible or explosive at working temperature. ⊘ NO explosive dust or air-solvent mixture in the inner chamber.



Any solvent contained in the charging material must not be explosive or inflammable. I.e., irrespective of the solvent concentration in the steam room, NO explosive mixture with air must form. The temperature inside the chamber must lie below the flash point or below the sublimation point of the charging material. Familiarize yourself with the physical and chemical properties of the charging material, as well as the contained moisture constituent and its behavior with the addition of heat energy.

Familiarize yourself with any potential health risks caused by the charging material, the contained moisture constituent or by reaction products that may arise during the temperature process. Take adequate measures to exclude such risks prior to putting the chamber into operation.

	 DANGER
	<p>Electrical hazard. Danger of death.</p> <ul style="list-style-type: none"> ⊘ The chamber must NOT become wet during operation or maintenance.

The chambers were produced in accordance with VDE regulations and were routinely tested in accordance to VDE 0411-1 (IEC 61010-1).

During and shortly after operation, the temperature of the inner surfaces almost equals the set-point.

	 CAUTION
	<p>The glass doors and glass door handles (BD), inner chamber, exhaust duct, door window (option), and the door gaskets will become hot during operation.</p> <p>Danger of burning.</p> <ul style="list-style-type: none"> ⊘ Do NOT touch the glass doors, inner surfaces, exhaust duct, door window, access ports, door gaskets, or the charging material during operation.

1.6 Intended use

The chambers are suitable for exact tempering of harmless materials and for drying and heat treatment of solid or pulverized charging material, as well as bulk material, using the supply of heat. They can be used to dry e.g. glassware, and for warm storage of liquids in containers.

Because of their precise temperature accuracy the incubators BD are especially useful for incubation of cultures at a standard temperature of 37 °C / 98.6 °F.

A solvent content must not be explosive or flammable. A mixture of any component of the charging material with air must NOT be explosive. The operating temperature must lie below the flash point or below the sublimation point of the charging material. Any component of the charging material must NOT be able to release toxic gases

Other applications are not approved.

The chambers are not classified as medical devices as defined by the Medical Device Directive 93/42/EEC.

Do NOT use the chamber for drying processes when large quantities of vapor would form and result in condensation.



Due to the special demands of the Medical Device Directive 93/42/EEC, these chambers are not qualified for sterilization of medical devices as defined by the directive.



Observing the instructions in this operating manual and conducting regular maintenance work (chap. 9) is part of the intended use.





WARNING: If customer should use a BINDER chamber running in non-supervised continuous operation, we strongly recommend in case of inclusion of irrecoverable specimen or samples to split such specimen or samples and store them in at least two chambers, if this is feasible.



The charging material shall not contain any corrosive ingredients that may damage the machine components. Such ingredients include in particular acids and halides. Any corrosive damage caused by such ingredients is excluded from liability by BINDER GmbH.

The chambers do not dispose of any measures of explosion protection.

 	 DANGER
	<p>Explosion or implosion hazard. Danger of poisoning. Danger of death.</p> <ul style="list-style-type: none"> ⊘ Do NOT introduce any substance combustible or explosive at working temperature into the chamber, in particular no energy sources such as batteries or lithium-ion batteries. ⊘ NO explosive dust or air-solvent mixture in the inner chamber. ⊘ Do NOT introduce any substance which could lead to release of toxic gases.

In case of foreseeable use of the device there is no risk for the user through the integration of the chamber into systems or by special environmental or operating conditions in the sense of EN 61010-1:2010. For this, the intended use of the chamber and all its connections must be observed.

1.7 Operating instructions

Depending on the application and location of the chamber, the operator of the chamber must provide the relevant information for safe operation of the chamber in a set of operating instructions.



Keep these operating instructions with the chamber at all times in a place where they are clearly visible. They must be comprehensible and written in the language of the employees.

1.8 Measures to prevent accidents

The manufacturer took the following measures to prevent ignition and explosions:

- **Indications on the type plate**
See operating manual chap. 1.4.
- **Operating manual**
An operating manual is available for each chamber.
- **Overtemperature monitoring**
The chamber is equipped with a temperature display, which can be read from outside.
The chamber is equipped with an additional safety controller (temperature safety device class 3.1 (BD) or class 2 (ED, FED) acc. to DIN 12880:2007). Visual and audible (buzzer) signals indicate temperature exceeding.
- **Safety, measurement, and control equipment**
The safety, measuring, and control equipment is easily accessible.
- **Electrostatic charge**
The interior parts are grounded.
- **Non-ionizing radiation**
Non-ionizing radiation is not intentionally produced, but released only for technical reasons by electrical equipment (e.g. electric motors, power cables, solenoids). The machine has no permanent magnets. If persons with active implants (e.g. pacemakers, defibrillators) keep a safe distance (distance of field source to implant) of 30 cm, an influence of these implants can be excluded with high probability.
- **Protection against touchable surfaces**
Tested according to EN ISO 13732-1:2008.
- **Floors**
See operating manual chap. 3.4 for correct installation
- **Cleaning**
See operating manual chap. 9.2.
- **Examinations**
The chamber has been inspected by the "Deutsche Gesetzliche Unfallversicherung e.V. (DGUV) (German Social Accident Insurance (DGUV)" (German Social Accident Insurance (DGUV), Testing and Certification Body for Foodstuffs and Packaging Industry in DGUV Test) and bears the GS mark. (Not valid for UL chambers)

UL chambers only: The chamber is certified by Underwriters Laboratories Inc.® according to the standards UL 61010A-1, 1st Edition, UL 61010A-2-10, 1st Edition, CSA C22.2 No. 1010.1-92, IEC 1010-2-10.

2. Chamber description

BINDER incubators BD and drying and heating ovens ED and FD are equipped with an electronic PID-controller with digital display.



The incubators BD indicate the temperature with an accuracy of a tenth of a degree.
The drying and heating ovens ED and FD indicate the temperature with an accuracy of one degree.

The chambers are heated electrically. Incubators BD and drying and heating ovens ED are ventilated naturally. Drying and heating ovens FD are ventilated by fan-assisted, forced-air circulation.

The APT.line™ preheating chamber system guarantees high level of spatial and time-based temperature precision, thanks to the direct and distributed air circulation into the interior. With FD, the fan supports exact attainment and maintenance of the desired temperature accuracy.

The chambers are regularly equipped with a temperature safety device according to DIN12880:2007 (chap. 7).

The inner chamber, the pre-heating chamber and the inside of the doors are all made of stainless steel V2A (German material no. 1.4301, US equivalent AISI 304). When operating the drying and heating ovens ED and FD at temperatures above 150 °C / 302 °F, the impact of the oxygen in the air may cause discoloration of the metallic surfaces (yellowish-brown or blue) by natural oxidation processes. These colorations are harmless and will in no way impair the function or quality of the chamber. The housing is RAL 7035 powder-coated. All corners and edges are also completely coated.

All chamber functions are easy and comfortable to use thanks to their clear arrangement. Major features are easy cleaning of all chamber parts and avoidance of undesired contamination.

BINDER incubators BD and drying and heating ovens ED (option) are equipped with a serial interface RS 422 for computer communication, e.g. via the APT-COM™ 4 Multi Management Software (option, chap. 8.2). For further options, see chap. 12.7 to 12.9.

The models size 720 are equipped with four castors. Both front castors can be locked by brakes.

Temperature range at an ambient temperature of +18 °C up to +40 °C / 64.4 °F to 104 °F.

- Incubators BD: 5 °C / 9 °F above room temperature up to 100 °C / 212 °F.
- Drying and heating ovens ED and FD: 5 °C / 9 °F above room temperature up to 300 °C / 572 °F.

2.1 Chamber overview

- (1) Display
- (2) Set-point value key
- (3) Selector keys
- (4) Time management key
- (5) Switch ON/OFF
- (6) Lever for ventilation slide
- (7) Safety device
- (8) Door handle
- (9) **BD**: ON/OFF switch for internal socket (option)
ED / FD: Switch for interior lighting (option) **or** buzzer switch for audible over-temperature alarm (option)
- (10) **BD**: Buzzer switch for audible over-temperature alarm (option)
ED: Main power switch with sizes 400 and 720

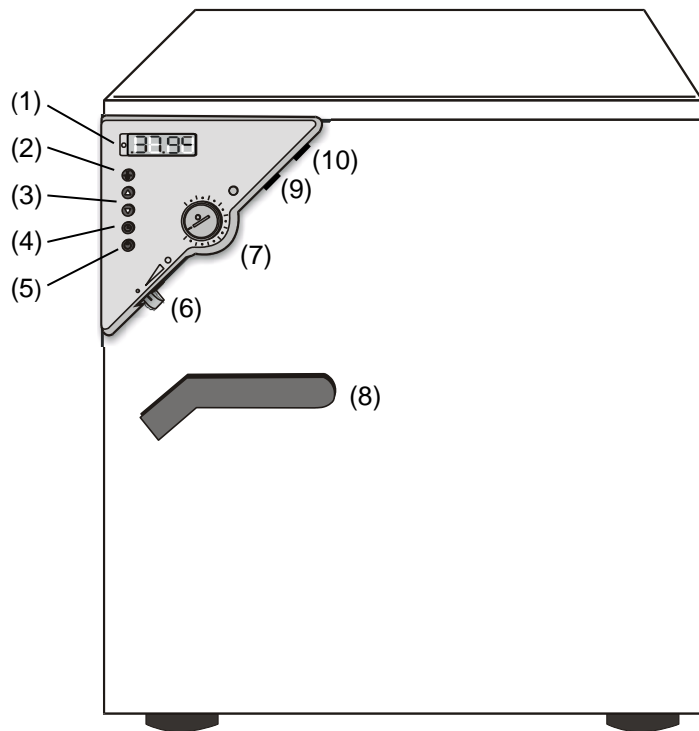

Figure 4: Overview BD / ED / FD



3. Completeness of delivery, transportation, storage, and installation

3.1 Unpacking, and checking equipment and completeness of delivery

After unpacking, please check the chamber and its optional accessories, if any, based on the delivery receipt for completeness and for transportation damage. Inform the carrier immediately if transportation damage has occurred.

The final tests of the manufacturer may have caused traces of the racks on the inner surfaces. This has no impact on the function and performance of the chamber.

Please remove any transportation protection devices and adhesives in/on the chamber and on the doors and take out the operating manuals and accessory equipment.

	 CAUTION
	<p>Sliding or tilting of the chamber. Damage to the chamber. Risk of injury by lifting heavy loads.</p> <ul style="list-style-type: none"> ⊘ Do NOT lift or transport the chamber using the door handle or the door. ⊘ Do NOT lift chambers size 400 and 720 by hand ➤ Lift chambers size 23, 53, 115 from the pallet at its four lower corners with the aid of 2 people, chamber size 240 with the aid of 4 people. ➤ Lift chambers size 400 and 720 from the pallet using technical devices (fork lifter). Set the fork lifter only from the rear in the middle of the chamber. Make sure to place all the lateral supports of the chamber on the forks.

If you need to return the chamber, please use the original packing and observe the guidelines for safe lifting and transportation (chap. 3.2).

For disposal of the transport packing, see chap. 10.1.



Note on second-hand chambers (Ex-Demo chambers):

Second-hand chambers are chambers that have been used for a short time for tests or exhibitions. They are thoroughly tested before resale. BINDER ensures that the chamber is technically sound and will work flawlessly.

Second-hand chambers are marked with a sticker on the chamber door. Please remove the sticker before commissioning the chamber.

3.2 Guidelines for safe lifting and transportation

The front castors of chambers size 720 can be blocked by brakes. Please move the chambers with castors only when empty and on an even surface, otherwise the castors may be damaged. After operation please observe the guidelines for temporarily decommissioning the chamber (chap. 10.2).

	 CAUTION
<p>Sliding or tilting of the chamber. Damage to the chamber. Risk of injury by lifting heavy loads.</p> <ul style="list-style-type: none"> ➤ Transport the chamber only in its original packaging. ➤ Secure the chamber with transport straps for transport. ⊘ Do NOT lift or transport the chamber using the door handle or the door. ⊘ Do NOT lift chambers size 400 and 720 by hand. ➤ Lift chambers size 23, 53, 115 at its four lower corners with the aid of 2 people, chamber size 240 with the aid of 4 people, and place it on a transport pallet with wheels. Push the pallet to the desired site and then lift the chamber from the pallet at its four lower corners. ➤ Place chambers size 400 and 720 using technical devices (fork lifter) on the transport pallet. Set the fork lifter only from the rear in the middle of the chamber. Make sure to place all the lateral supports of the chamber on the forks. ➤ Transport chambers size 400 and 720 ONLY with the original transport pallet. Set the fork lifter only to the pallet. Without the pallet the chamber is in imminent danger of overturning!! 	

- Permissible ambient temperature range during transport: -10 °C to +60 °C / 14 °F to 140 °F.

You can order transport packing and pallets for transportation purposes from BINDER Service.

3.3 Storage

Intermediate storage of the chamber is possible in a closed and dry room. Observe the guidelines for temporary decommissioning (chap. 10.2).

- Permissible ambient temperature range during storage: -10 °C to +60 °C / 14 °F to 140 °F.
- Permissible ambient humidity: max. 70 % r.H., non-condensing

When after storage in a cold location you transfer the chamber to its warmer installation site, condensation may form. Before start-up, wait at least one hour until the chamber has attained ambient temperature and is completely dry.

3.4 Location of installation and ambient conditions

Set up the chamber on an even and non-flammable surface, free from vibration and in a well-ventilated, dry location and align it using a spirit level. The site of installation must be capable of supporting the chamber's weight (see technical data, chap. 12.4 to 12.6). The chambers are designed for setting up inside a building (indoor use).

	CAUTION
	<p>Danger of overheating. Damage to the chamber.</p> <ul style="list-style-type: none"> ⊘ Do NOT set up the chamber in non-ventilated recesses. ➤ Ensure sufficient ventilation for dispersal of the heat.

- Permissible ambient temperature range during operation: +18 °C up to +40 °C / 64.4 °F to 104 °F.
- At elevated ambient temperature values, fluctuations in temperature can occur.

	<p>The ambient temperature should not be substantially higher than the indicated ambient temperature of +25 °C / 77 °F to which the specified technical data relate. For other ambient conditions, deviations from the indicated data are possible.</p>
---	---

- Permissible ambient humidity: 70 % r.H. max., non-condensing.
- Installation height: max. 3000 m / 9842 ft. above sea level.

When placing several chambers of the same size side by side, maintain a minimum distance of 250 mm / 9.84 in between each chamber. Wall distances: rear 100 mm / 3.94 in, sides 160 mm / 6.30 in. Spacing above the chamber of at least 100 mm / 3.94 in must also be accounted for.



Two chambers up to size 115 can be stacked on top of each other. For this purpose place rubber pads under all four feet of the upper chamber to prevent the device from slipping.

	CAUTION
	<p>Sliding or tilting of the upper chamber. Damage to the chambers.</p> <ul style="list-style-type: none"> ➤ When stacking, place rubber pads under all four feet of the upper chamber.

To completely separate the chamber from the power supply, you must disconnect the power plug. Install the chamber in a way that the power plug is easily accessible and can be easily pulled in case of danger.

For the user there is no risk of temporary overvoltages in the sense of EN 61010-1:2010.

Do not install or operate the chamber in potentially explosive areas.

	 DANGER
	<p>Explosion hazard. Danger of death.</p> <ul style="list-style-type: none"> ⊘ Do NOT operate the chamber in potentially explosive areas. ➤ KEEP explosive dust or air-solvent mixtures AWAY from the vicinity of the chamber.

4. Installation of the equipment

4.1 Electrical connection

The chambers are supplied ready for connection. They come with a fixed power connection cable of at least 1800 mm / 70.87 in in length.

Model	Power plug	Nominal voltage $\pm 10\%$ at the indicated power frequency	Current type
BD all sizes ED 23 / 53 / 115 / 240 FD all sizes	Grounded plug	230 V at 50 Hz 230 V at 60 Hz	1N~
ED 400 / 720	CEE plug 5 poles	400 V at 50 Hz 400 V at 60 Hz	3N~
BD 23-UL / 53-UL / 115-UL / 240-UL / 400-UL ED 23-UL FD 23-UL	NEMA 5-15P	115 V at 60 Hz	1N~
BD 720-UL ED 53-UL / 115-UL FD 53-UL / 115-UL	NEMA- 5-20P	115 V at 60 Hz	1N~
ED 240-UL / 400-UL / 720-UL FD 240-UL	NEMA L21-20P	208 V at 60 Hz	3N~

- The domestic socket must also provide a protective conductor. Make sure that the connection of the protective conductor of the domestic installations to the chamber's protective conductor meets the latest technology. The protective conductors of the socket and plug must be compatible!
- Prior to connection and start-up, check the power supply voltage. Compare the values to the specified data located on the chamber's type plate (chamber front behind the door bottom left-hand, or on the left-hand side of the chamber, chap. 1.4).
- When connecting, please observe the regulations specified by the local electricity supply company and as well as the VDE directives (for Germany). We recommend the use of a residual current circuit breaker.
- Pollution degree (acc. to IEC 61010-1): 2
- Over-voltage category (acc. to IEC 61010-1): II

	CAUTION
	<p>Danger of incorrect power supply voltage. Damage to the equipment.</p> <ul style="list-style-type: none"> ➤ Check the power supply voltage before connection and start-up. ➤ Compare the power supply voltage with the data indicated on the type plate.



See also electrical data (chap. 12.4 to 12.6).

	<p>To completely separate the chamber from the power supply, you must disconnect the power plug. Install the chamber in a way that the power plug is easily accessible and can be easily pulled in case of danger.</p>
---	--

4.2 Connection to a suction plant (optional)

When directly connecting a suction plant; the spatial temperature exactitude, the heating-up times, the recovering times, and the maximum temperature will be negatively influenced. So no suction plant should be directly connected to the exhaust duct.

	Active suction from the chamber must only be effected together with extraneous air. Perforate the connecting piece to the suction device or place an exhaust funnel at some distance to the exhaust duct.
---	---

	<div style="background-color: yellow; text-align: center; padding: 5px;"> CAUTION</div> <p>The exhaust duct will become hot during operation. Danger of burning. ∅ Do NOT touch the exhaust duct during operation.</p>
---	--

5. Start up

5.1 Turning on the chamber

	Warming chambers may release odors in the first few days after commissioning. This is not a quality defect. To reduce odors quickly we recommend heating up the chamber to its nominal temperature for one day and in a well-ventilated location.
--	---

1. Insert the plug into a suitable socket (chap. 4.1).
2. Turn on ED chambers sizes 400 and 720 at the main power switch (10)

The green "Standby" LED illuminates



3. Press  until the display lights up.

The controller is now in normal display (actual value display).

If the chamber is operating (time functions "Continuous operation", or "Timer operation" with the set time just running down chap. 6.3), the **actual temperature value** (example: 22 °C) is displayed



If the controller is in time function "Timer operation" with no time programmed or the set time run-off (chap. 6.3), the chamber is inactive (no heating). The display alternately shows the **actual temperature value** (example: 22 °C) and "tOff":

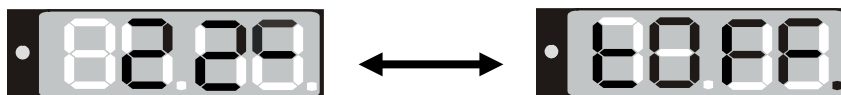

	Adjust the safety device following any changes of the set-point (chap. 7).
---	--

5.2 Heating operation display

The heating and fan (with FD) are active as soon as the red heating control light in the bottom right corner of the display slowly begins to flash depending on the heat requirement (example: 70 °C).



5.3 Air change

Opening the air flap in the exhaust duct serves to adjust the air change.

Without connecting a suction plant:

- For BD and ED chambers fresh air circulation can be elevated using the exhaust duct. The air flap in the exhaust duct serves to adjust the fresh air entry.
- For FD chambers with the air flap open and the fan operating, fresh air comes in via aeration gaps.
- If the air flap is completely open, the spatial temperature accuracy can be negatively influenced.

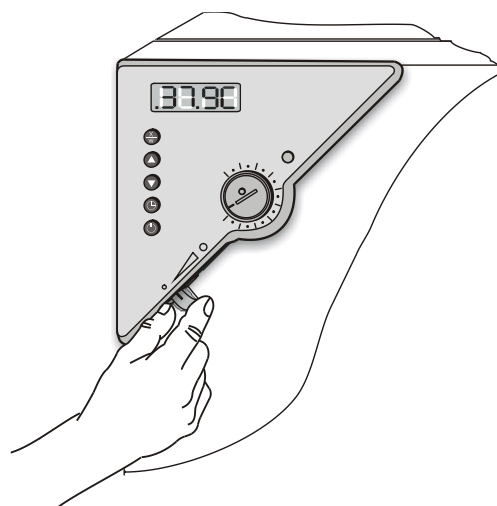

Figure 5: Adjusting the air flap

6. Operating the controller

Controller setting is identical with all three chambers BD, ED, and FD. The temperature controllers only differ in their temperature range (BD: up to 100 °C / 212 °F, ED/FD: up to 300 °C / 572 °F) and the displayed accuracy (BD: a tenth of a degree, ED/FD: one degree).

6.1 Display / entry of temperature set-point (without ramp function)

The chamber is operating, the controller is in normal display (actual value display). The actual temperature value (example: 22 °C) is displayed:



1. Press button

The display shows alternately "SP" and the previous **temperature set-point** (example: 60 °C):



2. With the buttons enter a set-point value between 0 and 300.

The desired temperature set-point can be selected in a temperature range from 5 °C / 9 °F above room temperature up to 100 °C / 212 °F (BD) or 300 °C / 572 °F (ED/FD).

3. Wait 2 seconds until the entered temperature value is taken over (display flashing once).

4. Press button to return to normal display (actual value display) (automatically after approx. 30 seconds).

Adjust the safety device following any changes of the set-point (chap. 7).

6.2 Display / entry of temperature set-point (with selected temperature ramp)

If previously a temperature ramp value has been selected (chap. 6.4.2):

Press button  in normal display / actual value display during ramp operation to have displayed the actual temperature ramp set-point, which changes according to the selected gradient, in addition to the entered target set-point for temperature.

The chamber is operating, the controller is in normal display (actual value display). The **actual temperature value** (example: 22 °C) is displayed:



1. Press  button

The display shows alternately "SPr" and the **actual temperature ramp set-point** changing according to the selected gradient (example: 42 °C):





This ramp set-point is displayed only, it is not adjustable.

2. Press  button

The display shows alternately "SP" and the previous **temperature set-point** (example: 60 °C):



3. With the   buttons enter a set-point value between 0 and 300.



The desired temperature set-point can be selected in a temperature range from 5 °C / 9 °F above room temperature up to 100 °C / 212 °F (BD) or 300 °C / 572 °F (ED/FD).

4. Wait 2 seconds until the entered temperature value is taken over (display flashing once).

5. Press  button to return to normal display / actual value display (automatically after approx. 30 seconds).



Adjust the safety device following any changes of the set-point (chap. 7).

6.3 Time functions: Continuous operation and Timer operation

Press the time management button .

The timer indicates its current time function. There are two possible time functions:

Continuous operation

The display shows alternately "t1" (time function) and the time function "Continuous operation" "t inf":

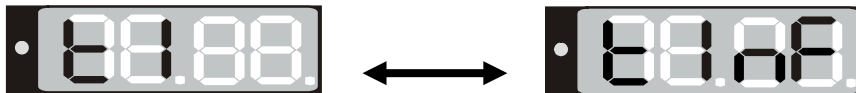

The heating and fan (with FD) are permanently active, independent of the timer setting.

Timer operation

The display shows alternately "t1" (time function) and the running-down time or "tOff":

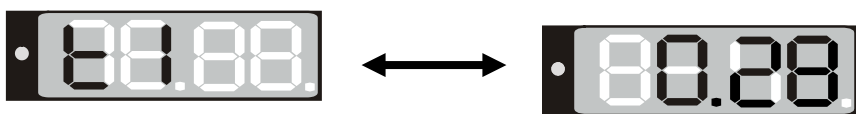

or

Remaining time (example: 28 Min.) – **Timer running down**

Heating and fan (with FD) are active until the timer has run-down.



Timer not programmed or run-down "t off"

If the timer has run-down, heating and fan (with FD) are permanently off.

Press  button to return to normal display (actual value display) (automatically after approx. 30 seconds).

6.3.1 Switching between “Continuous operation” and “Timer operation”

Press the time management button .

The controller displays the actual time function. In time function “Continuous operation”, “t1” and “t inf” are displayed alternately. In time function “Timer operation”, “t1” is displayed alternately with the running-down time or “tOff”.

If in time function “Timer operation” the Timer is just running off (“t1” displayed alternately with the running-down time) the timer must first be set to Zero (chap. 6.3.3). Now “t1” is displayed alternately with “tOff”, and the controller can be changed to time function “Continuous operation”.

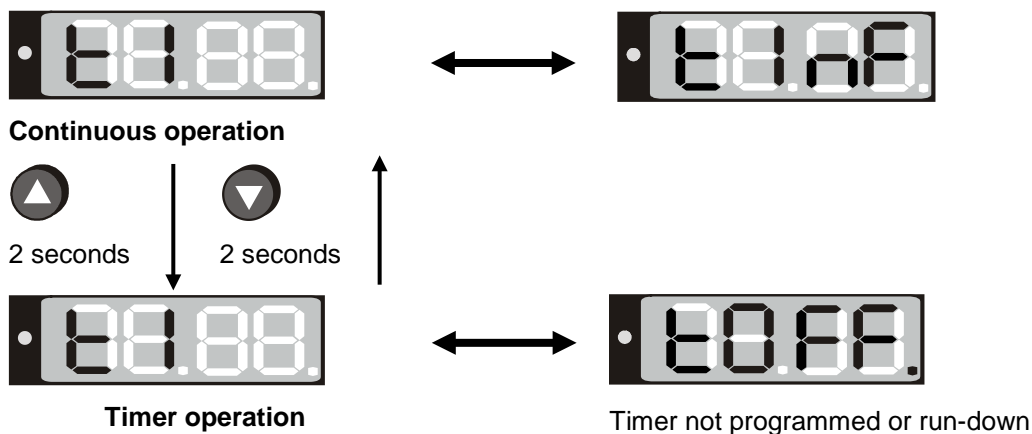

Press  button to return to normal display / actual value display (automatically after approx. 30 sec).

6.3.2 Continuous operation

1. Press the time management button . The timer indicates its current time function.

2. If necessary, switch to timer operation by button .

The display shows alternately “t1” and the time function “Continuous operation” “t inf”:

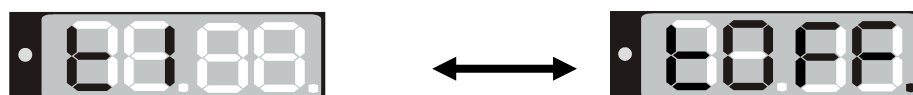

3. Press  button to return to normal display (actual value display) (automatically after approx. 30 seconds).

The **actual temperature value** (example: 22 °C) is displayed:



Now the controller operates with the entered set-point (chap. 6.1) in continuous operation. The heating and fan (for FD) are permanently active, independent of the timer setting.

To cancel Continuous operation, proceed accordingly:

1. Press the time management button .

2. Switch to Timer operation by pressing down button  for 2 seconds (chap. 6.3.1).

6.3.3 Timer operation: Setting the tempering time

1. Press the time management button . The controller indicates its current time function.

2. If necessary, switch to timer operation by button .

The display alternately shows "t1" and the running-down time or "tOff":

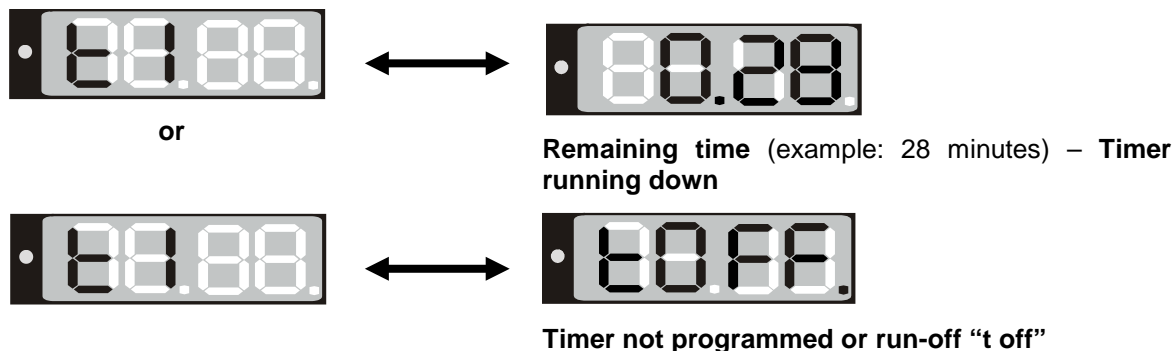

3. Set the desired time [hh.mm] with buttons  .

4. Wait 2 seconds until the entered temperature value is taken over (display flashing once).

The display alternately shows "t1" and the set time now running down.

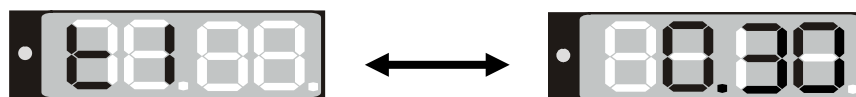

The time directly begins to run off after taking-over of the entered value. Heating and fan (with FD) are active until the timer has run-down.

5. Press button  to return to normal display (actual value display) (automatically after approx. 30 seconds).

The **actual temperature value** is displayed (example: 22 °C):



The controller operates with the entered set-points (chap. 6.1) until run-down of the set time. Heating and fan (with FD) are active until the timer has run-down.

To know the remaining timer time or, if appropriate, to modify it, press the time management button  in normal display (actual value display).

The display alternately shows "t1" and the running-down time:

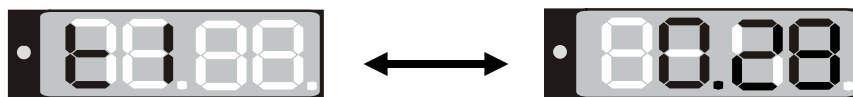

After the set time has run down the display alternately shows the **actual temperature value** (example: 22 °C) and "tOff":

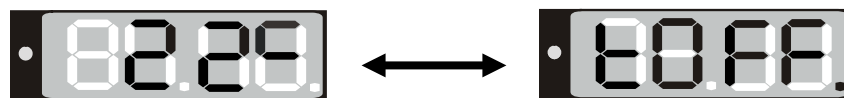

Now the heating and fan (with FD) are inactive.

6.4 User level settings

By pressing down button  in normal display (actual value display) for 5 sec, you enter the user menu. Settings in this menu affect controller operation.

User level overview:

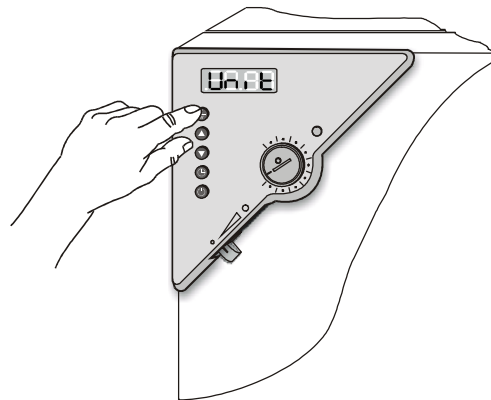
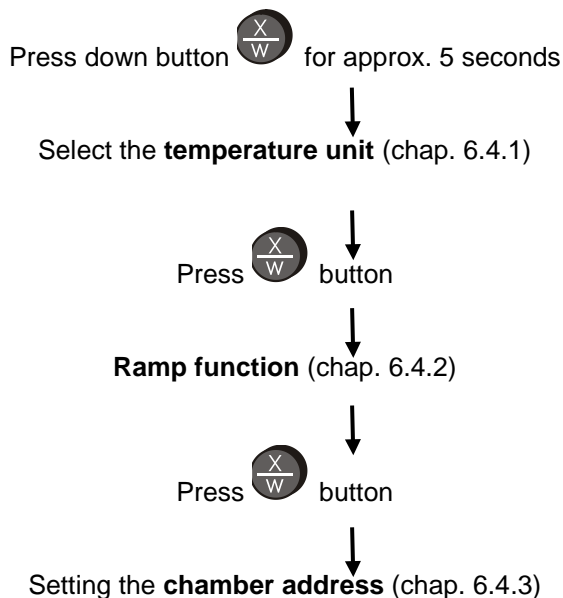



Figure 6: Press down  button for approx. 5 seconds

Press button  to return to normal display with display of the temperature set-point. **Or:**

After approx. 30 seconds the controller automatically returns to normal display / actual value display.

All settings can be carried out independently (as described in the individual sections) or one after the other during one single process.



The defined parameters are not deleted when the main power switch is turned off or in case of power failure.



6.4.1 Temperature unit change between degrees Celsius °C and degrees Fahrenheit °F

If required, the temperature display can be changed as follows:

1. Press down  button for approx. 5 seconds.

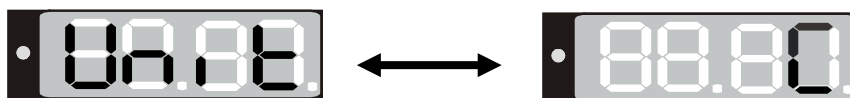
The display alternately shows "unit" and the actual setting of the **temperature unit**:



2. Use the   buttons to set the required unit.
3. The set unit is automatically adopted after 2 seconds.



C = degrees Celsius	0 °C = 32 °F	Conversion: [Value in °F] = [Value in °C] * 1.8 + 32
F = degrees Fahrenheit	100 °C = 212 °F	

When specifying the set point ramp (see chap. 6.4.2) this setting is accordingly taken as the basis.



If the unit is changed, the temperature set-point and limits are converted accordingly.

6.4.2 Entering a temperature ramp

You can program temperature ramps in order to extend heating up times. This may be necessary in some cases to prevent temperature stresses in the material during the heating up phase. Temperature ramps should only be used if required. Using them may result in considerably slowing down the heating up times.

The entry in °C/min or in °F/min means the nominal value gradient and limits the maximum temperature increase to this value. Due to the heat and evaporation energy assumed by the drying material, smaller temperature gradients may also result.

A temperature ramp proceeds from a previously entered set-point to a new one. The temperature must be equilibrated to the start set-point. Perform the setting in the following 3 steps:

1. Enter the set-point of the ramp start temperature. Let the temperature equilibrate to this value.
2. Set the ramp to the desired gradient. You can select a gradient from 0.0 °C/min up to 1.0 °C/min (BD), resp. from 1 °C/min up to 10 °C/min (ED, FD).

A heating-up rate of 0.4 °C/min (BD) resp. 4 °C/min (ED, FD) can be regarded as a realistic maximum.

3. Enter the set-point (target ramp temperature).

Set a ramp gradient only if required. The setting "0" means "ramp function turned off". The chamber will heat up with its maximum heating capacity.

1. Press down  button for approx. 5 seconds.

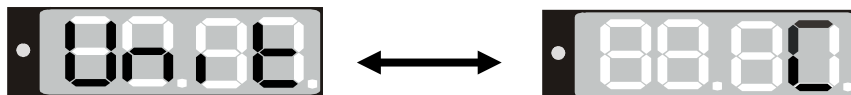

The display alternately shows "unit" and the temperature unit:

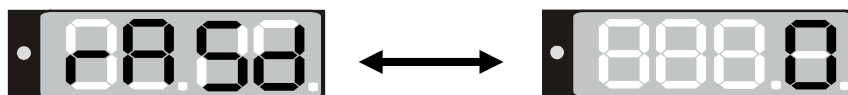

2. Press again button .

The display alternately shows "rASd" and the actual setting of the **set-point gradient**:



3. Set the desired ramp gradient with buttons   (set-point gradient in °F or °C acc. to the selected setting, see chap. 6.4.1).
4. The set value is automatically adopted after 2 seconds.

During ramp operation the actual set-point (SP_r) continually rises in accordance to the entered gradient from the previously entered set-point to the new one (SP). The actual value follows the set-point value.

About set-point display during ramp operation see chap. 6.2.

6.4.3 Chamber addressing

If several incubators BD or drying and heating ovens ED (option) are networked with a PC via the APT-COM™ 4 Multi Management Software (option, chap. 8.2), each chamber must be allocated a unique address. Addressing takes place on the chamber controller as follows:

1. Press down  button for approx. 5 seconds.

The display alternately shows "unit" and the temperature unit:

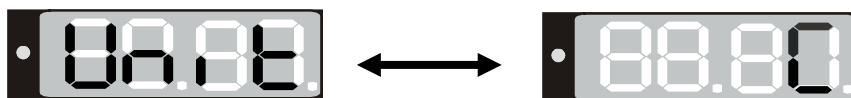

2. Press again button .

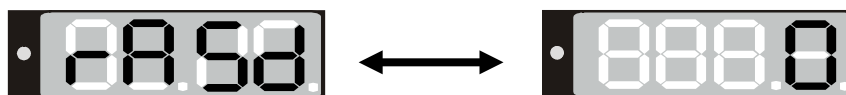

The display alternately shows "rASd" and the set-point gradient:

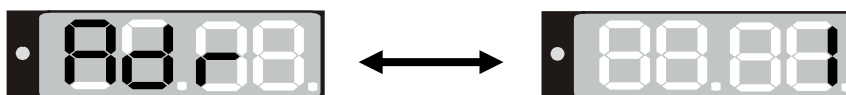

3. Press again button .

The display alternately shows "Adr" and the actual setting of the **chamber address**:



4. Set the required address with buttons  .



You can enter address values between 1 and 30.

5. The set value is automatically adopted after 2 seconds.

6.5 General notes





Approx. 30 sec. after the last entry the controller returns to normal display (actual value display).



The functions set-point entry (chap. 6.1), time functions (chap. 6.3), and calling up the user menu (chap. 6.4) can only be selected from normal display (actual value display).



When selecting the functions set-point entry and time functions, and when selecting the user menu functions, the respective button  or  must be pressed down for a about 1 sec. Shorter pressing will be ignored by the controller.



After a power failure, the timer returns to the previous status. A remaining time, if any, will continue running down.



Adjust the safety device following any changes of the set-point (chap. 7).

7. Temperature safety devices

7.1 Temperature safety device class 2 (DIN 12880) ED, FD

The temperature safety device class 2 protects the chamber, its environment and the charging material from exceeding the maximum permissible temperature.

Please observe the DGUV guidelines 213-850 on safe working in laboratories (formerly BGI/GUV-I 850-0, BGR/GUV-R 120 or ZH 1/119, issued by the employers' liability insurance association) (for Germany).

In the event of a fault in the temperature controller, the safety device (7) **permanently** turns off the chamber. This status is reported visually by the indicator lamp (7a) and, in case of the option audible alarm with activated buzzer (chap. 8.1), by the buzzer sounding.

Check the operation of the safety device (7) by moving it slowly counter-clockwise until the chamber turns off. The safety device cut-off is reported visually by the indicator lamp (7a) and, in case of the option audible alarm with activated buzzer (chap. 8.1), by the buzzer sounding.

Then release again the safety device by pressing the reset button (7b) and turn on the chamber as described.

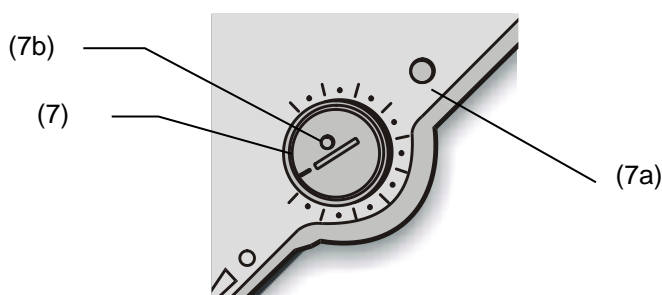

Figure 7: Temperature safety device class 2

Function:

The safety device class 2 is functionally and electrically independent of the temperature control device and turns off the chamber permanently.

If you turn the control knob (7) to its end-stop (position 10), the safety device protects the appliance. If you set it to a temperature a little above the controller's set-point temperature, it protects the charging material.

If the safety device has turned off the chamber, identifiable by the red alarm lamp (7a) lighting up and, in case of the option audible alarm with activated buzzer (chap. 8.1), by the buzzer sounding, proceed as follows:

- Disconnect the chamber from the power supply.
- Have an expert examine and rectify the cause of the fault.
- Release the safety device by pressing the reset button (7b).
- Restart the chamber as described in chap. 5.

Setting:

To check the response temperature of the safety device, turn on the chamber and set the desired set-point at the temperature controller.

The scale division from 1 to 10 corresponds to the temperature range from 30 °C / 86 °F up to 320 °C / 608 °F and serves as a setting aid.

1. Turn the control knob (7) of the safety device using a coin to its end-stop (position 10) (chamber protection).
2. When the set point is reached, turn back the control knob (7) until its trip point (turn it counter-clockwise).
3. The trip point is identifiable by the red alarm lamp (7a) lighting up; the reset button (7b) pops out.

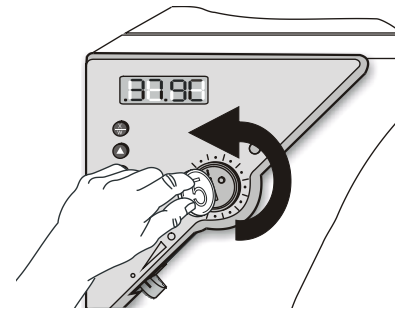

With the option audible alarm and the buzzer activated (chap. 8.1), the buzzer sounds as an additional signal. You can turn it off with switch (10) resp. (9).

4. The optimum setting of the safety device is obtained by turning the control knob clockwise by approx. one graduation mark on the scale.
5. Push the reset button (7b) in again.

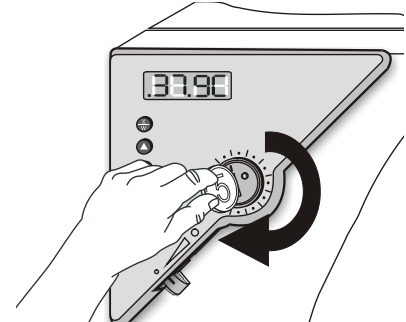

The chamber is only active with the reset button (7b) pushed in.

When the safety device class 2 responds, the red alarm lamp (7a) lights up, the reset button (7b) pops out, and the chamber turns off permanently.



Check the setting regularly and adjust it following any changes of the set-point.

Function check:

Check the temperature safety device class 2 at appropriate intervals for its functionality. It is recommended that the authorized operating personnel should perform such a check, e.g., before starting a longer work procedure.

7.2 Temperature safety device class 3.1 (DIN 12880) BD (option for ED, FD)

The temperature safety device class 3.1 serves to protect the incubator, its environment and the charging material from exceeding the maximum permissible temperature.

Please observe the DGUV guidelines 213-850 on safe working in laboratories (formerly BGI/GUV-I 850-0, BGR/GUV-R 120 or ZH 1/119, issued by the employers' liability insurance association) (for Germany).

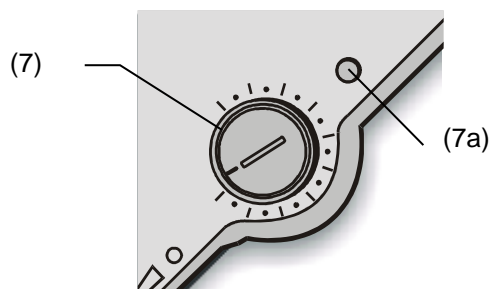

Figure 8: Temperature safety device class 3.1

Function:

The temperature safety device is functionally and electrically independent of the temperature control system and if an error occurs it performs a regulatory function.

If you turn the control knob (7) to its end-stop (position 10), the safety device class 3.1 protects the chamber. If you set it to a temperature a little above the controller's set-point temperature, it protects the charging material.

If the safety device has taken over control (identifiable by the red alarm lamp (7a) lighting up and, in case of the option audible alarm with activated buzzer (chap. 8.1), by the buzzer sounding), proceed as follows:

- Disconnect the chamber from the power supply.
- Have an expert examine and rectify the cause of the fault.
- Restart the chamber (see chapter 5).

Adjustment:

To check the response temperature of the safety thermostat class 3.1, turn on the chamber and set the desired set point on the temperature controller.

The sections of the scale from 1 to 10 correspond to the temperature range from 0 °C / 32 °F to 120 °C / 248 °F (BD) or from 63 °C / 145.4 °F to 350 °C / 662 °F (ED or FD, option) and serve as a setting aid.

1. Turn the control knob (7) of the safety device with a coin to its end-stop (chamber protection).
2. When the set point is reached, turn back the control knob (7) until its trip point (turn it counter-clockwise)
3. The trip point is identifiable by the red alarm lamp (7a) lighting up.

With the option audible alarm and the buzzer activated (chap. 8.1), the buzzer sounds as an additional signal. You can turn it off with switch (10) resp. (9).

4. The optimum setting of the safety device is obtained by turning the control knob clockwise by approx. one scale division, which leads to extinguish the red alarm lamp (7a).

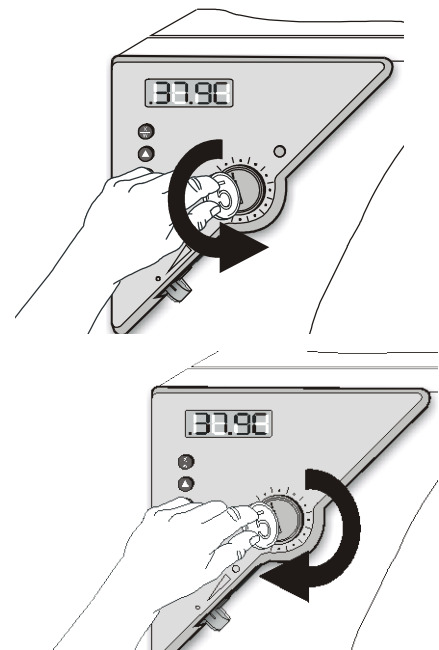

Check the setting regularly and adjust it following any changes of the set-point.

Function check:

Check the temperature safety device class 3.1 at appropriate intervals for its functionality. It is recommended that the authorized operating personnel should perform such a check, e.g., before starting a longer work procedure.

8. Options

8.1 Disconnectable audible over-temperature alarm (option)

This option permits activating an audible signal with the buzzer switch (10) (BD) resp. (9) (ED / FD).

Position 0 = buzzer off

Position 1 = buzzer active

If the buzzer is activated, an audible signal sounds when the limit temperature set at the temperature safety device class 2 (chap. 7.1) or class 3.1 (chap. 7.2) is exceeded, this happens in addition to the red alarm pilot lamp (7a) lighting up. The buzzer can be turned off using the buzzer switch (10) resp. (9).



Turning off the audible alarm does not influence the safety device's regulatory or turning off function. Proceed as described in chap. 7.1 / 7.2.

8.2 APT-COM™ 4 Multi Management Software (option for BD and ED)

The chamber is regularly (BD) or optionally (ED) equipped with a serial interface RS 422 that can connect the BINDER APT-COM™ 4 Multi Management Software. The connection to a computer is established using the chamber's interface via an interface converter RS 422 / RS 232.

The actual temperature values are given at adjustable intervals. Programming can be performed graphically via PC. Up to 100 chambers can be cross linked. For further information, refer to the APT-COM™ 4 operating manual.

Pin allocation of the RS 422 interface:

pin 2:	RxD (+)
pin 3:	TxD (+)
pin 4:	RxD (-)
pin 5:	TxD (-)
pin 7:	Ground



If several incubators BD or drying and heating ovens ED (option) are to be recorded via a PC, each one must be allocated a unique address. Addressing is performed via the chamber controller (see chap. 6.4.3).

8.3 Data logger kit (option)

BINDER Data Logger Kits offer an independent long-term measuring system for temperature. They are equipped with a keyboard and a large LCD display, alarm functions and a real-time function. Measurement data are recorded in the Data Logger and can be read out after the measurement via the RS232 interface of the Data Logger. It offers a programmable measuring interval and permits storing up to 64000 measuring values. Reading out is done with the Data Logger evaluation software. You can give out a combined alarm and status protocol directly to a serial printer.

For BD: Data Logger Kit T 220: Temperature range -90 °C / -130 °F up to +220 °C / 428 °F

For ED/FD: Data Logger Kit T 350: Temperature range 0 °C / 32 °F up to +350 °C / 662 °F



For detailed information on installation and operation of the BINDER Data Logger, please refer to the mounting instructions Art. No. 7001-0204 and to the original user manual of the manufacturer, supplied with the data logger.

8.4 Additional Pt100 temperature sensor (option for BD)

An additional fixed or flexible temperature sensor Pt100 permits measuring the chamber temperature (fixed Pt100) or the temperature of the charging material (flexible Pt100) by means of an independent measuring system with Pt100 entry. The sensor top protective tube of the flexible Pt100 can be immersed into liquid substances.

Technical data of the Pt100 sensor:

- Three-wire technique
- Class B (DIN EN 60751)
- Temperature range up to 320 °C / 608 °F
- Stainless steel protective tube 45 mm length material no. 1.4501

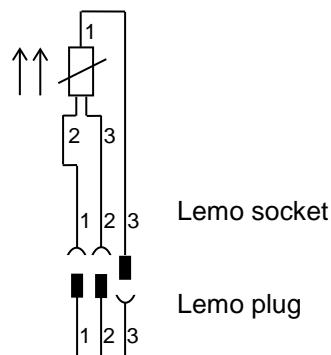
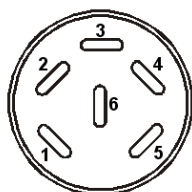

Figure 9: Option temperature sensor Pt100

8.5 Analog output for temperature (option)

With this option the chamber is equipped with an analog output 4-20 mA for temperature. This output permits transmitting data to external data registration systems or devices.

The connection is carried out as a DIN socket at the rear of the chamber as follows:



ANALOG OUTPUT 4-20 mA DC

PIN 1: Temperature –

PIN 2: Temperature +

Temperature range:

BD: 0 °C / 32 °F to +100 °C / 212 °F

ED, FD: 0 °C / 32 °F to +300 °C / 572 °F

A suitable DIN plug is enclosed.

Figure 10: Pin allocation of DIN socket for option analog outputs



8.6 Water protected internal socket (option for BD)

You can turn on or off the disconnectable water protected internal socket by switch (9), independent of the incubator operating or not. Thus, devices operated inside the incubator can be started or stopped without any need to open the chamber doors.

The internal socket is splash proof.

IP system of protection 67 230 V 1N ~ 50-60 Hz. Charge max. 500 W



Maximum permitted operating temperature with this option: 90 °C / 194 °F.

	 WARNING
	<p>Exceeding of the permitted maximum temperature. Electrical hazard. Danger of death. Damage to the internal socket.</p> <ul style="list-style-type: none"> ⊘ Do NOT exceed the temperature set-point of 90 °C / 194 °F. ➤ Set the mechanical thermostat class 3.1 to 90 °C / 194 °F.

	<p>Heat emission of electrical devices connected inside the chamber may modify the temperature range.</p>
---	---



	CAUTION
	<p>Risk of short circuit. Damage to the chamber.</p> <ul style="list-style-type: none"> ➤ Use the delivered plug only (IP protection type 67). Plug-in the plug and turn it to secure. ➤ If the socket is not used, close the lift-up lid and turn it for securing.

Controller shutdown by the On/Off switch (5) has no effect on the internal socket.

	 WARNING
	<p>Internal socket switched on even though controller is shut down. Electrical hazard.</p> <ul style="list-style-type: none"> ➤ Turn off the internal socket separately, when not in use, by switch (9).

9. Maintenance, cleaning, and service

9.1 Maintenance intervals, service

 	 DANGER
	<p>Electrical hazard. Danger of death.</p> <ul style="list-style-type: none"> ∅ The chamber must NOT become wet during operation or maintenance work. ∅ Do NOT remove the rear panel of the chamber. ➤ Disconnect the chamber before conducting maintenance work. Disconnect the power plug. ➤ Ensure all maintenance work is conducted by licensed electricians or experts authorized by BINDER.

Ensure regular maintenance work is performed at least once a year.

	The warranty becomes void if maintenance work is conducted by non-authorized personnel..
---	--

	Replace the door gasket only when cold. Otherwise, the door gasket may become damaged.
---	--



We recommend taking out a maintenance agreement. Please consult BINDER Service.

BINDER telephone hotline:	+49 (0) 7462 2005 555
BINDER fax hotline:	+49 (0) 7462 2005 93555
BINDER e-mail hotline:	service@binder-world.com
BINDER service hotline USA:	+1 866 885 9794 or +1 631 224 4340 x3 (toll-free in the USA)
BINDER service hotline Asia Pacific:	+852 390 705 04 or +852 390 705 03
BINDER service hotline Russia and CIS	+7 495 988 15 16
BINDER Internet website	http://www.binder-world.com
BINDER address	BINDER GmbH, post office box 102, D-78502 Tuttlingen

International customers, please contact your local BINDER distributor.

9.2 Cleaning and decontamination

Clean the chamber after each use to avoid potential corrosion damage by ingredients of the test material.

 	 DANGER
	<p>Electrical hazard. Danger of death.</p> <ul style="list-style-type: none"> ∅ Do NOT spill water or cleaning agents over the inner and outer surfaces. ➤ Disconnect the chamber before cleaning. Disconnect the power plug. ➤ Completely dry the chamber before turning it on again.

9.2.1 Cleaning

Disconnect the chamber from the power supply before cleaning. Disconnect the power plug.

	The interior of the chamber must be kept clean. Thoroughly remove any residues of the charging material
---	---

Wipe the surfaces with a moistened towel. In addition, you can use the following cleaning agents:

Exterior surfaces inner chamber racks door gaskets	Standard commercial cleaning detergents free from acid or halides. Alcohol-based solutions. We recommend using the neutral cleaning agent Art. No. 1002-0016.
Instrument panel	Standard commercial cleaning detergents free from acid or halides. We recommend using the neutral cleaning agent Art. No. 1002-0016.
Zinc coated hinge parts rear chamber wall	Standard commercial cleaning detergents free from acid or halides. Do NOT use a neutral cleaning agent on zinc coated surfaces.

Do not use cleaning agents that may cause a hazard due to reaction with components of the device or the charging material. If there is doubt regarding the suitability of cleaning products, please contact BINDER service.

	<p>We recommend using the neutral cleaning agent Art. No. Art. Nr. 1002-0016 for a thorough cleaning.</p> <p>Any corrosive damage that may arise following use of other cleaning agents is excluded from liability by BINDER GmbH.</p> <p>Any corrosive damage caused by a lack of cleaning, is excluded from liability by BINDER GmbH.</p>
---	---

	<p style="text-align: center;">CAUTION</p> <p>Danger of corrosion. Damage to the chamber.</p> <ul style="list-style-type: none"> Ø Do NOT use acidic or chlorine cleaning detergents. Ø Do NOT use a neutral cleaning agent on other kind of surfaces e.g., the zinc coated hinge parts or the rear chamber wall.
---	--

	<p>For surface protection, perform cleaning as quickly as possible.</p> <p>After cleaning completely remove cleaning agents from the surfaces with a moistened towel. Let the chamber dry.</p>
---	--



	Soapsuds may contain chlorides and must therefore NOT be used for cleaning.
---	---

	With every decontamination method, always use adequate personal safety controls.
---	--

Following cleaning, leave the chamber door open or remove the access port plugs.

	<p>The neutral cleaning agent may cause health problems in contact with skin and if ingested. Follow the operating instructions and safety hints labeled on the bottle of the neutral cleaning agent.</p>
---	---

Recommended precautions: To protect the eyes use sealed protective goggles. Suitable protective gloves with full contact: butyl or nitrile rubber, penetration time >480 minutes.

	<div style="background-color: yellow; text-align: center; padding: 5px;">  CAUTION </div> <p>Contact with skin, ingestion. Skin and eye damage due to chemical burns.</p> <ul style="list-style-type: none"> ∅ Do not ingest. Keep away from food and beverages. ∅ Do NOT empty into drains. ➤ Wear protective gloves and goggles. ➤ Avoid skin contact.
---	---

9.2.2 Decontamination

The operator must ensure that proper decontamination is performed in case a contamination of the chamber by hazardous substances has occurred.

Disconnect the chamber from the power supply prior to decontamination. Pull the power plug.

Do not use decontamination agents that may cause a hazard due to reaction with components of the device or the charging material. If there is doubt regarding the suitability of cleaning products, please contact BINDER service.

You can use the following disinfectants:

Inner chamber	Standard commercial surface disinfectants free from acid or halides. Alcohol-based solutions. We recommend using the disinfectant spray Art. No. 1002-0022.
---------------	---

	For chemical disinfection, we recommend using the disinfectant spray Art. No. 1002-0022. Any corrosive damage that may arise following use of other disinfectants is excluded from liability by BINDER GmbH.
---	--

	With every decontamination method, always use adequate personal safety controls.
---	--

In case of impurity of the interior with biological or chemical hazardous material, there are three possible procedures depending on the type of contamination and of the charging material.

1. The drying and heating ovens ED and FD can be hot air sterilized at 190 °C / 374 °F for at least 30 minutes. All inflammable goods must be removed from the interior before. With the incubators BD it is possible to perform a hot-air disinfection at 100 °C / 212 °F.
2. Spray the inner chamber with an appropriate disinfectant.
 Before start-up, the chamber must be absolute dry and ventilated, because explosive gases may form during the decontamination process.
3. If necessary, have strongly contaminated inner chamber parts removed by an engineer for cleaning, or have them exchanged. Sterilize the inner chamber parts in a sterilizer or autoclave.

	In case of eye contact, the disinfectant spray may cause eye damage due to chemical burns. Follow the operating instructions and safety hints labeled on the bottle of the disinfectant spray.
---	--

10. Disposal

10.1 Disposal of the transport packing

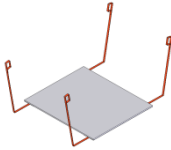
Packing element	Material	Disposal
Straps to fix packing on pallet	Plastic	Plastic recycling
Wooden transport box (option) with metal screws	Non-wood (compressed matchwood, IPPC standard)	Wood recycling
	Metal	Metal recycling
Pallet (from size 115 on) with foamed plastic stuffing (from size 240 on)	Solid wood (IPPC standard)	Wood recycling
Transport box with metal clamps	Cardboard	Paper recycling
	Metal	Metal recycling
Top cover (size 720 only)	Cardboard	Paper recycling
Removal aid (sizes 240 and 400 only) 	Cardboard	Paper recycling
	Plastic	Plastic recycling
Edge protection	Styropor® or PE foam	Plastic recycling
Protection of doors and racks	PE foam	Plastic recycling
Bag for operating manual	PE foil	Plastic recycling
Insulating air cushion foil (packing of optional accessories)	PE foil	Plastic recycling

If recycling is not possible, all packing parts can also be disposed of with normal waste.

10.2 Decommissioning

Turn off ED chambers sizes 400 and 720 at the main power switch (10). Disconnect the chamber from the power supply.

	When turning off the main power switch (10), the stored parameters remain saved.
---	--

- Temporal decommissioning: See indications for appropriate storage, chap. 3.3.
- Final decommissioning: Dispose of the chamber as described in chap. 10.3 to 10.5.

10.3 Disposal of the chamber in the Federal Republic of Germany

According to Annex I of Directive 2012/19/EU of the European Parliament and of the Council on waste electrical and electronic equipment (WEEE), BINDER devices are classified as “monitoring and control instruments” (category 9) only intended for professional use“. They must not be disposed of at public collecting points.

The chambers bear the symbol for the marking of electrical and electronic equipment manufactured / placed on the market in the EC after 13 August 2005 and be disposed of in separate collection according to Directive 2012/19/EU on waste electrical and electronic equipment (WEEE) and German national law for electrical and electronic equipment (Elektro- und Elektronikgerätegesetz, ElektroG). WEEE marking: crossed-out wheeled bin with solid bar under. A significant part of the materials must be recycled in order to protect the environment.

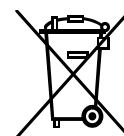



At the end of the device's service life, have the device disposed of according to the German national law for electrical and electronic equipment (Elektro- und Elektronikgerätegesetz, ElektroG from 20 October 2015, BGBl. I p. 1739) or contact BINDER service who will organize taking back and disposal of the chamber according to the German national law for electrical and electronic equipment (Elektro- und Elektronikgerätegesetz, ElektroG from 20 October 2015, BGBl. I p. 1739).

	CAUTION
	<p>Violation against existing law.</p> <ul style="list-style-type: none"> ⊘ Do NOT dispose of BINDER devices at public collecting points. ➤ Have the device disposed of professionally at a recycling company which is certified according to the German national law for electrical and electronic equipment (Elektro- und Elektronikgerätegesetz, ElektroG from 20 October 2015, BGBl. I p. 1739). <li style="text-align: center;"><i>or</i> ➤ Instruct BINDER Service to dispose of the device. The general terms of payment and delivery of BINDER GmbH apply, which were valid at the time of purchasing the chamber.

Certified companies disassemble waste BINDER equipment in primary substances for recycling according to Directive 2012/19/EU. In order to eliminate any health hazards to the employees of the recycling companies, the devices must be free from toxic, infectious or radioactive substances.

	<p>Prior to handing the chamber over to a recycling company, it is the user's responsibility that it is free from toxic, infectious or radioactive substances.</p> <ul style="list-style-type: none"> • Prior to disposal, clean all introduced or residual toxic substances from the chamber. • Prior to disposal, disinfect the chamber from all sources of infection. Be aware of the fact that sources of infection may also be located outside the inner chamber. • If you cannot safely remove all toxic substances and sources of infection from the chamber, dispose of it as "special" waste according to national law. • Fill out the contamination clearance certificate (chap. 15) and enclose it with the chamber.
---	---

 	WARNING
	<p>Contamination of the device with toxic, infectious or radioactive substances.</p> <p>Danger of intoxication.</p> <p>Danger of infection.</p> <ul style="list-style-type: none"> ⊘ NEVER take a chamber contaminated with toxic substances or sources of infection for recycling according to Directive 2012/19/EU. ➤ Prior to disposal, remove all toxic substances and sources of infection from the chamber. ➤ Dispose of a chamber from which all toxic substances or sources of infection cannot be safely removed as special waste according to national law.

10.4 Disposal of the chamber in the member states of the EU except for the Federal Republic of Germany

According to Annex I of Directive 2012/19/EU of the European Parliament and of the Council on waste electrical and electronic equipment (WEEE), BINDER devices are classified as "monitoring and control instruments" (category 9) only intended for professional use". They must not be disposed of at public collecting points.

The chambers bear the symbol for the marking of electrical and electronic equipment manufactured / placed on the market in the EC after 13 August 2005 and be disposed of in separate collection according to the Directive 2012/19/EU on waste electrical and electronic equipment (WEEE). WEEE marking: crossed-out wheeled bin with solid bar under.

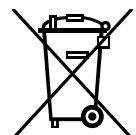



At the end of the device's service life, notify the distributor who sold you the device, who will take back and dispose of the chamber according to the Directive 2012/19/EU on waste electrical and electronic equipment (WEEE).



	CAUTION
	<p>Violation against existing law.</p> <ul style="list-style-type: none"> ⊘ Do NOT dispose of BINDER devices at public collecting points. ➤ Have the device disposed of professionally at a recycling company which is certified according to conversion of the Directive 2012/19/EU into national law. <li style="padding-left: 20px;"><i>or</i> ➤ Instruct the distributor who sold you the device to dispose of it. The agreements apply that were reached with the distributor when purchasing the chamber (e.g. his general terms of payment and delivery). ➤ If your distributor is not able to take back and dispose of the chamber, please contact BINDER service.

Certified companies disassemble waste BINDER equipment in primary substances for recycling according to Directive 2012/19/EU. In order to exclude any health hazard for the employees of the recycling companies, the devices must be free from toxic, infectious or radioactive substances.

	<p>Prior to handing the chamber over to a recycling company, it is the user's responsibility that it is free from toxic, infectious or radioactive substances.</p> <ul style="list-style-type: none"> • Prior to disposal, clean all introduced or residual toxic substances from the chamber. • Prior to disposal, disinfect the chamber from all sources of infection. Be aware of the fact that sources of infection may also be located outside the inner chamber. • If you cannot safely remove all sources of infection and toxic substances from the chamber, dispose of it as "special" waste according to national law. • Fill out the contamination clearance certificate (chap. 15) and enclose it with the chamber.
---	---

 	WARNING
	<p>Contamination of the device with toxic, infectious or radioactive substances. Danger of intoxication. Danger of infection.</p> <ul style="list-style-type: none"> ⊘ NEVER take a chamber contaminated with toxic substances or sources of infection for recycling according to Directive 2012/19/EU. ➤ Prior to disposal, remove all toxic substances and sources of infection from the chamber. ➤ Dispose of a chamber from which all toxic substances or sources of infection cannot be safely removed as "special" waste according to national law.

10.5 Disposal of the chamber in non-member states of the EU

 	CAUTION
	<p>Alteration of the environment.</p> <ul style="list-style-type: none"> ➤ For final decommissioning and disposal of the chamber, please contact BINDER Service. ➤ Follow the statutory regulations for appropriate, environmentally friendly disposal.

11. Troubleshooting

Fault description	Possible cause	Required measures
Temperature		
Set-point temperature is not reached after specified time.	Chamber door not properly closed.	Completely close chamber door.
	Door gasket defective.	Replace door gasket,
	Controller not adjusted.	Calibrate and adjust controller.
	Wrong voltage.	Check power supply for voltage of 115V or 230V.
<i>FD</i> : The fan doesn't turn or turns too slowly.	Fan defective.	Contact BINDER service.
Chamber heating permanently, set-point not held.	Controller defective.	Contact BINDER service.
	Pt 100 sensor defective.	
	Semiconductor relay defective	
	Controller not adjusted.	Calibrate and adjust controller.
Chamber doesn't heat up. Red heating control light in the display is lit.	Heating element defective.	Contact BINDER service.
	Semiconductor relay defective.	
Chamber doesn't heat up. Red heating control light in the display is not lit. Controller display working.	Timer run off.	Program the timer or change to time function Continuous operation (chap. 6.3)
	Semiconductor relay defective.	Contact BINDER service.
	Controller defective.	
Chamber without function, only the green "stand-by" LED is lit	Chamber in stand-by mode	Press down the ON/OFF button (5) until the display lights up.
<i>BD, option ED, FD</i> : Temperature inside the chamber too high, Red alarm pilot lamp of safety device (7a) is lit..	Safety device class 3.1 has responded.	Check the settings of the temperature set-point and of the safety device class 3.1 (chap. 7.2).
<i>ED, FD</i> : Chamber without function. Red alarm pilot lamp of safety device (7a) is lit.	Safety device class 2 has turned off the chamber.	Let cool down the chamber and press down RESET button. Check the settings of the temperature set-point and of the safety device class 2 (chap. 7.1). If appropriate, select suitable limit value.
	Safety device class 2 defective.	Contact BINDER service.
Chamber without any function.	No power supply.	Check connection to power supply.
	Chamber fuse has responded.	Check chamber fuse and replace it if appropriate. If it responds again, contact BINDER service.
	Controller defective.	Contact BINDER service.
Deviations from the indicated heating-up times.	Chamber fully loaded.	Load the chamber less or consider longer heating-up times.
Controller		
Message „1999" in the controller display	Sensor rupture between sensor and controller.	Contact BINDER service.
The controller returns to Normal Display from any level.	No button was hit for more than approx. 30 sec.	Repeat entries, enter the values rapidly.



Only qualified service personnel authorized by BINDER must perform repair. Repaired chambers must comply with the BINDER quality standards.

12. Technical description

12.1 Factory calibration and adjustment

This chamber was calibrated and adjusted in the factory. Calibration and adjustment were performed using standardized test instructions, according to the QM DIN EN ISO 9001 system applied by BINDER (certified since December 1996 by TÜV CERT). All test equipment used is subject to the administration of measurement and test equipment that is also constituent part of the BINDER QM DIN EN ISO 9001 systems. They are controlled and calibrated to a DKD-Standard at regular intervals.

12.2 Definition of usable volume

The usable volume illustrated below is calculated as follows:

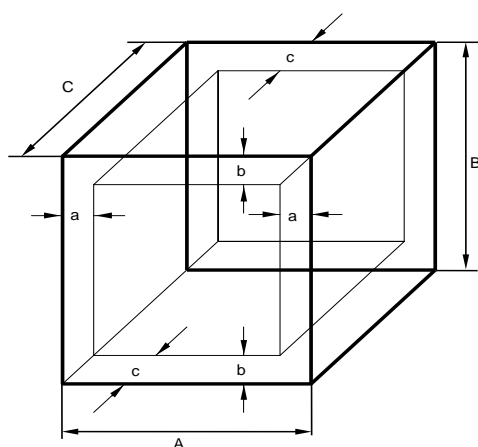

A, B, C = Internal dimensions (W, H, D)
a, b, c = Wall clearances

$$a = 0.1 \times A$$

$$b = 0.1 \times B$$

$$c = 0.1 \times C$$

$$V_{\text{USE}} = (A - 2a) \times (B - 2b) \times (C - 2c)$$

Figure 11: Determination of the useable volume

The technical data refers to the defined usable volume.



Do NOT place samples outside this usable volume.
Do NOT load this volume by more than half to enable sufficient airflow inside the chamber.
Do NOT divide the usable volume into separate parts with large area samples.
Do NOT place samples too close to each other in order to permit circulation between them and thus obtain a homogenous distribution of temperature.

12.3 Over current protection

Single-phase devices are protected by a miniature fuse against over current, accessible from the outside. The miniature fuse is located at the rear of the chamber below the strain relief of the power cord. The fuse holder is equipped with a fuse clip 5mm x 20 mm. (CUL-Version 6,3x32 mm). The fuse may be replaced only with a substitute of the same ratings. Refer to the technical data of the respective device type.

Three-phase devices are equipped with internal fuses not accessible from outside. If these fuses are blown, please inform an electronic engineer or BINDER service.

12.4 BD technical data

Chamber size		BD 23	BD 53	BD 115	BD 240	BD 400	BD 720
Exterior dimensions							
Width, net	mm inch	435 17.13	635 25.00	835 32.87	1035 40.75	1235 48.62	1235 48.62
Height, gross (incl. feet/castors)	mm inch	495 19.49	620 24.41	705 27.76	825 32.48	1025 40.35	1530 60.24
Depth	mm inch	520 20.47	575 22.64	645 25.39	745 29.33	765 30.12	865 34.06
Depth, gross (incl. door handle and exhaust duct)	mm inch	625 24.61	680 26.77	750 29.53	850 33.46	870 34.25	970 38.19
Wall clearance rear (minimum)	mm inch	100 3.94	100 3.94	100 3.94	100 3.94	100 3.94	100 3.94
Wall clearance side (minimum)	mm inch	100 3.94	160 6.30	160 6.30	160 6.30	160 6.30	160 6.30
Exhaust duct, outer diameter	mm inch	52 2.05	52 2.05	52 2.05	52 2.05	52 2.05	52 2.05
Doors							
Number of doors		1	1	1	2	2	2
Interior dimensions							
Width	mm inch	222 8.74	400 15.75	600 23.62	800 31.50	1000 39.37	1000 39.37
Height	mm inch	330 12.99	400 15.75	480 18.90	600 23.62	800 31.50	1200 47.24
Depth	mm inch	277 10.91	330 12.99	400 15.75	500 19.69	500 19.69	600 23.62
Interior volume	l cu.ft.	20 0.7	53 1.9	115 4.1	240 8.6	400 14.3	720 25.7
Steam space volume	l cu.ft.	36 1.27	70 2.47	142 5.02	283 10.0	457 16.15	808 28.55
Racks							
Quantity of racks (regular)		2	2	2	2	2	2
Quantity of racks (max.)		4	4	5	7	9	15
Load per rack	Kg lbs	12 26	15 33	20 44	30 66	35 77	45 99
Permitted total load	Kg lbs	25 55	40 88	50 110	70 155	90 199	120 265
Weight							
Weight (empty)	Kg lbs	27 60	43 95	61 135	93 205	135 298	191 422
Temperature data							
Temperature range, 5 °C / 9 °F above ambient up to	°C °F	100 212	100 212	100 212	100 212	100 212	100 212
Temperature fluctuation	at 37 °C	± K	0.2	0.1	0.1	0.1	0.1
	at 50 °C	± K	0.4	0.1	0.1	0.1	0.2
Temperature uniformity (variation)	at 37 °C	± K	0.5	0.5	0.4	0.5	0.5
	at 50 °C	± K	1.8	1.1	0.8	0.9	1.0
Heating up time	to 37 °C	minutes	59	92	70	98	120
	to 50 °C	minutes	115	108	90	115	120
Recovery time after door was opened for 30 sec	at 37 °C	minutes	20	15	10	7	10
	at 50 °C	minutes	30	20	12	20	30

Chamber size		BD 23	BD 53	BD 115	BD 240	BD 400	BD 720
Electrical data (model versions BD023-230V, BD053-230V, BD115-230V, BD240-230V, BD400-230V, BD720-230V)							
IP system of protection acc. to EN 60529		IP	20	20	20	20	20
Nominal voltage (±10 %)	at 50 Hz power frequency	V	230	230	230	230	230
	at 60 Hz power frequency	V	230	230	230	230	230
Current type			1N~	1N~	1N~	1N~	1N~
Nominal power		kW	0.2	0.4	0.4	0.68	1.25
Chamber fuse 5 x 20 mm 230V / 10A / middle-time-lag (M)		Amp	10 external	10 external	10 external	10 external	10 external
Power plug			Grounded plug				
Installation category acc. to IEC 61010-1			II	II	II	II	II
Pollution degree acc. to IEC 61010-1			2	2	2	2	2
Different electrical data for BD-UL constructed for the USA and Canada (model versions BD023UL-120V, BD053UL-120V, BD115UL-120V, BD240UL-120V, BD400UL-120V, BD720UL-120V)							
Nominal voltage (±10 %) at 60 Hz power frequency		V	115	115	115	115	115
Current type			1N~	1N~	1N~	1N~	1N~
Nominal current		Amp	1.8	2.6	3.5	5.9	10.9
Power plug		NEMA	5-15P	5-15P	5-15P	5-15P	5-20P
Chamber fuse 6,3 x 32 mm 250V / super-time-lag TT		Amp	12,5 external	12,5 external	12,5 external	12,5 external	16 external
Additional temperature fuse class 1 (DIN 12880:2007)			internal	internal	internal	internal	internal
Environment-specific data							
Noise level (mean value)		dB (A)	< 45	< 45	< 45	< 45	< 45
Energy consumption at 37°C / 98.6°F		Wh/h	11	11	20	33	80

All technical data is specified for unloaded chambers with standard equipment at an ambient temperature of +22 °C +/- 3 °C / 71.6 °F +/- 5.4 °F and a power supply voltage fluctuation of +/-10. Technical data is determined in accordance to BINDER Factory Standard Part 1:2015 following DIN 12880:2007.

All indications are average values, typical for units produced in series. We reserve the right to change technical specifications at any time.

	If the chamber is fully loaded, the specified heating up times may vary according to the load.
---	--

	With option interior socket: If electrical devices are connected and operating inside the chamber, the temperature range may be modified due to heat emission.
---	--

12.5 ED technical data

Chamber size		ED 23	ED 53	ED 115	ED 240	ED 400	ED 720
Exterior dimensions							
Width, net	mm	435	635	835	1035	1235	1235
	inch	17.13	25.00	32.87	40.75	48.62	48.62
Height, gross (incl. feet/castors)	mm	495	620	705	825	1025	1530
	inch	19.49	24.41	27.76	32.48	40.35	60.24
Depth	mm	520	575	645	745	765	865
	inch	20.47	22.64	25.39	29.33	30.12	34.06
Depth, gross (incl. door handle and exhaust duct)	mm	625	680	750	850	870	970
	inch	24.61	26.77	29.53	33.46	34.25	38.19
Wall clearance rear	mm	100	100	100	100	100	100
	inch	3.94	3.94	3.94	3.94	3.94	3.94

Chamber size		ED 23	ED 53	ED 115	ED 240	ED 400	ED 720
Exterior dimensions (continued)							
Wall clearance side	mm	100	160	160	160	160	160
	inch	3.94	6.30	6.30	6.30	6.30	6.30
Exhaust duct, outer diameter	mm	52	52	52	52	52	52
	inch	2.05	2.05	2.05	2.05	2.05	2.05
Doors							
Number of doors		1	1	1	2	2	2
Interior dimensions							
Width	mm	222	400	600	800	1000	1000
	inch	8.74	15.75	23.62	31.50	39.37	39.37
Height	mm	330	400	480	600	800	1200
	inch	12.99	15.75	18.90	23.62	31.50	47.24
Depth	mm	277	330	400	500	500	600
	inch	10.91	12.99	15.75	19.69	19.69	23.62
Interior volume	l	20	53	115	240	400	720
	cu.ft.	0.7	1.9	4.1	8.6	14.3	25.7
Steam space volume	l	36	70	142	283	457	808
	cu.ft.	1.27	2.47	5.02	10.0	16.15	28.55
Racks							
Quantity of racks (regular)		2	2	2	2	2	2
Quantity of racks (max.)		4	5	6	7	10	16
Load per rack	Kg	12	15	20	30	35	45
	lbs	26	33	44	66	77	99
Permitted total load	Kg	25	40	50	70	90	120
	lbs	55	88	110	155	199	265
Weight							
Weight (empty)	Kg	26	42	57	86	125	174
	lbs	57	93	126	190	276	384
Temperature data							
Temperature range, 5 °C / 9 °F above ambient up to		°C	300	300	300	300	300
		°F	572	572	572	572	572
Temperature fluctuation	at 70 °C / 158 °F	±K	0,2	--	--	--	0,2
	at 150 °C / 302 °F	±K	0,5	0,3	0,6	0,3	0,5
	at 300 °C / 572 °F	±K	--	--	--	--	0,8
Temperature uniformity (variation)	at 70 °C / 158 °F	±K	1.5	2	1.5	1.5	1.7
	at 150 °C / 302 °F	±K	2.8	4.5	2.5	2.7	3.0
	at 300 °C / 572 °F	±K	4.0	4.5	6.3	6.6	10.0
Heating up time	to 70 °C / 158 °F	minutes	22	46	15	69	80
	to 150 °C / 302 °F	minutes	28	41	46	71	71
	to 250 °C / 482 °F	minutes	40	--	--	--	--
	to 300 °C / 572 °F	minutes	--	58	77	71	130
Recovery time after door was open for 30 sec	at 70 °C / 158 °F	minutes	20	15	8	15	12
	at 150 °C / 302 °F	minutes	28	25	20	30	31
	at 300 °C / 572 °F	minutes	15	15	18	22	32
Ventilation data							
Air change	at 70 °C / 158 °F	x/h	10	8	12	11	10
	at 150 °C / 302 °F	x/h	13	12	10	10	9
	at 300 °C / 572 °F	x/h	17	20	10	9	8

Chamber size			ED 23	ED 53	ED 115	ED 240	ED 400	ED 720	
Electrical data (model versions ED023-230V, ED053-230V, ED115-230V, ED240-230V, ED400-230V, ED720-230V)									
IP system of protection acc. to EN 60529			20	20	20	20	20	20	
Nominal voltage (±10 %)	at 50 Hz power frequency	V	230	230	230	230	400	400	
	at 60 Hz power frequency	V	230	230	230	230	400	400	
Current type			1N~	1N~	1N~	1N~	3N~	3N~	
Nominal power			kW	0.8	1.20	1.60	2.70	3.40	5.00
Chamber fuse 5 x 20 mm / 230V / middle-time-lag (M)			Amp	10 external	10 external	10 external	16 external	3 x 16 internal	3 x 16 internal
Power plug			Grounded plug				CEE plug 5 poles		
Installation category acc. to IEC 61010-1			II	II	II	II	II	II	
Pollution degree acc. to IEC 61010-1			2	2	2	2	2	2	
Different electrical data for ED-UL constructed for the USA and Canada (model versions ED023UL-120V, ED053UL-120V, ED115UL-120V, ED240UL-208V, ED400UL-208V, ED720UL-208V)									
Nominal voltage (±10 %) at 60 Hz power frequency			V	115	115	115	208	208	208
Current type				1N~	1N~	1N~	3N~	3N~	3N~
Nominal current			Amp	7.0	10.5	14.0	11.2	10.6	15.6
Power plug			NEMA	5-20P	5-20P	5-20P	L21-20P	L21-20P	L21-20P
Chamber fuse 6,3 x 32 mm / 250V / super-time-lag TT			Amp	12.5 external	16 external	16 external	3 x 16 internal	3 x 16 internal	3 x 16 internal
Environment-specific data									
Noise level (mean value)			dB (A)	< 45	< 45	< 45	< 45	< 45	< 45
Energy consumption	at 70 °C / 158 °F		Wh/h	43	60	90	143	201	220
	at 150 °C / 302 °F		Wh/h	148	210	300	447	672	750
	at 300 °C / 572 °F		Wh/h	450	600	360	700	1000	1200

All technical data is specified for unloaded chambers with standard equipment at an ambient temperature of +22 °C +/- 3 °C / 71.6 °F +/- 5.4 °F and a power supply voltage fluctuation of +/-10. Technical data is determined in accordance to BINDER Factory Standard Part 1:2015 following DIN 12880:2007.

All indications are average values, typical for units produced in series. We reserve the right to change technical specifications at any time.

	If the chamber is fully loaded, the specified heating up times may vary according to the load.
---	--

12.6 FD technical data

Chamber size		FD 23	FD 53	FD 115	FD 240
Exterior dimensions					
Width, net	mm / inch	435 / 17.13	635 / 25.00	835 / 32.87	1035 / 40.75
Height, gross (incl. feet/castors)	mm / inch	495 / 19.49	620 / 24.41	705 / 27.76	825 / 32.48
Depth	mm / inch	520 / 20.47	575 / 22.64	645 / 25.39	745 / 29.33
Depth, gross (incl. door handle and exhaust duct)	mm / inch	625 24.61	680 26.77	750 29.53	850 33.46
Wall clearance rear (minimum)	mm / inch	100 / 3.94	100 / 3.94	100 / 3.94	100 / 3.94
Wall clearance side (minimum)	mm / inch	100 / 3.94	160 / 6.30	160 / 6.30	160 / 6.30
Exhaust duct, outer diameter	mm / inch	52 / 2.05	52 / 2.05	52 / 2.05	52 / 2.05
Doors					
Number of doors		1	1	1	2

Chamber size		FD 23	FD 53	FD 115	FD 240	
Interior dimensions						
Width	mm / inch	222 / 8.74	400 / 15.75	600 / 23.62	800 / 31.50	
Height	mm / inch	330 / 12.99	400 / 15.75	480 / 18.90	600 / 23.62	
Depth	mm / inch	277 / 10.91	330 / 12.99	400 / 15.75	500 / 19.69	
Interior volume	l / cu.ft.	20 / 0.7	53 / 1.9	115 / 4.1	240 / 8.6	
Steam space volume	l / cu.ft.	36 / 1.27	77 / 2.72	158 / 5.58	308 / 10.88	
Racks						
Quantity of racks (regular)		2	2	2	2	
Quantity of racks (max.)		4	5	6	7	
Load per rack	Kg / lbs	12 / 26	15 / 33	20 / 44	30 / 66	
Permitted total load	Kg / lbs	25 / 55	40 / 88	50 / 110	70 / 155	
Weight						
Weight (empty)	Kg / lbs	28 / 62	44 / 97	62 / 137	96 / 212	
Temperature data						
Temperature range, 5 °C above ambient up to		°C / °F	300 / 572	300 / 572	300 / 572	300 / 572
Temperature fluctuation	at 70 °C / 158 °F	± K	--	0,1	0,1	0,1
	at 150 °C / 302 °F	± K	0,3	0,3	0,3	0,3
	at 300 °C / 572 °F	± K	--	0,2	0,3	0,4
Temperature uniformity (variation)	at 70 °C / 158 °F	± K	0.8	0.8	0.7	0.8
	at 150 °C / 302 °F	± K	2.5	3.0	2.6	2.9
	at 300 °C / 572 °F	± K	4.5	6.7	4.6	6.3
Heating up time	to 70 °C / 158 °F	minutes	10	7	20	22
	to 150 °C / 302 °F	minutes	25	24	28	27
	to 300 °C / 572 °F	minutes	59	60	75	66
Recovery time after door was open for 30 sec	at 70 °C / 158 °F	minutes	5	4	3	2
	at 150 °C / 302 °F	minutes	6	5	5	6
	at 300 °C / 572 °F	minutes	10	9	13	13
Ventilation data						
Air change	at 70 °C / 158 °F	x/h	59	59	29	19
	at 150 °C / 302 °F	x/h	64	64	32	20
	at 300 °C / 572 °F	x/h	53	53	26	18
Electrical data (model versions FD023-230V, FD053-230V, FD115-230V, FD240-230V)						
IP system of protection acc. to EN 60529		IP	20	20	20	20
Nominal voltage (±10%)	at 50 Hz power frequency	V	230	230	230	230
	at 60 Hz power frequency	V	230	230	230	230
Current type			1N~	1N~	1N~	1N~
Nominal power		kW	0.8	1.20	1.60	2.70
Power plug			Grounded plug			
Chamber fuse 5x20mm / 230V / time-lag M		Amp	10 external	10 external	10 external	16 external
Installation category acc. to IEC 61010-1			II	II	II	II
Pollution degree acc. to IEC 61010-1			2	2	2	2

Chamber size		FD 23	FD 53	FD 115	FD 240	
Different electrical data for FD-UL constructed for the USA and Canada (model versions FD023UL-120V, FD053UL-120V, FD115UL-120V, FD240UL-208V)						
Nominal voltage ($\pm 10\%$) at 60 Hz power frequency	V	115	115	115	208	
Current type		1N~	1N~	1N~	3N~	
Nominal current	Amp	7.0	10.5	14.0	11.2	
Power plug	NEMA	5-15P	5-20P	5-20P	L21-20P	
Chamber fuse 6,3 x 32 mm / 250V / super time-lag TT	Amp	12,5 external	16 external	16 external	3 x 16 internal	
Environment-specific data						
Noise level (mean value)	dB (A)	< 55	< 55	< 55	< 55	
Energy consumption	at 70 °C / 158 °F	Wh/h	145	172	230	370
	at 150 °C / 302 °F	Wh/h	300	429	544	850
	at 300 °C / 572 °F	Wh/h	720	951	1100	1400

All technical data is specified for unloaded chambers with standard equipment at an ambient temperature of $+22\text{ °C} \pm 3\text{ °C}$ / $71.6\text{ °F} \pm 5.4\text{ °F}$ and a power supply voltage fluctuation of ± 10 . Technical data is determined in accordance to BINDER Factory Standard Part 1:2015 following DIN 12880:2007.

All indications are average values, typical for units produced in series. We reserve the right to change technical specifications at any time.



If the chamber is fully loaded, the specified heating up times may vary according to the load.

12.7 Equipment and options BD (extract)



To operate the chamber, use only original BINDER accessories or accessories / components from third-party suppliers authorized by BINDER. The user is responsible for any risk arising from using unauthorized accessories.

Chamber size	BD 23	BD 53	BD 115	BD 240	BD 400	BD 720
Standard equipment						
Microprocessor temperature controller with LED display, timer function, and ramp function	●	●	●	●	●	●
Temperature safety device class 3.1 acc. to DIN 12880:2007	●	●	●	●	●	●
Inner glass door	●	●	●	●	●	●
Communication interface RS 422	●	●	●	●	●	●
Exhaust duct, internal diameter 50 mm / 1.97 inches, with adjustable ventilation slide	●	●	●	●	●	●
Four castors (2 lockable)	--	--	--	--	--	●

Options / accessories						
Rack, chrome-plated or stainless steel	○	○	○	○	○	○
Perforated rack, stainless steel	○	○	○	○	○	○
Access ports with various diameters, with silicone plug	○	○	○	○	○	○
Lockable door	○	○	○	○	○	○
Rubber pads for safe stacking (4 pieces)	○	○	○	--	--	--
Additional Pt 100 temperature sensor, fix or flexible, with external connection including LEMO plug (3 pins)	○	○	○	○	○	○
Water-proof interior socket, IP type of protection 65, 230 V 1N ~ 50-60 Hz. Max. load 500 W	○	○	○	○	○	○
Analog output 4-20 mA for temperature with 6 pole DIN socket, DIN plug included	○	○	○	○	○	○
Disconnectable audible over-temperature alarm	○	○	○	○	○	○
Data logger kit T 220	○	○	○	○	○	○
Factory calibration certificate	○	○	○	○	○	○
Extension to factory calibration certificate (additional values)	○	○	○	○	○	○
Measuring protocol acc. to DIN 12880:2007	○	○	○	○	○	○
Qualification folder	○	○	○	○	○	○
Chamber acc. to cUL standard in 115V 1N~60Hz	○	○	○	○	○	○
Neutral cleaning agent (liquid concentrate)	○	○	○	○	○	○
Stable table on wheels with castors and locking brakes	--	○	○	○	○	--

Legend: ● Standard equipment ○ Optional -- Not available

12.8 Equipment and options ED (extract)



To operate the chamber, use only original BINDER accessories or accessories / components from third-party suppliers authorized by BINDER. The user is responsible for any risk arising from using unauthorized accessories.

Chamber size	ED 23	ED 53	ED 115	ED 240	ED 400	ED 720
Standard equipment						
Microprocessor temperature controller with LED display, timer function, and ramp function	●	●	●	●	●	●
Temperature safety device class 2 acc. to DIN 12880:2007	●	●	●	●	●	●
Exhaust duct, internal diameter 50 mm / 1.97 inches, with adjustable ventilation slide	●	●	●	●	●	●
Four castors (2 lockable)	--	--	--	--	--	●

Options / accessories						
Rack, chrome-plated or stainless steel	○	○	○	○	○	○
Perforated rack, stainless steel	○	○	○	○	○	○
Access ports with various diameters, with silicone plug	○	○	○	○	○	○
Communication interface RS 422	○	○	○	○	○	○
Lockable door	○	○	○	○	○	○
Door with window and interior lightning	○	○	○	○	--	--
FKM door gasket (temperature resistant up to 200 °C)	○	○	○	○	○	○
Rubber pads for safe stacking (4 pieces)	○	○	○	○	--	--
Temperature safety device class 3.1 acc. to DIN 12880:2007	○	○	○	○	○	○
Analog output 4-20 mA for temperature with 6 pole DIN socket, DIN plug included	○	○	○	○	○	○
Disconnectable audible over-temperature alarm	○	○	○	○	○	○
Data logger kit T 350	○	○	○	○	○	○
Factory calibration certificate	○	○	○	○	○	○
Extension to factory calibration certificate (additional values)	○	○	○	○	○	○
Qualification folder	○	○	○	○	○	○
Chamber acc. to cUL standard in 115 V 1N~60Hz	○	○	○	--	--	--
Chamber acc. to cUL standard in 208 V 3N~60Hz	--	--	--	○	○	○
Neutral cleaning agent (liquid concentrate)	○	○	○	○	○	○
Stable table on wheels with castors and locking brakes	--	○	○	○	○	--

Legend: ● Standard equipment ○ Optional -- Not available

12.9 Equipment and options FD (extract)



To operate the chamber, use only original BINDER accessories or accessories / components from third-party suppliers authorized by BINDER. The user is responsible for any risk arising from using unauthorized accessories.

Chamber size	FD 23	FD 53	FD 115	FD 240
Standard equipment				
Microprocessor temperature controller with LED display, timer function, and ramp function	●	●	●	●
Temperature safety device cl. 2 acc. to DIN 12880:2007	●	●	●	●
Exhaust duct, internal diameter 50 mm / 1.97 inches, with adjustable ventilation slide	●	●	●	●

Options / accessories				
Rack, chrome-plated or stainless steel	○	○	○	○
Perforated rack, stainless steel	○	○	○	○
Reinforced rack stainless steel, with 1 set rack lockings	--	--	--	○
Access ports with various diameters, with silicone plug	○	○	○	○
Lockable door	○	○	○	○
Door with window and interior lightning	○	○	○	○
FKM door gasket (temperature resistant up to 200 °C)	○	○	○	○
Rubber pads for safe stacking (4 pieces)	○	○	○	--
Temperature safety device class 3.1 acc. to DIN 12880:2007	○	○	○	○
Analog output 4-20 mA for temperature with 6 pole DIN socket, DIN plug included	○	○	○	○
Disconnectable audible over-temperature alarm	○	○	○	○
Data logger kit T 350	○	○	○	○
Factory calibration certificate	○	○	○	○
Extension to factory calibration certificate (additional values)	○	○	○	○
Qualification folder	○	○	○	○
Chamber acc. to cUL standard in 115 V 1N~60Hz	○	○	○	--
Chamber acc. to cUL standard in 208 V 3N~60Hz	--	--	--	○
Neutral cleaning agent (liquid concentrate)	○	○	○	○
Stable table on wheels with castors and locking brakes	--	○	○	○

Legend: ● Standard equipment ○ Optional -- Not available

12.10 Accessories and spare parts (extract)



BINDER GmbH is responsible for the safety features of the chamber only, provided skilled electricians or qualified personnel authorized by BINDER perform all maintenance and repair, and if components relating to chamber safety are replaced in the event of failure with original spare parts. The user is responsible for any risks arising from using unauthorized accessories/components.

Chamber size	23	53	115	240	400	720
Description	Art. No.					
Rack, chrome-plated	6004-0050	6004-0002	6004-0003	6004-0004	6004-0005	6004-0006
Rack, stainless steel	6004-0051	6004-0007	6004-0008	6004-0009	6004-0011	6004-0010
Perforated rack, stainless steel	6004-0052	6004-0029	6004-0030	6004-0031	6004-0032	6004-0033
Reinforced rack with rack lockings <i>FD</i>	--	--	--	8012-0345	--	--
Door gasket, silicone	6005-0090	6005-0095	6005-0096	6005-0097	6005-0069	6005-0099
Door gasket made of FKM (temperature resistant up to 200 °C / 392 °F) <i>optional ED, FD</i>	8012-0493	8012-0494	8012-0495	8012-0496	8012-0497	8012-0498
Stable table on wheels with castors and locking brakes	--	9051-0018	9051-0018	9051-0019	9051-0019	--
Chamber fuse 5x20mm 250V 10A semi time lag (M)	5006-0012	5006-0012	5006-0012	5006-0012	5006-0012	5006-0012
Chamber fuse 5x20mm 250V 16A semi time lag (M) <i>ED, FD</i>	--	--	--	5006-0013	--	--
Rubber pads for safe stacking (4 pc.)	8012-0001	8012-0001	8012-0001	--	--	--

Description	Art. No.
Data logger kit T 220	8012-0715
Data logger kit T 350	8012-0714
Data logger software	8012-0821
Neutral cleaning agent, 1 kg	1002-0016

Chamber type	BD	ED	FD
Validation service	Art.-Nr.		
Qualification folder IQ-OQ	8012-0870	8012-0761	8012-0792
Qualification folder IQ-OQ-PQ	8012-0958	8012-0942	8012-0943
Execution of IQ-OQ	DL400100	DL400100	DL400100
Execution of IQ-OQ-PQ	DL440500	DL440500	DL440500
Calibration service	Art.-Nr.		
Calibration of temperature including certificate (1 measuring point)	DL300101	DL300101	DL300101
Spatial temperature measurement including certificate (9 measuring points)	DL300109	DL300109	DL300109
Spatial temperature measurement including certificate (18 measuring points)	DL300118	DL300118	DL300118
Spatial temperature measurement including certificate (27 measuring points)	DL300127	DL300127	DL300127
Measurement of air ventilation acc. to ASTM D 5374, including certificate	--	DL330000	DL330000

For information on components not listed here, please contact BINDER Service.

13. Certificates and declarations of conformity

13.1 EU Declaration of Conformity for BD



Best conditions for your success



EU-Konformitätserklärung / EU Declaration of Conformity / Déclaration de conformité UE / Declaración de conformidad UE / Dichiarazione di conformità UE / Декларация соответствия EU

Hersteller / Manufacturer / Fabricant / Fabricante / Fabbricante / Производитель	BINDER GmbH
Anschrift / Address / Adresse / Dirección / Indirizzo / Адрес	Im Mittleren Ösch 5, 78532 Tuttlingen, Germany
Produkt / Product / Produit / Producto / Prodotto / Продукт	Inkubatoren mit freier Konvektion Incubators with natural convection Incubateurs à convection naturelle Incubadoras de convección natural Incubatori a convezione naturale Инкубаторы с естественной конвекцией
Typenbezeichnung / Type / Type / Tipo / Tipo / Тип	BD 23, BD 400, BD 720

Die oben beschriebenen Maschinen sind konform mit folgenden EG/EU-Richtlinien (gemäß Veröffentlichung im Amtsblatt der europäischen Kommission):

The machines described above are in conformity with the following EC/EU Directives (as published in the Official Journal of the European Union):

Les machines décrites ci-dessus sont conformes aux directives CE/UE suivantes (selon leur publication dans le Journal officiel de l'Union européenne):

La máquina descrita arriba cumple con las siguientes directivas de la CE/UE (publicados en el Diario oficial de la Unión Europea):

Le macchine sopra descritte sono conforme alle seguenti direttive CE/UE (secondo la pubblicazione nella Gazzetta ufficiale della Commissione europea):

Машина, указанная выше, полностью соответствует следующим регламентам EC/EU (опубликованным в Официальном журнале Европейского Содружества):

- **2006/42/EC**
Maschinenrichtlinie 2006/42/EG / Machinery directive 2006/42/EC / Directive Machines 2006/42/EC / Directiva 2006/42/CE (Máquinas) / Direttiva macchine 2006/42/CE / Директива о машинах 2006/42/EC
- **2014/30/EU**
EMV-Richtlinie 2014/30/EU / EMC Directive 2014/30/EU / Directive CEM 2014/30/UE / Directiva CEM 2014/30/UE / Direttiva EMC 2014/30/UE / Директива ЭМС 2014/30/EU
- **2011/65/EU**
RoHS-Richtlinie 2011/65/EU / RoHS Directive 2011/65/EU / Directive RoHS 2011/65/UE / Directiva RoHS 2011/65/UE / Direttiva RoHS 2011/65/UE / Директива RoHS 2011/65/EU

1 / 3

BINDER GmbH Postfach 102 D-78502 Tuttlingen **Anschrift:** BINDER GmbH Im Mittleren Ösch 5 D-78532 Tuttlingen
Kontakt: Telefon: +49 (0) 74 62 / 20 05 - 0 | Telefax: +49 (0) 74 62 / 20 05 - 100 | info@binder-world.com | www.binder-world.com
Geschäftsführung: Dipl.-Ing. Peter M. Binder | Amtsgericht Stuttgart, HRB 727150 | Sitz der Gesellschaft: Tuttlingen
Bankverbindung: Kreissparkasse Tuttlingen Konto-Nr.: 2266 BLZ: 643 500 70 | IBAN-Code: DE05643 500700 000002266 | SWIFT-Code: SOLA DE S1TUT
S-Account 2202 611 55 | IBAN-Code: DE7464350070 0220 261155 | SWIFT-Code: SOLA DE S1TUT
 Deutsche Bank Tuttlingen Konto-Nr.: 2 138 709 BLZ: 653 700 75 | IBAN-Code: DE56653 70075 0213870900 | SWIFT-Code: DEUT DE SS603
 Altgeräte-Entsorgung gemäß WEEE-Reg.-Nr. DE 37004983

Die oben beschriebenen Maschinen entsprechen aufgrund ihrer Konzipierung und Bauart sowie in der von uns in Verkehr gebrachten Ausführung den einschlägigen grundlegenden Sicherheits- und Gesundheitsanforderungen der genannten EG/EU-Richtlinien.

The machines described above are conform to the mentioned EC/EU directives in regard to the relevant safety and health demands due to their conception and style of construction as well as to the version put onto market by us.

Les machines décrites ci-dessus correspondent aux demandes de sécurité et de santé des directives citées de la CE/UE due à leur conception et construction et dans la réalisation mise sur le marché par nous.

Las máquinas descritas arriba se corresponden con los requisitos básicos pertinentes de seguridad y salud de las citadas directivas de la CE/UE debido a su concepción y fabricación, así como a la realización llevada a cabo por nosotros.

Le macchine sopra descritte sono conforme ai requisiti essenziali di sanità e sicurezza pertinenti delle summenzionate direttive CE/UE in termini di progettazione, tipo di costruzione ed esecuzione messa da noi in circolazione.

Машины описано выше, соответствует указанным директивам ЕС/ЕУ в отношении требований соответствующей безопасности и здоровья по концепции и конструкции так же как и версия, применяемая нами на рынке.

Die oben beschriebenen Maschinen tragen entsprechend die Kennzeichnung CE.

The machines described above, corresponding to this, bear the CE-mark.

Les machines décrits ci-dessus, en correspondance, portent l'indication CE.

Las máquinas descritas arriba, en conformidad, llevan la indicación CE.

Le macchine sopra descritte sono contrassegnate dal marchio CE.

Машины описано выше, в соответствии с изложенным выше маркированы знаком CE.

Die oben beschriebenen Maschinen sind konform mit folgenden harmonisierten Normen:

The machines described above are in conformity with the following harmonized standards:

Les machines décrits ci-dessus sont conformes aux normes harmonisées suivantes:

Las máquinas descritas arriba cumplen con las siguientes normas:

Le macchine sopra descritte sono conforme alle seguenti normative armonizzate:

Машины описано выше, полностью соответствуют следующим стандартам:

Sicherheit / Safety / Sécurité / Seguridad / Sicurezza / Нормативы по безопасности

- EN ISO 12100:2010 + Corr. 1:2011
- EN ISO 13732-1:2008
- EN 60204-1:2006 + A1:2009 + Corr. :2010

EMV / EMC / CEM / CEM / EMC / ЭМС

- EN 61326-1:2013

RoHS

- EN 50581:2012

2 / 3

BINDER GmbH Postfach 102 D-78502 Tuttlingen **Anschrift:** BINDER GmbH Im Mittleren Ösch 5 D-78532 Tuttlingen
Kontakt: Telefon: +49 (0) 74 62 / 20 05 - 0 | Telefax: +49 (0) 74 62 / 20 05 - 100 | info@binder-world.com | www.binder-world.com
Geschäftsführung: Dipl.-Ing. Peter M. Binder | Amtsgericht Stuttgart, HRB 727150 | Sitz der Gesellschaft: Tuttlingen
Bankverbindung: Kreissparkasse Tuttlingen Konto-Nr.: 2266 BLZ: 643 500 70 | IBAN-Code: DE05643 500700 000002266 | SWIFT-Code: SOLA DE 51TUT
S-Account 2202 611 55 | IBAN-Code: DE7464350070 0220 261155 | SWIFT-Code: SOLA DE 51TUT
Deutsche Bank Tuttlingen Konto-Nr.: 2 138 709 BLZ: 653 700 75 | IBAN-Code: DE56653 70075 0213870900 | SWIFT-Code: DEUT DE 55603
Altgeräte-Entsorgung gemäß WEEE-Reg.-Nr. DE 37004983

78532 Tuttlingen, 28.05.2018

BINDER GmbH



P. M. Binder

Geschäftsführender Gesellschafter

Managing Director

Directeur général

Director general

Direttore Generale

Директор



J. Bollaender

Leiter F & E und Dokumentationsbevollmächtigter

Director R & D and documentation representative

Chef de service R&D et autorisé de documentation

Responsable I & D y representante de documentación

Direttore R & D e responsabile della documentazione

Глава департамента R&D представитель документации

3 / 3

BINDER GmbH Postfach 102 D-78502 Tuttlingen **Anschrift:** BINDER GmbH Im Mittleren Ösch 5 D-78532 Tuttlingen
Kontakt: Telefon: +49 (0) 74 62 / 20 05 - 0 | Telefax: +49 (0) 74 62 / 20 05 - 100 | info@binder-world.com | www.binder-world.com
Geschäftsführung: Dipl.-Ing. Peter M. Binder | Amtsgericht Stuttgart, HRB 727150 | Sitz der Gesellschaft: Tuttlingen
Bankverbindung: Kreissparkasse Tuttlingen Konto-Nr.: 2266 BLZ: 643 500 70 | IBAN-Code: DE05643 500700 000002266 | SWIFT-Code: SOLA DE S1TUT
S-Account 2202 611 55 | IBAN-Code: DE7464350070 0220 261155 | SWIFT-Code: SOLA DE S1TUT
Deutsche Bank Tuttlingen Konto-Nr.: 2 138 709 BLZ: 653 700 75 | IBAN-Code: DE56653 70075 0213870900 | SWIFT-Code: DEUT DE 55603
Altgeräte-Entsorgung gemäß WEEE-Reg.-Nr. DE 37004983

13.2 EU Declaration of Conformity for ED



CE EU-Konformitätserklärung / EU Declaration of Conformity / Déclaration de conformité
 UE / Declaración de conformidad UE / Dichiarazione di conformità UE / Декларация
 соответствия EU

Hersteller / Manufacturer / Fabricant / Fabricante / Fabricante / Производитель	BINDER GmbH
Anschrift / Address / Adresse / Dirección / Indirizzo / Адрес	Im Mittleren Ösch 5, 78532 Tuttlingen, Germany
Produkt / Product / Produit / Producto / Prodotto / Продукт	Trocken- und Wärmeschränke mit freier Konvektion Drying and heating ovens with natural convection Etuves de chauffage et de séchage à convection naturelle Estufas de secado y calentamiento de convección natural Stufe per essiccazione e riscaldamento a convezione naturale Сушильные и сухожаровые шкафы с естественной конвекцией
Typenbezeichnung / Type / Type / Tipo / Tipo / Тип	ED 23, ED 400, ED 720

Die oben beschriebenen Maschinen sind konform mit folgenden EG/EU-Richtlinien (gemäß Veröffentlichung im Amtsblatt der europäischen Kommission):

The machines described above are in conformity with the following EC/EU Directives (as published in the Official Journal of the European Union):

Les machines décrites ci-dessus sont conformes aux directives CE/UE suivantes (selon leur publication dans le Journal officiel de l'Union européenne):

La máquina descrita arriba cumple con las siguientes directivas de la CE/UE (publicados en el Diario oficial de la Unión Europea):

Le macchine sopra descritte sono conforme alle seguenti direttive CE/UE (secondo la pubblicazione nella Gazzetta ufficiale della Commissione europea):

Машина, указанная выше, полностью соответствует следующим регламентам ЕС/ЕУ (опубликованным в Официальном журнале Европейского Содружества):

- **2006/42/EC**
 Maschinenrichtlinie 2006/42/EG / Machinery directive 2006/42/EC / Directive Machines 2006/42/EC / Directiva 2006/42/CE (Máquinas) / Direttiva macchine 2006/42/CE / Директива о машинах 2006/42/EC
- **2014/30/EU**
 EMV-Richtlinie 2014/30/EU / EMC Directive 2014/30/EU / Directive CEM 2014/30/UE / Directiva CEM 2014/30/UE / Direttiva EMC 2014/30/UE / Директива ЭМС 2014/30/EU
- **2011/65/EU**
 RoHS-Richtlinie 2011/65/EU / RoHS Directive 2011/65/EU / Directive RoHS 2011/65/UE / Directiva RoHS 2011/65/UE / Direttiva RoHS 2011/65/UE / Директива RoHS 2011/65/EU

1 / 3

BINDER GmbH Postfach 102 D-78502 Tuttlingen **Anschrift:** BINDER GmbH Im Mittleren Ösch 5 D-78532 Tuttlingen
Kontakt: Telefon: +49 (0) 74 62 / 20 05 - 0 | Telefax: +49 (0) 74 62 / 20 05 - 100 | info@binder-world.com | www.binder-world.com
Geschäftsführung: Dipl.-Ing. Peter M. Binder | Amtsgericht Stuttgart, HRB 727150 | Sitz der Gesellschaft: Tuttlingen
Bankverbindung: Kreissparkasse Tuttlingen Konto-Nr.: 2266 BLZ: 643 500 70 | IBAN-Code: DE05643 500700 000002266 | SWIFT-Code: SOLA DE S1TUT
 \$-Account 2202 611 55 | IBAN-Code: DE7464350070 0220 261155 | SWIFT-Code: SOLA DE S1TUT
 Deutsche Bank Tuttlingen Konto-Nr.: 2 138 709 BLZ: 653 700 75 | IBAN-Code: DE56653 70075 0213870900 | SWIFT-Code: DEUT DE SS603
 Altgeräte-Entsorgung gemäß WEEE-Reg.-Nr. DE 37004983

Die oben beschriebenen Maschinen entsprechen aufgrund ihrer Konzipierung und Bauart sowie in der von uns in Verkehr gebrachten Ausführung den einschlägigen grundlegenden Sicherheits- und Gesundheitsanforderungen der genannten EG/EU-Richtlinien.

The machines described above are conform to the mentioned EC/EU directives in regard to the relevant safety and health demands due to their conception and style of construction as well as to the version put onto market by us.

Les machines décrites ci-dessus correspondent aux demandes de sécurité et de santé des directives citées de la CE/UE due à leur conception et construction et dans la réalisation mise sur le marché par nous.

Las máquinas descritas arriba se corresponden con los requisitos básicos pertinentes de seguridad y salud de las citadas directivas de la CE/UE debido a su concepción y fabricación, así como a la realización llevada a cabo por nosotros.

Le macchine sopra descritte sono conforme ai requisiti essenziali di sanità e sicurezza pertinenti delle summenzionate direttive CE/UE in termini di progettazione, tipo di costruzione ed esecuzione messa da noi in circolazione.

Машины описано выше, соответствует указанным директивам ЕС/ЕУ в отношении требований соответствующей безопасности и здоровья по концепции и конструкции так же как и версия, применяемая нами на рынке.

Die oben beschriebenen Maschinen tragen entsprechend die Kennzeichnung CE.

The machines described above, corresponding to this, bear the CE-mark.

Les machines décrits ci-dessus, en correspondance, portent l'indication CE.

Las máquinas descritas arriba, en conformidad, llevan la indicación CE.

Le macchine sopra descritte sono contrassegnate dal marchio CE.

Машины описано выше, в соответствии с изложенным выше маркированы знаком CE.

Die oben beschriebenen Maschinen sind konform mit folgenden harmonisierten Normen:

The machines described above are in conformity with the following harmonized standards:

Les machines décrits ci-dessus sont conformes aux normes harmonisées suivantes:

Las máquinas descritas arriba cumplen con las siguientes normas:

Le macchine sopra descritte sono conforme alle seguenti normative armonizzate:

Машины описано выше, полностью соответствуют следующим стандартам:

Sicherheit / Safety / Sécurité / Seguridad / Sicurezza / Нормативы по безопасности
<ul style="list-style-type: none"> • EN ISO 12100:2010 + Corr. 1:2011 • EN ISO 13732-1:2008 • EN 60204-1:2006 + A1:2009 + Corr. :2010
EMV / EMC / CEM / CEM / EMC / ЭМС
<ul style="list-style-type: none"> • EN 61326-1:2013
RoHS
<ul style="list-style-type: none"> • EN 50581:2012

78532 Tuttlingen, 28.05.2018

BINDER GmbH



P. M. Binder

Geschäftsführender Gesellschafter
Managing Director
Directeur général
Director general
Direttore Generale
Директор



J. Bollaender

Leiter F & E und Dokumentationsbevollmächtigter
Director R & D and documentation representative
Chef de service R&D et autorisé de documentation
Responsable I & D y representante de documentación
Direttore R & D e responsabile della documentazione
Глава департамента R&D представитель документации

3 / 3

BINDER GmbH Postfach 102 D-78502 Tuttlingen **Anschrift:** BINDER GmbH Im Mittleren Ösch 5 D-78532 Tuttlingen
Kontakt: Telefon: +49 (0) 74 62 / 20 05 - 0 | Telefax: +49 (0) 74 62 / 20 05 - 100 | info@binder-world.com | www.binder-world.com
Geschäftsführung: Dipl.-Ing. Peter M. Binder | Amtsgericht Stuttgart, HRB 727150 | Sitz der Gesellschaft: Tuttlingen
Bankverbindung: Kreissparkasse Tuttlingen Konto-Nr.: 2266 BLZ: 643 500 70 | IBAN-Code: DE05643 500700 000002266 | SWIFT-Code: SOLA DE S1TUT
\$-Account 2202 611 55 | IBAN-Code: DE7464350070 0220 261155 | SWIFT-Code: SOLA DE S1TUT
Deutsche Bank Tuttlingen Konto-Nr.: 2 138 709 BLZ: 653 700 75 | IBAN-Code: DE56653 70075 0213870900 | SWIFT-Code: DEUT DE 55603
Altgeräte-Entsorgung gemäß WEEE-Reg.-Nr. DE 37004983

13.3 EU Declaration of Conformity for FD



CE EU-Konformitätserklärung / EU Declaration of Conformity / Déclaration de conformité
UE / Declaración de conformidad UE / Dichiarazione di conformità UE / Декларация
соответствия EU

Hersteller / Manufacturer / Fabricant / Fabricante / Fabbricante / Производитель	BINDER GmbH
Anschrift / Address / Adresse / Di- rección / Indirizzo / Адрес	Im Mittleren Ösch 5, 78532 Tuttlingen, Germany
Produkt / Product / Produit / Pro- ducto / Prodotto / Продукт	Trocken- und Wärmeschränke mit Umluft Drying and heating ovens with forced convection Etuves de chauffage et de séchage à convection forcée Estufas de secado y calentamiento de convección forzada Stufe per essiccazione e riscaldamento a convezione forzata Сушильные и сухожаровые шкафы с принудительной конвекцией
Typenbezeichnung / Type / Type / Tipo / Tipo / Тип	FD 23

Die oben beschriebenen Maschinen sind konform mit folgenden EG/EU-Richtlinien (gemäß Veröffentlichung im Amtsblatt der europäischen Kommission):

The machines described above are in conformity with the following EC/EU Directives (as published in the Official Journal of the European Union):

Les machines décrites ci-dessus sont conformes aux directives CE/UE suivantes (selon leur publication dans le Journal officiel de l'Union européenne):

La máquina descrita arriba cumple con las siguientes directivas de la CE/UE (publicados en el Diario oficial de la Unión Europea):

Le macchine sopra descritte sono conforme alle seguenti direttive CE/UE (secondo la pubblicazione nella Gazzetta ufficiale della Commissione europea):

Машина, указанная выше, полностью соответствует следующим регламентам ЕС/ЕУ (опубликованным в Официальном журнале Европейского Содружества):

- **2006/42/EC**
Maschinenrichtlinie 2006/42/EG / Machinery directive 2006/42/EC / Directive Machines 2006/42/EC / Directiva 2006/42/CE (Máquinas) / Direttiva macchine 2006/42/CE / Директива о машинах 2006/42/EC
- **2014/30/EU**
EMV-Richtlinie 2014/30/EU / EMC Directive 2014/30/EU / Directive CEM 2014/30/UE / Directiva CEM 2014/30/UE / Direttiva EMC 2014/30/UE / Директива ЭМС 2014/30/EU
- **2011/65/EU**
RoHS-Richtlinie 2011/65/EU / RoHS Directive 2011/65/EU / Directive RoHS 2011/65/UE / Directiva RoHS 2011/65/UE / Direttiva RoHS 2011/65/UE / Директива RoHS 2011/65/EU

1 / 3

BINDER GmbH Postfach 102 D-78502 Tuttlingen **Anschrift:** BINDER GmbH Im Mittleren Ösch 5 D-78532 Tuttlingen
Kontakt: Telefon: +49 (0) 74 62 / 20 05 – 0 | Telefax: +49 (0) 74 62 / 20 05 – 100 | info@binder-world.com | www.binder-world.com
Geschäftsführung: Dipl.-Ing. Peter M. Binder | Amtsgericht Stuttgart, HRB 727150 | Sitz der Gesellschaft: Tuttlingen
Bankverbindung: Kreissparkasse Tuttlingen Konto-Nr.: 2266 BLZ: 643 500 70 | IBAN-Code: DE05643 500700 000002266 | SWIFT-Code: SOLA DE S1TUT
S-Account 2202 611 55 | IBAN-Code: DE7464350070 0220 261155 | SWIFT-Code: SOLA DE S1TUT
Deutsche Bank Tuttlingen Konto-Nr.: 2 138 709 BLZ: 653 700 75 | IBAN-Code: DE56653 70075 0213870800 | SWIFT-Code: DEUT DE SS603
Altgeräte-Entsorgung gemäß WEEE-Reg.-Nr. DE 37004983

Die oben beschriebenen Maschinen entsprechen aufgrund ihrer Konzipierung und Bauart sowie in der von uns in Verkehr gebrachten Ausführung den einschlägigen grundlegenden Sicherheits- und Gesundheitsanforderungen der genannten EG/EU-Richtlinien.

The machines described above are conform to the mentioned EC/EU directives in regard to the relevant safety and health demands due to their conception and style of construction as well as to the version put onto market by us.

Les machines décrites ci-dessus correspondent aux demandes de sécurité et de santé des directives citées de la CE/UE due à leur conception et construction et dans la réalisation mise sur le marché par nous.

Las máquinas descritas arriba se corresponden con los requisitos básicos pertinentes de seguridad y salud de las citadas directivas de la CE/UE debido a su concepción y fabricación, así como a la realización llevada a cabo por nosotros.

Le macchine sopra descritte sono conforme ai requisiti essenziali di sanità e sicurezza pertinenti delle summenzionate direttive CE/UE in termini di progettazione, tipo di costruzione ed esecuzione messa da noi in circolazione.

Машины описано выше, соответствует указанным директивам ЕС/ЕУ в отношении требований соответствующей безопасности и здоровья по концепции и конструкции так же как и версия, применяемая нами на рынке.

Die oben beschriebenen Maschinen tragen entsprechend die Kennzeichnung CE.

The machines described above, corresponding to this, bear the CE-mark.

Les machines décrits ci-dessus, en correspondance, portent l'indication CE.

Las máquinas descritas arriba, en conformidad, llevan la indicación CE.

Le macchine sopra descritte sono contrassegnate dal marchio CE.

Машины описано выше, в соответствии с изложенным выше маркированы знаком CE.

Die oben beschriebenen Maschinen sind konform mit folgenden harmonisierten Normen:

The machines described above are in conformity with the following harmonized standards:

Les machines décrits ci-dessus sont conformes aux normes harmonisées suivantes:

Las máquinas descritas arriba cumplen con las siguientes normas:

Le macchine sopra descritte sono conforme alle seguenti normative armonizzate:

Машины описано выше, полностью соответствуют следующим стандартам:

Sicherheit / Safety / Sécurité / Seguridad / Sicurezza / Нормативы по безопасности
<ul style="list-style-type: none"> • EN ISO 12100:2010 + Corr. 1:2011 • EN ISO 13732-1:2008 • EN 60204-1:2006 + A1:2009 + Corr. :2010
EMV / EMC / CEM / CEM / EMC / ЭМС
<ul style="list-style-type: none"> • EN 61326-1:2013
RoHS
<ul style="list-style-type: none"> • EN 50581:2012

2 / 3

BINDER GmbH Postfach 102 D-78502 Tuttlingen **Anschrift:** BINDER GmbH Im Mittleren Ösch 5 D-78532 Tuttlingen
Kontakt: Telefon: +49 (0) 74 62 / 20 05 – 0 | Telefax: +49 (0) 74 62 / 20 05 – 100 | info@binder-world.com | www.binder-world.com
Geschäftsführung: Dipl.-Ing. Peter M. Binder | Amtsgericht Stuttgart, HRB 727150 | Sitz der Gesellschaft: Tuttlingen
Bankverbindung: Kreissparkasse Tuttlingen Konto-Nr.: 2266 BLZ: 643 500 70 | IBAN-Code: DE05643 500700 000002266 | SWIFT-Code: SOLA DE S1TUT
S-Account 2202 611 55 | IBAN-Code: DE7464350070 0220 261155 | SWIFT-Code: SOLA DE S1TUT
 Deutsche Bank Tuttlingen Konto-Nr.: 2 138 709 BLZ: 653 700 75 | IBAN-Code: DE56653 70075 0213870900 | SWIFT-Code: DEUT DE SS603
 Altgeräte-Entsorgung gemäß WEEE-Reg.-Nr. DE 37004983

78532 Tuttlingen, 28.05.2018

BINDER GmbH

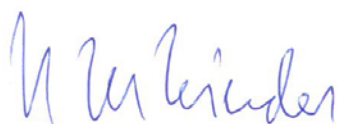

P. M. Binder

Geschäftsführender Gesellschafter
Managing Director
Directeur général
Director general
Direttore Generale
Директор



J. Bollaender

Leiter F & E und Dokumentationsbevollmächtigter
Director R & D and documentation representative
Chef de service R&D et autorisé de documentation
Responsable I & D y representante de documentación
Direttore R & D e responsabile della documentazione
Глава департамента R&D представитель документации

3 / 3

BINDER GmbH Postfach 102 D-78502 Tuttlingen **Anschrift:** BINDER GmbH Im Mittleren Ösch 5 D-78532 Tuttlingen
Kontakt: Telefon: +49 (0) 74 62 / 20 05 - 0 | Telefax: +49 (0) 74 62 / 20 05 - 100 | info@binder-world.com | www.binder-world.com
Geschäftsführung: Dipl.-Ing. Peter M. Binder | Amtsgericht Stuttgart, HRB 727150 | Sitz der Gesellschaft: Tuttlingen
Bankverbindung: Kreissparkasse Tuttlingen Konto-Nr.: 2266 BLZ: 643 500 70 | IBAN-Code: DE05643 500700 000002266 | SWIFT-Code: SOLA DE S1TUT
S-Account 2202 611 55 | IBAN-Code: DE7464350070 0220 261155 | SWIFT-Code: SOLA DE S1TUT
Deutsche Bank Tuttlingen Konto-Nr.: 2 138 709 BLZ: 653 700 75 | IBAN-Code: DE56653 70075 0213870900 | SWIFT-Code: DEUT DE 55603
Altgeräte-Entsorgung gemäß WEEE-Reg.-Nr. DE 37004983

13.4 Certificate for the GS mark of conformity of the "Deutsche Gesetzliche Unfallversicherung e.V." (German Social Accident Insurance) DGUV

Zertifikat
Nr. **NV 18098**
vom 29.05.2018

 **DGUV Test**
Prüf- und Zertifizierungsstelle
Nahrungsmittel und Verpackung
Fachbereich Nahrungsmittel

GS-Zertifikat

Name und Anschrift des
Zertifikatsinhabers:
(Auftraggeber)

Binder GmbH
Im Mittleren Ösch 5
78532 Tuttlingen

Produktbezeichnung: **Klimaschränke Inkubatoren, Trocken- und Wärmeschränke**

Typ: BD 23, BD 400, BD 720, BF 400, BF 720, ED 23, ED 400, ED 720,
FD 23, FED 400, FED 720

Prüfgrundlage: GS-NV 2:2017/09 Prüfgrundsätze für Nahrungsmittelmachines

Zugehöriger Prüfbericht: Prüfbericht zum Zertifikat NV 18098

Weitere Angaben: Das Zertifikat bezieht sich auf die im zugehörigen Prüfbericht beschriebene Ausführung des Produkts.

Das geprüfte Baumuster stimmt mit den in § 21 Absatz 1 des Produktsicherheitsgesetzes genannten Anforderungen überein. Der Zertifikatsinhaber ist berechtigt, das umseitig abgebildete GS-Zeichen an den mit dem geprüften Baumuster übereinstimmenden Produkten anzubringen. Der Zertifikatsinhaber hat dabei die umseitig aufgeführten Bedingungen zu beachten.

Dieses Zertifikat einschließlich der Berechtigung zur Anbringung des GS-Zeichens ist gültig bis einschließlich:

28.05.2023

Weiteres über die Gültigkeit, eine Gültigkeitsverlängerung und andere Bedingungen regelt die Prüf- und Zertifizierungsordnung.



PZB04_D
09.16

Deutsche Gesetzliche Unfallversicherung (DGUV) e.V.
Spitzenverband der gewerblichen Berufsgenossenschaften
und der Unfallversicherungsträger der öffentlichen Hand
Vereinsregister-Nr. VR 751 B, Amtsgericht Charlottenburg

DGUV Test Prüf- und Zertifizierungsstelle Nahrungsmittel und Verpackung
Fachbereich Nahrungsmittel
Dynamostraße 7-11 • 68165 Mannheim • Deutschland
Telefon: +49 (0) 6 21 44 56-34 30 • Fax: +49 (0) 800 1977 553 16625

Rückseite GS-Zertifikat: NV 18098

GS-Zeichen



Normalausführung



Bei einer Höhe von 20 mm oder weniger
auch zulässige Ausführung

1. Der Zertifikatsinhaber hat die Voraussetzungen einzuhalten, die bei der Herstellung des umseitig genannten Produktes zu beachten sind, um die Übereinstimmung mit dem geprüften Baumuster zu gewährleisten.
2. Die Prüf- und Zertifizierungsstelle des Fachbereichs Nahrungsmittel führt in regelmäßigen Abständen Kontrollmaßnahmen zur Überwachung der Herstellung und rechtmäßigen Verwendung des GS-Zeichens durch.
3. Die für die Herstellung verantwortliche Person hat sich zur Einhaltung der Voraussetzungen nach Nummer 1 und Duldung der Kontrollmaßnahmen verpflichtet.
4. Die Prüf- und Zertifizierungsstelle entzieht dem Zertifikatsinhaber die Zuerkennung des GS-Zeichens, wenn sich die Anforderungen nach § 21 Absatz 1 Produktsicherheitsgesetz geändert haben oder die Voraussetzungen nach Nummer 1 nicht eingehalten werden.
5. Das GS-Zeichen darf nur verwendet und mit ihm darf nur geworben werden, wenn die Voraussetzungen nach § 22 Produktsicherheitsgesetz erfüllt sind.

14. Product registration

Online Product Registration

Register your **BINDER** now!

www.binder-world.com/register

The registration is free and takes just a few seconds

Advantages:

- ▶ Short response times if service is needed
- ▶ Fair prices when relocating or installing equipment
- ▶ Calibration as required at no charge in case of recalls
- ▶ Free information on news, product upgrades and accessories

Easy registered in 3 steps:



1. List serial number here:

-

2. Go online: www.binder-world.com/register

3. Register serial number

15. Contamination clearance certificate

15.1 For chambers located outside the USA and Canada

Declaration with regard to safety and health

Erklärung zur Sicherheit and gesundheitlichen Unbedenklichkeit

The German Ordinance on Hazardous Substances (GefStofV), and the regulations regarding safety at the workplace, require that this form be filled out for all products that are returned to us, so that the safety and health of our employees can be warranted.

Die Sicherheit und Gesundheit unserer Mitarbeiter, die Gefahrstoffverordnung GefStofV und die Vorschriften zur Sicherheit am Arbeitsplatz machen es erforderlich, dass dieses Formblatt für alle Produkte, die an uns zurückgeschickt wird.



In the absence of a completely filled out form, a repair is not possible.
Ohne Vorliegen des vollständig ausgefüllten Formblattes ist eine Reparatur nicht möglich.

- A completely filled out form should be transmitted by Fax (+49 (0) 7462 2005 93555) or by letter in advance to us, so that this information is available before the equipment/component part arrives. A second copy of this form should accompany the equipment/component part. Eventually the carrier should be informed.

Eine vollständig ausgefüllte Kopie dieses Formblattes soll per Telefax (Nr. +49 (0) 7462 2005 93555) oder Brief vorab an uns gesandt werden, so dass die Information vorliegt, bevor das Gerät/Bauteil eintrifft. Eine weitere Kopie soll dem Gerät/Bauteil beigelegt sein. Ggf. ist auch die Spedition zu informieren.

- Incomplete information or non-conformity with this procedure will inevitably lead to substantial delays in processing. We hope you will have understanding for this measure, which lies outside of our area of influence, and that you will help us to speed up this procedure.

Unvollständige Angaben oder Nichteinhalten dieses Ablaufs führen zwangsläufig zu beträchtlichen Verzögerungen in der Abwicklung. Bitte haben Sie Verständnis für Maßnahmen, die außerhalb unserer Einflussmöglichkeiten liegen und helfen Sie mit, den Ablauf beschleunigen.

- **Please fill out this form completely.**

Bitte unbedingt vollständig ausfüllen!

1.	Unit/ component part / type: / Gerät / Bauteil / Typ:
2.	Serial No./ Serien-Nr.:
3.	Details about utilized substances / biological substances / Einzelheiten über die eingesetzten Substanzen/biologische Materialien:
3.1	Designations / Bezeichnungen:
a)	_____
b)	_____
c)	_____
3.2	Safety measures required for handling these substances / Vorsichtsmaßnahmen beim Umgang mit diesen Stoffen:
a)	_____
b)	_____
c)	_____

3.3	Measures to be taken in case of skin contact or release into the atmosphere / Maßnahmen bei Personenkontakt oder Freisetzung:
a)	_____
b)	_____
c)	_____
d)	_____
3.4	Other important information that must be taken into account / Weitere zu beachtende und wichtige Informationen:
a)	_____
b)	_____
c)	_____
4.	Declaration on the risk of these substances (please checkmark the applicable items) / Erklärung zur Gefährlichkeit der Stoffe (bitte Zutreffendes ankreuzen) :
<input type="checkbox"/>	4.1 For non toxic, non radioactive, biologically harmless materials / für nicht giftige, nicht radioaktive, biologisch ungefährliche Stoffe:
	We herewith guarantee that the above-mentioned unit / component part... / Wir versichern, dass o.g. Gerät/Bauteil...
<input type="checkbox"/>	Has not been exposed to or contains any toxic or otherwise hazardous substances / weder giftige noch sonstige gefährliche Stoffe enthält oder solche anhaften.
<input type="checkbox"/>	That eventually generated reaction products are non-toxic and also do not represent a hazard / auch evtl. entstandene Reaktionsprodukte weder giftig sind noch sonst eine Gefährdung darstellen.
<input type="checkbox"/>	Eventual residues of hazardous substances have been removed / evtl. Rückstände von Gefahrstoffen entfernt wurden.
<input type="checkbox"/>	4.2 For toxic, radioactive, biologically harmful or hazardous substances, or any other hazardous materials / für giftige, radioaktive, biologisch bedenkliche bzw. gefährliche Stoffe oder anderweitig gefährliche Stoffe.
	We herewith guarantee that ... / Wir versichern, dass ...
<input type="checkbox"/>	The hazardous substances, which have come into contact with the above-mentioned equipment/component part, have been completely listed under item 3.1 and that all information in this regard is complete / die gefährlichen Stoffe, die mit dem o.g. Gerät/Bauteil in Kontakt kamen, in 3.1 aufgelistet sind und alle Angaben vollständig sind.
<input type="checkbox"/>	That the unit /component part has not been in contact with radioactivity / das Gerät/Bauteil nicht mit Radioaktivität in Berührung kam
5.	Kind of transport / transporter / Transportweg/Spediteur:
	Transport by (means and name of transport company, etc.) Versendung durch (Name Spediteur o.ä.)

	Date of dispatch to BINDER GmbH / Tag der Absendung an BINDER GmbH:

We herewith declare that the following measures have been taken / Wir erklären, dass folgende Maßnahmen getroffen wurden:

- Hazardous substances were removed from the unit / component part, so that no hazard exists for corresponding persons in the handling or repair of these items / das Gerät/Bauteil wurde von Gefahrstoffen befreit, so dass bei Handhabung/Reparaturen für die betreffenden Person keinerlei Gefährdung besteht
- The unit was securely packaged and properly identified / das Gerät wurde sicher verpackt und vollständig gekennzeichnet.
- Information about the hazardousness of the shipment (if required) has been provided to the transporter / der Spediteur wurde (falls vorgeschrieben) über die Gefährlichkeit der Sendung informiert.

We herewith commit ourselves and guarantee that we will indemnify BINDER GmbH for all damages that are a consequence of incomplete or incorrect information provided by us, and that we will exempt BINDER GmbH from eventual damage claims by third parties./ Wir versichern, dass wir gegenüber BINDER für jeden Schaden, der durch unvollständige und unrichtige Angaben entsteht, haften und BINDER gegen eventuell entstehende Schadenansprüche Dritter freistellen.

We are aware that, in accordance with Article 823 of the German Civil Code (BGB), we are directly liable with regard to third parties, in this instance especially the employees of BINDER GmbH, who have been entrusted with the handling / repair of the unit / component. / Es ist uns bekannt, dass wir gegenüber Dritten – hier insbesondere mit der Handhabung/Reparatur des Geräts/des Bauteils betraute Mitarbeiter der Firma BINDER - gemäß §823 BGB direkt haften

Name: _____

Position: _____

Date / Datum: _____

Signature / Unterschrift: _____

Company stamp / Firmenstempel:



Equipment that is returned to the factory for repair must be accompanied by a completely filled out contamination clearance certificate. For service and maintenance works on site, such a contamination clearance certificate must be submitted to the service technician before the start of the works. No repair or maintenance of the equipment is possible, without a properly filled out contamination clearance certificate.

15.2 For chambers located in the USA and Canada

Product Return Authorization Request

Please complete this form and the Customer Decontamination Declaration (next 2 pages) and attach the required pictures. E-mail to: IDL_SalesOrderProcessing_USA@binder-world.com

After we have received and reviewed the complete information we will decide on the issue of a RMA number. Please be aware that size specifications, voltage specifications as well as performance specifications are available on the internet at www.binder-world.us at any time.

Take notice of shipping laws and regulations.

	Please fill:	
Reason for return request	<input type="radio"/> Duplicate order	
	<input type="radio"/> Duplicate shipment	
	<input type="radio"/> Demo	<i>Page one completed by sales</i>
	<input type="radio"/> Power Plug / Voltage	115V / 230 V / 208 V / 240V
	<input type="radio"/> Size does not fit space	
	<input type="radio"/> Transport Damage	Shock watch tripped? (<i>pictures</i>)
	<input type="radio"/> Other (specify below)	

Is there a replacement PO?	<input type="radio"/> Yes <input type="radio"/> No	
	<i>If yes -> PO #</i>	
	<i>If yes -> Date PO placed</i>	
Purchase order number		
BINDER model number		
BINDER serial number		
Date unit was received		
Was the unit unboxed?	<input type="radio"/> Yes <input type="radio"/> No	
Was the unit plugged in?	<input type="radio"/> Yes <input type="radio"/> No	
Was the unit in operation?	<input type="radio"/> Yes <input type="radio"/> No	
<i>Pictures of unit attached?</i>	<input type="radio"/> Yes <input type="radio"/> No	Pictures have to be attached!
<i>Pictures of Packaging attached?</i>	<input type="radio"/> Yes <input type="radio"/> No	

	Customer Contact Information	Distributor Contact Information
Name		
Company		
Address		
Phone		
E-mail		

Customer (End User) Decontamination Declaration

Health and Hazard Safety declaration

To protect the health of our employees and the safety at the workplace, we require that this form is completed by the user for all products and parts that are returned to us. (Distributors or Service Organizations cannot sign this form)

	<p>NO RMA number will be issued without a completed form. Products or parts returned to our NY warehouse without a RMA number will be refused at the dock.</p>
---	--

A second copy of the completed form must be attached to the outside of the shipping box.

1.	Unit/ component part / type:
2.	Serial No.
3.	List any exposure to hazardous liquids, gasses or substances and radioactive material
3.1	List with MSDS sheets attached where available or needed (if there is not enough space available below, please attach a page):
a)	_____
b)	_____
c)	_____
3.2	Safety measures required for handling the list under 3.1
a)	_____
b)	_____
c)	_____
3.3	Measures to be taken in case of skin contact or release into the atmosphere:
a)	_____
b)	_____
c)	_____
d)	_____
3.4	Other important information that must be considered:
a)	_____
b)	_____
c)	_____

4. Declaration of Decontamination

For toxic, radioactive, biologically and chemically harmful or hazardous substances, or any other hazardous materials.

We hereby guarantee that

- 4.1 Any hazardous substances, which have come into contact with the above-mentioned equipment / component part, have been completely listed under item 3.1 and that all information in this regard is complete.
- 4.2 That the unit /component part has not been in contact with radioactivity
- 4.3 Any Hazardous substances were removed from the unit / component part, so that no hazard exists for a persons in the shipping, handling or repair of these returned unit
- 4.4 The unit was securely packaged in the original undamaged packaging and properly identified on the outside of the packaging material with the unit designation, the RMA number and a copy of this declaration.
- 4.5 Shipping laws and regulations have not been violated.

I hereby commit and guarantee that we will indemnify BINDER Inc for all damages that are a consequence of incomplete or incorrect information provided by us, and that we will indemnify and hold harmless BINDER Inc. from eventual damage claims by third parties.

Name: _____

Position: _____

Company: _____

Address: _____

Phone #: _____

Email: _____

Date: _____

Signature: _____



Equipment returned to the NY warehouse for repair must be accompanied by a completed customer decontamination declaration. For service and maintenance works on site, such a customer decontamination declaration must be submitted to the service technician before the start of work. No repair or maintenance of the equipment is possible without a completed form.

