



PREPARATIVE & ANALYTICAL ULTRACENTRIFUGES

PRECISION-MADE PERFORMANCE

PRODUCT CATALOG



BRILLIANCE
at every turn.

 **BECKMAN
COULTER**
Life Sciences

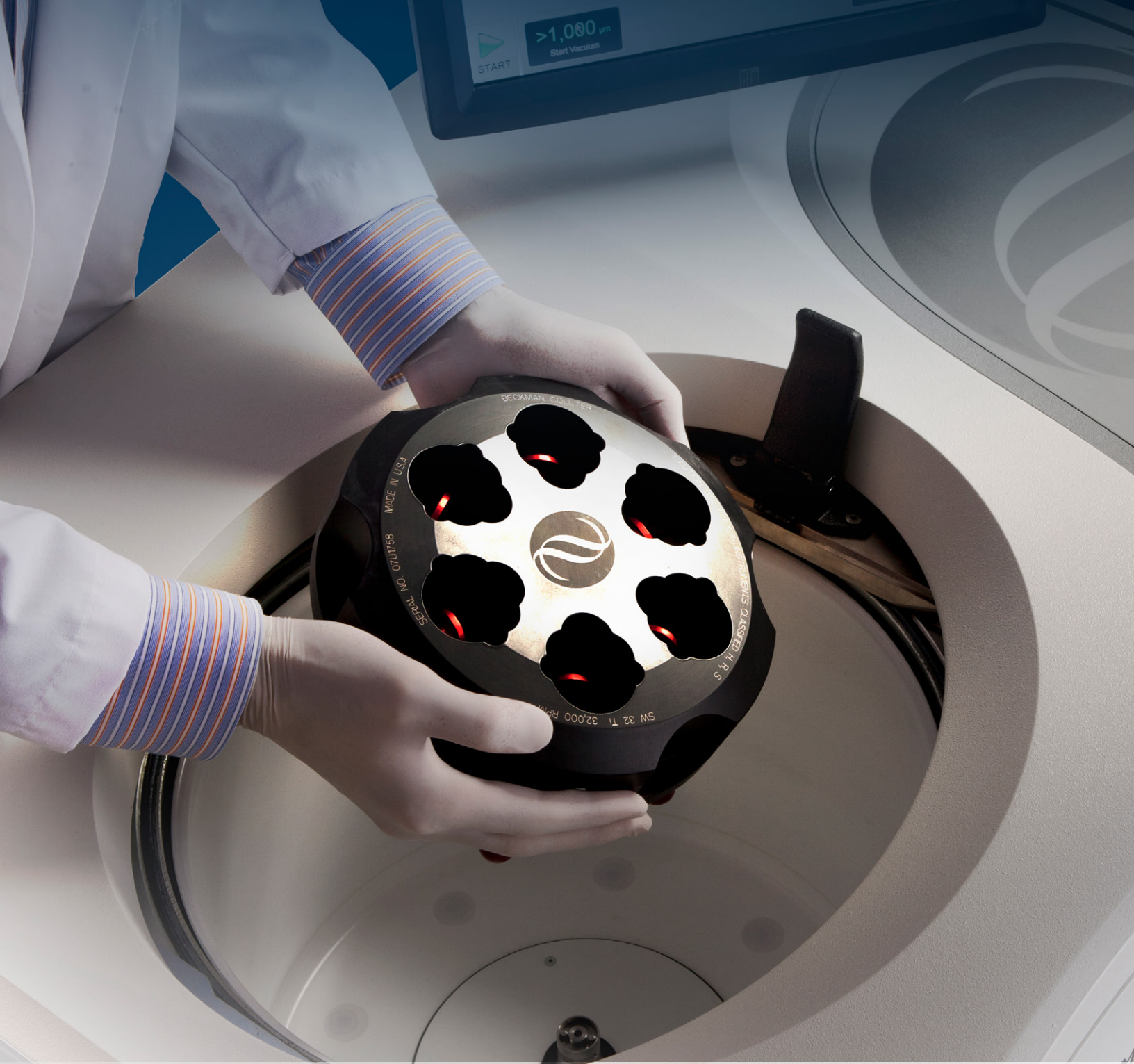



ULTRA POWERFUL SO QUIET
SOPHISTICATED MULTILINGUAL
INTELLIGENT ALWAYS SECURE
SYSTEMATIC EXCELLENCE

Since the introduction of the first commercial ultracentrifuge in 1947 — the classic Beckman Model L — Beckman Coulter has been at the forefront of centrifuge innovation. Although the physics of this basic separation technique never change, Beckman Coulter continually designs new and innovative rotors and accessories, and develops advanced methods that allow the forces of centrifugation to be applied in new ways.

This centrifuge product selection guide is designed to help you determine the most efficient centrifuge tools for your laboratory.

Each section begins with a brief description of instruments that Beckman Coulter offers within that centrifuge category. Because biocontainment and sterility are major concerns in today's laboratories, Beckman Coulter provides a number of options that address this issue. Special BioSafe instruments and accessories are available across our centrifuge product line and are identified with the following icons:

 **BioSafe and BioSafety** are terms intended to describe the enhanced biocontainment features of our products.

 **BioCertified** is a term used to describe our products which have been tested and validated to demonstrate containment of microbiological aerosols by an independent, third-party facility (Health Protection Agency, Porton Down, UK). Improper use or maintenance may affect seal integrity and, thus, containment.

 **BioEnhanced** is a term intended to describe our products' enhanced level of biocontainment by design.

Rotors with the BioCertified symbol have been tested to demonstrate containment of aerosols under normal operating conditions of the associated Beckman Coulter centrifuge when used and maintained as instructed.

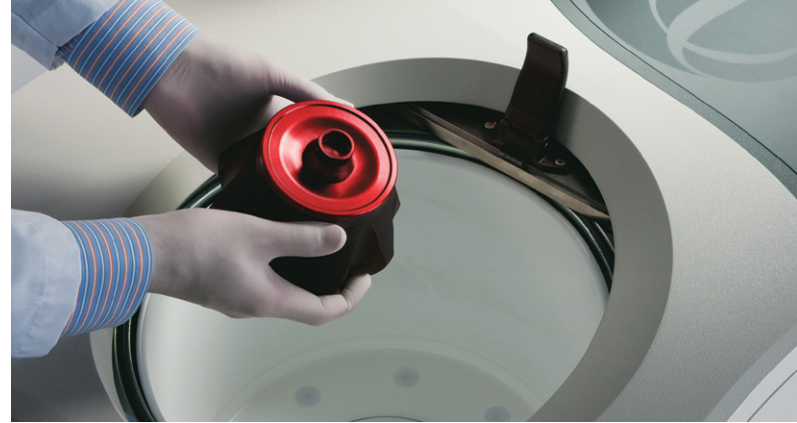

Following the centrifuge descriptions, listings of their rotors are included with information on speed and g-force capability. Also included is information on tubes and bottles that can be used and the adapters they require.

Tubes and bottles are cross-referenced in a separate section which provides details on tube materials, chemical compatibility, tube designs, and tube closure options.

A reference section at the back of the guide includes quick-reference charts on instrument and tube selection, as well as frequently used formulas.

 Contact your local Beckman Coulter office
Please visit us at beckman.com/contact-us
Additional centrifugation resources:
beckman.com/centrifugation

Disclaimer: The content included in this catalog is for reference purposes only. The most accurate and up-to-date information is located in Instrument and Rotor Instructions For Use which are available at beckman.com/techdocs

1. Analytical Ultracentrifugation

Optima AUC.....	1-1
-----------------	-----

2. Floor Prep Ultracentrifugation

Optima X Series Floor Model Preparative Ultracentrifuge.....	2-1
---	------------

Quick-Reference Guide for Rotor Specifications for Floor Model Ultracentrifuges	2-3
--	-----

Fixed-Angle Rotors

Type 100 Ti	2-4
Type 90 Ti	2-5
Type 70.1 Ti	2-6
Type 70 Ti	2-7
Type 50.4 Ti	2-8
Type 50.2 Ti	2-9
Type 45 Ti	2-10
Type 42.2 Ti	2-11
Type 25	2-12
Type 19	2-13

NVT Near-Vertical Tube Rotors

NVT 100	2-14
NVT 90	2-15
NVT 65.2	2-16
NVT 65	2-17

Vertical Tube Rotors

VTi 90	2-18
VTi 65.2	2-19
VTi 65.1	2-20
VTi 50	2-21

Swinging-Bucket Rotors

SW 60 Ti	2-22
SW 55 Ti	2-23
SW 41 Ti	2-24
SW 40 Ti	2-25
SW 32.1 Ti	2-26
SW 32 Ti	2-27
SW 28.1	2-28
SW 28	2-29

Continuous-Flow Rotors

CF-32 Ti	2-30
----------------	------

Zonal Rotors

Ti-15	2-31
Seal Assembly	2-32

3. Tabletop Ultracentrifugation

Optima MAX Series Tabletop Preparative Ultracentrifuges.....	3-1
---	------------

Quick-Reference Guide to Rotor Specifications and Tabletop Ultracentrifuge Compatibility	3-3
---	-----

Fixed-Angle Rotors

TLA-120.2	3-4
TLA-120.1	3-5
TLA-110	3-6
TLA-100.3	3-7
TLA-100	3-8
TLA-55	3-9
MLA-150	3-10
MLA-130	3-11
MLA-80	3-12
MLA-55	3-13
MLA-50	3-15

NVT Near-Vertical Tube Rotors

TLN-120	3-16
TLN-100	3-17
MLN-80	3-18

Swinging-Bucket Rotors

TLS-55	3-19
MLS-50	3-20

4. Micro-Ultracentrifugation

Airfuge Air-Driven Micro-Ultracentrifuge	4-1
---	------------

Quick-Reference Guide to Airfuge Rotors	4-1
---	-----

Fixed-Angle Rotors

A-110	4-2
A-100/30	4-2
A-100/18	4-3
A-95	4-3

Additional Rotors

ACR-90	4-4
Batch Rotor	4-4
EM-90	4-5

5. Tubes

Tubes and Bottles For Every Application	5-1
Compatibility of Tube Material with Solvents and Sample.....	5-2
Gradient Formation and Fractionation.....	5-2
High Temperature Centrifugation	5-2
Tube Sizes	5-2
Tube Cleaning, Sterilization, and Reuse	5-2

Tube Selection Considerations

Tube Closures.....	5-3
OptiSeal Tubes	5-3
Quick-Seal Tubes.....	5-3
A Quick-Reference Chart to Tube Materials and Their Properties.....	5-4
Sterile and Certified Free Tubes.....	5-5
Tubes and Bottles (Listed by Volume)	5-6
Bottle Assemblies with Three-Piece Caps	5-9
Tube Cap Assemblies and Parts	5-10

6. Accessories

Tools and Supplies for Preparative Ultracentrifuge Rotors

Tools for Fixed-Angle Rotors.....	6-2
Tools for Vertical-Tube and NVT Rotors.....	6-4
Tools for Swinging-Bucket Rotors	6-4

Tools and Accessories for Quick-Seal Tubes

Supplies.....	6-5
Tools for Quick-Seal Tubes	6-5
Tools for OptiSeal Tubes	6-6
Quick-Seal Tube Racks.....	6-6
Cordless Tube Topper	6-7
CentriTube Slicer—for Micro Ultracentrifuge Tubes	6-8
Tube Slicer—for Preparative Ultracentrifuge Tubes	6-8
Rotor Cleaning Kit	6-9
Fraction Recovery System	6-10

7. Reference

Ultracentrifuge Reference Information	7-1
The Importance of <i>k</i> Factor.....	7-2
Rotor Material.....	7-2
Swinging-Bucket (SW) Rotors.....	7-2
Fixed-Angle (FA) Rotors.....	7-2
Vertical-Tube (VT) Rotors.....	7-2
Near-Vertical Tube (NVT) Rotors.....	7-2
Continuous-Flow/Zonal Rotors.....	7-2

How to Choose a Rotor

Particle Separation in Swinging-Bucket, Fixed-Angle, Near-Vertical Tube, and Vertical-Tube Rotors.....	7-3
--	-----

Gradient Materials

Commonly Used Gradient Materials with Their Solvents.....	7-5
Density, Refractive Index, and Concentration Data - Cesium Chloride at 25°C, Molecular Weight = 168.37	7-6
Density, Refractive Index, and Concentration Data - Sucrose at 20°C, Molecular Weight = 342.3.....	7-7
Density Conversion for Cesium and Rubidium Salts at 20°C - Sucrose at 20°C, Molecular Weight = 342.3.....	7-8
Useful Formulas	7-9

8. Support

Field Service Support.....	8-1
Field Rotor Inspection Program.....	8-1
Rotor Safety Seminars	8-1
On-Site Rotor Inspection and Maintenance.....	8-1
A Comprehensive Approach to Centrifuge System Care	8-1

ANALYTICAL ULTRACENTRIFUGATION

Optima AUC



Beckman Coulter delivered the first AUC sample characterization tool to the scientific community powering discoveries. The tradition continues into the 21st century with the new Optima AUC system. This latest offering is the most robust technology for providing protein molecular weight in basic protein research and quantification of aggregation levels for academic and biopharma research.

Analytical ultracentrifugation is the most versatile, rigorous and accurate means for determining the molecular weight, hydrodynamic and thermodynamic properties of a protein or other macromolecule. Currently, there is no other technique capable of providing the same range of information with a comparable level of precision and accuracy.

Common AUC Applications

- Molecular Weight
- Stoichiometry
- Protein Aggregation
- Ligand Binding
- Polydispersity
- Viral Vectors
- Plasmids
- Exosomes/Liposomes
- Nanoparticles
- Antibodies & conjugates
- Polymers
- Synthetics



Specifications	
Optical Systems	
Fastest Data Acquisition Rate	ABS: <7 sec/sector* INT: <5 sec/scan
Max # of Wavelengths	20
Wavelength Precision	+/- 0.5 nm
Lowest Radial Resolution	10 µm
Absorbance Flash Lamp Frequency	300 Hz
CCD Camera Specifications	2048 x 1088 pixels
Interference Fringes	≥ 10 fringes/cell
Usable Concentration Ranges	ABS: .005 - -1-2 mg/mL Luteinizing Hormone INT: .025 - -4-5 mg/mL BSA
Hardware	
Operating System	LINUX Remote GUI (any operating system)
Remote Experimental Setup, Monitoring, and Data Export	Yes
Display	15 inches
Sample Temperature Control Accuracy	+/- 0.5°C**
Sample Temperature Range	0-40°C***
Optical Architecture	Open, Modular (up to 3 detection capabilities at once)

* At optimal rotor speeds, at 10 µm radial resolution
 ** After reaching temperature equilibrium
 *** Environmental temperature must be less than 25°C to reach below 4°C

What detection method do I need?

Absorbance system: when my analyte has a chromophore.

Interference system: otherwise or when I need to collect data very quickly.

Instruments and Sales Groups



Part No.	Description
B86438	Optima AUC - Absorbance Only
B86437	Optima AUC - ABS/INT
C00707	Optima AUC - ABS Bundle + An-60 + Cell 392772 + Starter Kit
C00708	Optima AUC - ABS/INT Bundle + An-60 + Cell 392772 + Starter Kit
C00709	Optima AUC - ABS Bundle + An-50 + Cell 392772 + Starter Kit
C00710	Optima AUC - ABS/INT Bundle + An-50 + Cell 392772 + Starter Kit

* For Starter Kit contents, see chart to the right

Not intended or validated for use in the diagnosis of disease or other conditions.



Rotors

Part No.	Description	
363782	AN-50 8-hole Rotor (50,000RPM)	
361964	AN-60 4-hole Rotor (60,000RPM)	
354457	Optional HEPA Filter Kit	

Optima AUC Starter Kit

Part No.	Description
362106	Starter Kit
Starter Kit above includes the following:	
361318	Torque Stand Assembly
362327	Cell Housing Plug (package of 6)
301922	Screw Ring for Cell Housing (Black)
362328	Screw Ring Gasket (package of 6)
302194	Gasket Rod
362340	Cell Aligning/Removal Tool
362329	Window Liner, Bakelite (package of 6)
306812	Spinkote™ Lubricant • For metal threads.
360219	Counterbalance, 1.3 cm • Note: Model E counterbalance is incompatible with XL-A.
327021	Window Gasket, White Vinylite (package of 100)
327022	Cell Plug Gasket, Red Polyethylene (package of 100)
807371	Screwdriver for Housing Plug
961332	Tubing & Needle, Luer Lock, CTFE (quantity 3)
961524	Cabinet, 15 Drawer
360529	Applicator Tool



Torque Stand Assembly
361318



Counterbalance Cell
360219

ANALYTICAL ULTRACENTRIFUGATION

Cell Assembly Configurations

Part No.	Description
2-Channel Velocity Cell Assemblies	
392773	Individual Assembled Cell (Sapphire Windows) with Flow-Through Centerpiece Includes: Set of 2 Sapphire Windows, Cell Housing (2 Sector Al), 12mm Charcoal Filled Epon Centerpiece, Plug Gasket, Plug Housing, Screw Ring, Screw Ring Washer, Window gasket, Window liner, and Window holder
392772	Individual Assembled Cell (Quartz Windows) with Flow-Through Centerpiece Includes: Set of 2 Quartz Windows, Cell Housing (2 Sector Al), 12mm Charcoal Filled Epon Centerpiece, Plug Gasket, Plug Housing, Screw Ring, Screw Ring Washer, Window gasket, Window liner, and Window holder
A37301	Complete Aluminum Cell with Quartz Windows Includes: Cell housing and Quartz Window Assembly kit, Al metal centerpiece, gaskets (pkg 10)
A37302	Complete Aluminum Cell with Sapphire Windows Includes: Cell housing and Sapphire Window Assembly kit, Al metal centerpiece, gaskets (pkg 10)
6-Channel Equilibrium Cell Assemblies	
A37296	6-Channel Internal Fill Cell and Quartz Windows Includes: 6-channel cell housing, 6-channel centerpiece and Quartz Window Assembly kit
A37297	6-Channel Internal Fill Cell with Sapphire Windows Includes: 6-channel cell housing, 6-channel centerpiece and Sapphire Window Assembly kit

NOTE:
Epon Charcoal rated up to 42,000 RPM
Aluminum cells rated up to up to 60,000 RPM

ALL-in-ONE Cell Packs

These are sales groups of the most common types of cell assemblies. All Centerpieces are Epon-Charcoal unless mentioned otherwise.

Part No.	Description
A37294	6-Channel Flow-Through Cell with Quartz Windows Includes: External fill 6-channel cell housing, External fill 6-channel centerpiece and Quartz Window Assembly kit
A37295	6-Channel Flow-Through Cell with Sapphire Windows Includes: External fill 6-channel cell housing, External fill 6-channel centerpiece and Sapphire Window Assembly kit
A37296	6-Channel Internal Fill Cell and Quartz Windows Includes: 6-channel cell housing, 6-channel centerpiece and Quartz Window Assembly kit
A37297	6-Channel Internal Fill Cell with Sapphire Windows Includes: 6-channel cell housing, 6-channel centerpiece and Sapphire Window Assembly kit
A37298	8-Channel Internal Fill Cell with Quartz Windows Includes: 6-channel cell housing, 8-channel centerpiece and Quartz Window Assembly kit
A37299	8-Channel Internal Fill Cell with Sapphire Windows Includes: 6-channel cell housing, 8-channel centerpiece and Sapphire Window Assembly kit
High Concentration Accessories - Requires Spacer 2X 333717	
A37292	3 mm Centerpiece with Quartz Windows Includes: 3 mm Centerpiece kit, Cell housing and Quartz Window Assembly kit
A37293	3 mm Centerpiece with Sapphire Windows Includes: 3 mm Centerpiece kit, Cell housing and Sapphire Window Assembly kit



IMPORTANT:

Window materials recommended for specific detection methods:

- Quartz windows can be used ONLY for Absorbance analysis
- Sapphire windows must be used for Interference analysis, but also can be used for Absorbance as well

Cell Accessories Common to Double, Six-, and Eight-Sector Cells

Part No.	Description
Accessory Kit	
392777	Accessory Kit, includes brass housing plugs (qty/6)
Accessory Kit above includes the following:	
362327	Cell Housing Plug (package of 6)
327022	Cell Plug Gasket, Red Polyethylene (package of 100)
362340	Cell Aligning/Removal Tool
327021	Window Gasket, White Vinylite (package of 100)
306812	Spinkote™ Lubricant, for metal threads

Cell Housing Kits

Part No.	Description
366037	Cell Housing and Sapphire Window Assembly Kit For double-sector cells Kit includes 2 each sapphire window assemblies and 1 each cell housing assembly (requires centerpiece) Recommended for work with the Rayleigh Interference Optics System Not recommended for absorbance work below 235 nm
334606	Cell Housing and Window Assembly Kit For double-sector cells, 12 mm; plane quartz window Kit includes an upper window and a lower window assembly (requires centerpiece)
334602	Cell Housing Assembly Kit For double-sector cells (requires two window assemblies and one centerpiece)

IMPORTANT:

Window materials recommended for specific detection methods:

- Quartz windows can be used ONLY for Absorbance analysis
- Sapphire windows must be used for Interference analysis, but also can be used for Absorbance as well

Window Assemblies and Accesories

Part No.	Description
334597	Complete Plane Quartz Window Assembly Kit Consisting of a window holder, window gasket, window liner and plane quartz window (each cell assembly requires two window assemblies)
334641	Sapphire Windows Assembly Kit For double-sector cells (requires two window assemblies and one centerpiece) Includes window holder, window gasket, window liner, and a sapphire window Recommended for work with the Rayleigh Interference Optics system Not recommended for absorbance work below 235 nm
305037	Window Holder (each)
327021	Window Gasket, White Vinylite (package of 100)
362329	Window Liner, Bakelite (package of 6)
301730	Window, Plane Quartz, Replacement
307177	Sapphire Window Replacement Recommended for work with the Rayleigh Interference Optics system Not recommended for absorbance work below 190 nm
301922	Screw Ring for Cell Housing (Black)
362328	Screw Ring Gasket (package of 6)
362327	Cell Housing Plug (package of 6)
327022	Cell Plug Gasket, Red Polyethylene (package of 100)

Miscellaneous

Part No.	Description
361318	Torque Stand Assembly
338009	Instrument Calibration Solutions (package of 4)
360241	Counterbalance Only (Body Assembly) Without weights

ANALYTICAL ULTRACENTRIFUGATION

Centerpieces for the An-50 Ti and An-60 Ti Cells

Type	Material	Part No.	Fill Volume (mL)	Recommended Maximum Speed (RPM)
2-channel Sedimentation Velocity (SV)	 Aluminum Single-Fill Hole	334623	0.45 per sector	60,000
	 Epon charcoal-filled Flow-Through	392778	0.45 per sector	42,000
	 Epon charcoal-filled Single-Fill Hole	306493	0.45 per sector	42,000
	 Epon aluminum-filled Single-Fill Hole	305685	0.45 per sector	42,000
	 3-mm Epon charcoal-filled Single-Fill Hole	361966 ^a	0.12 per sector	42,000
2-channel Synthetic Boundary Capillary-type (external fill)	 Epon charcoal-filled	331431	0.4 solvent 0.15 sample	42,000
	 Epon aluminum-filled	306076	0.4 solvent 0.15 sample	42,000
2-channel Band Forming (external fill)	 Epon charcoal-filled	331359	0.01 per well 0.35 per sector	42,000
6-channel Equilibrium (external fill)	 Epon charcoal-filled	331376 ^b	0.12 per channel	48,000
8-channel Equilibrium (external fill)	 Epon charcoal-filled	361851	0.025 per channel	50,000
6-channel Equilibrium	 Epon charcoal-filled Single-Fill Hole	368116 ^c	0.12 per channel	48,000

- a Two spacers (333717) required
- b Housing kit (335402) required
- c Housing kit (368115) required.

NOTE:
Flow-through centerpieces have 2 filling holes per sector
Single-fill hole centerpieces have 1 filling hole per sector

ANALYTICAL ULTRACENTRIFUGATION

Cell Assembly - Expanded View of Components for 12- and 3-mm centerpieces

12-mm Centerpieces		Additional Components for 3-mm Centerpieces	
	Screw Ring (301922)		
	Screw-Ring Washer (362328)		
			Spacer (333717)
	Window Holder (305037)		
	Window Gasket (327021)		
	Window Liner (362329)		
	Window quartz (301730) sapphire (307177)		
	Gasket (aluminum centerpiece only) (330446)		
	Select Centerpiece (see page 1-5)		
	Gasket (aluminum centerpiece only) (330446)		
	Window quartz (301730) sapphire (307177)		
	Window Liner (362329)		
	Window Gasket (327021)		
	Window Holder (305037)		
			Spacer (333717)
	Select Cell Housing (see page 1-4)		

1. Analytical UC
2. Floor Prep UC
3. Tabletop UC
4. Micro-UC
5. Tubes
6. Accessories
7. Reference
8. Support

FLOOR PREP ULTRACENTRIFUGATION

Optima X Series Floor Model Preparative Ultracentrifuge



Experience the visibility and control of our intelligent user interface that makes the Optima X Series a breeze to operate. Our entry-level model, the XE delivers all of the features required to quickly set up and complete a run. Our premium model, the XPN, boasts networking capability and a variety of customizable security and tracking features, ensuring chain of custody and compliance. Both models feature multi-layered BioSafety features in order to maintain a safe working environment. And, as you have come to expect, all instruments are designed as a total system with our innovative rotors and labware.

Large touch-screen display

Easy to read and navigate. Viewable from across the lab. Intuitive graphical interface with on-screen help. Multilingual software supporting 9 major languages. Touchscreen size approximately 15in (38cm).

Remote monitoring and control (XPN only)

Saves time. Start, stop, and monitor from computer or smart phone. Receive diagnostic alerts via e-mail. iPhone or Android compatible.

Energy efficient

Maintains runs during power fluctuations Regenerative braking returns energy to local circuit. Highly efficient thermoelectric cooling results in lower power consumption. Idle state energy usage equivalent to a 60 Watt light bulb

Powerful on-board simulation and calculation tools (XPN only)

Saves time and samples. Proprietary software optimizes protocols before running to ensure maximum efficiency. Quickly perform common calculations and conversions.

Security and tracking features (XPN only)

Manage rotor life by serial number. Track detailed usage history. Password protection and electronic signatures help you maintain chain of custody and compliance.

Quiet-drive technology

Designed for low drive noise. Operates at less than 51 dBA.



Model	Part Numbers*			
	Instrument		BioSafe Package** 	
	IVD	Non-IVD	IVD	Non-IVD
Optima XPN-100	A99846	A94469	B10053	B10048
Optima XPN-90	A99842	A94468	B10052	B10047
Optima XPN-80	A99839	A95765	B10051	B10046
Optima XE-100	A99836	A94516	B10050	B10045
Optima XE-90	A99833	A94471	B10049	B10044

* Availability varies by geography. Contact your local sales representative to determine the correct part number for ordering.

** BioSafe Package includes centrifuge and HEPA/Pharmaceutical-Grade Sterilizing filter kit PN 354457.

1. Analytical UC
2. Floor Prep UC
3. Tabletop UC
4. Micro-UC
5. Tubes
6. Accessories
7. Reference
8. Support

FLOOR PREP ULTRACENTRIFUGATION

Features	Optima XPN	Optima XE
Giant LCD touchscreen display. Approximately 15 inch (38 cm)	●	●
Intuitive, multilingual interface	●	●
Improved power tolerance	●	●
Compatible with existing Beckman Coulter rotors	●	●
Step-by-step zonal/CF operation screens	●	●
Rotor tracking by serial number	●	
User defined programs	●	
Remote monitoring and control	●	
Password protection and three user access levels	●	
Exportable run logs and electronic signatures	●	
eXPert simulation software	●	
Speed/temperature vs. time plot	●	

Specifications		
	Optima XPN	Optima XE
Maximum speed (rpm)	100,000 90,000 80,000	100,000 90,000
Maximum RCF (x g)	802,400 694,000 548,300	802,400 694,000
Speed control	± 2 rpm of set speed (above 1,000 rpm)	
Set temperature	0 to 40°C in 1°C increments	
Temperature control	± 0.5°C of set temperature*	
Ambient operating range	10 to 35°C	
Accel/decel profiles	10 accel/11 decel	
Braking	Regenerative, power reclamation	
Operating languages	English, French, Italian, German, Spanish, Japanese, Russian, Korean, and Chinese (Simplified)	
Advanced software	Optima eXPert calculations, simulations, references	No
User-defined programs	1,000 with to 30 steps each	No
User profiles	50 unique users and passwords	No
Electronic signature	Yes	No
Rotor tracking	By serial number	No
Data transfer	(3) USB 2.0 type A connectors, (1) RJ-45 connector	No
Heat output	3400 Btu/hr (1.0 kW)	
Drive cooling	Air-cooled	
Refrigeration system	Thermoelectric - no CFCs, ODCs	
Sound level	<51 dBA	
Remote control	Available	No
HEPA filter	Available (Pharmaceutical-Grade Sterilizing Filter)	
Power requirement	200-240 VAC, 30 A, 50/60 Hz	
Dimensions (H x W x D)	125.7 x 94 x 68.1 cm 49.5 x 37 x 26.8 in	
Weight	485 kg (1068 lb)	

* ± 0.8°C when using SW 32 swinging bucket rotor.

FLOOR PREP ULTRACENTRIFUGATION

Quick-Reference Guide for Rotor Specifications for Floor Model Ultracentrifuges

Rotor	P/N	Max. RPM	Max.g	k Factor	No of Tubes x Nominal Tube volume (mL)	Nominal Rotor Capacity (mL)
Fixed-Angle Rotors						
Type 100 Ti	363013	100 000	802 000	15	8 x 6.8	54
Type 90 Ti	355530	90 000	694 000	25	8 x 13.5	108
Type 70.1 Ti	342184	70 000	450 000	36	12 x 13.5	162
Type 70 Ti	337922	70 000	504 000	44	8 x 39	312
Type 50.4 Ti	347299	50 000	270 000 312 000	39 33	44 x 6.5	286
Type 50.2 Ti	337901	50 000	302 000	69	12 x 39	468
Type 45 Ti	339160	45 000	235 000	133	6 x 94	564
Type 42.2 Ti	343007	42 000	223 000	12	72 x 230 µL	16.5
Type 25 Ti	347261	25 000	70 300 81 400 92 500	84 71 62	100 x 1	100
Type 19 Ti	325620	19 000	53 900	951	6 x 250	1500
Near-Vertical Rotors						
NVT 100	365898	100 000	750 000	8	8 x 5.1	40.8
NVT 90	362752	90 000	645 000	10	8 x 5.1	40.8
NVT 65.2	361073	65 000	416 000	15	16 x 5.1	81.6
NVT 65	362755	65 000	402 000	21	8 x 13.5	108
Vertical Rotors						
VTi 90	362751	90 000	645 000	6	8 x 5.1	40.8
VTi 65.2	362754	65 000	416 000	10	16 x 5.1	81.6
VTi 65.1	362759	65 000	402 000	13	8 x 13.5	108
VTi 50	362758	50 000	242 000	36	8 x 39	312
Swinging-Bucket Rotors						
SW 60 Ti	335649	60 000	485 000	45	6 x 4	24
SW 55 Ti	342194	55 000	368 000	48	6 x 5	30
SW 41 Ti	331362	41 000	288 000	124	6 x 13.2	79.2
SW 40 Ti	331302	40 000	285 000	137	6 x 14	84
SW 32.1 Ti	369651	32 000	187 000	229	6 x 17	102
SW 32 Ti	369650	32 000	175 000	204	6 x 38.5	231
SW 28.1	342216	28 000	150 000	275	6 x 17	102
SW 28	342207	28 000	141 000	246	6 x 38.5	231
Continuous Flow & Zonal Rotors						
CF-32 Ti	350700	32 000	102 000	42	N/A	430
Ti-15	969312	32 000	102 000	481	N/A	1675

1. Analytical UC
2. Floor Prep UC
3. Tabletop UC
4. Micro-UC
5. Tubes
6. Accessories
7. Reference
8. Support

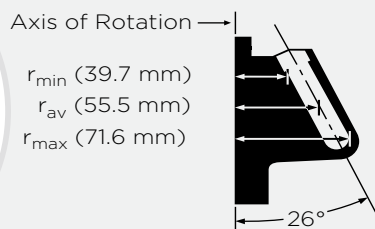

Fixed-Angle Rotor, Titanium

For use in instruments classified: R S

Major applications: Rapid separation of plasmid DNA and rapid differential centrifugation of small particles.

Max. RPM	Max. <i>g</i>	<i>k</i> Factor	Number of Tubes Volume/Size	Rotor Capacity
100 000	802 000	15	8 x 6.8 mL ½ x 2½ in 13 x 64 mm	54 mL

No. 363013. Type 100 Ti Rotor Assembly with 3 each 876089 O-rings, 3 each 839347 O-rings, and 2 each 363304 Overspeed Disks.

No. 363963. Quick-Seal Tube Kit with 4 boxes 344619 Polypropylene Tubes, 8 Spacers 365470, 1 each Tube Removal Tool 361668, Spinkote Lubricant 306812, and Vacuum Grease 335148. (Cordless Tube Topper and Tube Rack required.)

Tubes and Bottles									
Tube Style/ Material	Vol. (mL) <i>g</i> -Max	Part No.	Quantity	Size (mm)	Required Caps/ Spacers (qty. 1)	Required Adapters (qty. 1)	<i>g</i> -Force	<i>k</i> Factor	Max. Speed
Quick-Seal	2.0	345829	50	13 x 25	360270	-	802 000	7.0	55 000
Polypropylene	2.0	363962[§]	50	13 x 25	360270	-	802 000	7.0	100 000
	3.5	349621	50	13 x 30	360270	-	802 000	9.4	100 000
	3.5	363961[§]	50	13 x 32	360270	-	802 000	9.4	100 000
	5.1	362248	50	13 x 51	360270	-	802 000	13.5	100 000
	5.1	363960[§]	50	13 x 51	360270	-	802 000	13.5	100 000
	6.0	344619	50	13 x 57	365470	-	802 000	15.0	100 000

Note: To help you locate *g*-Max tubes in the rotor listings, these tubes are highlighted with bold, italic type.

§ To simplify ordering, this *g*-Max Kit includes enough spacers to fill rotor, 50 tubes and required tools.

Rotor Replacement Parts

363037	Rotor Lid
363039	Rotor Handle
363304	Overspeed Disk, 100 000 rpm
839347	O-ring for Rotor Handle
876089	O-ring for Rotor Lid

Spacers (Package of 8)

365470	fits 13 x 57 mm
360270	fits 13 x 51 mm
360270	fits 13 x 32 mm
360270	fits 13 x 25 mm
360270	fits 13 x 30 mm

Adapters/Spacers/Caps	
360270	365470

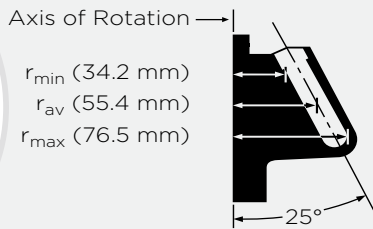

Fixed-Angle Rotor, Titanium

For use in instruments classified: H R S

Major applications: Five-hour separation of plasmid DNA and rapid differential centrifugation of small particles.

Max. RPM	Max. g	k Factor	Number of Tubes Volume/Size	Rotor Capacity
90 000	694 000	25	8 x 13.5 mL 5/8" x 3 in 16 x 76 mm	108 mL

No. 355530. Type 90 Ti Rotor Assembly with 3 each 839347 O-rings, 3 each 876089 O-rings, and 2 each 355539 Overspeed Disks.

No. 348179. Quick-Seal Tube Kit with 2 boxes 342413 Polypropylene Tubes, 2 boxes 344322 Ultra-Clear Tubes, 12 Spacers 342695, 1 each 348123 Tube Rack, 306812 Spinkote Lubricant, and 335148 Vacuum Grease. (Cordless Tube Topper Kit required; see Tools, Accessories, and Supplies.)

No. 348180. Open-Top Tube Kit with 2 boxes 326814 Polypropylene Tubes, 2 boxes 344085 Ultra-Clear Tubes, 12 Tube Caps 341968, 1 Spinkote Lubricant 306812, and 1 Vacuum Grease 335148. (331202 and 305075 Tools required; see Tools, Accessories, and Supplies.)

No. 361660. OptiSeal Tube Kit with 4 boxes of OptiSeal Tubes 361623, 12 Spacers 361670 (6 pkg. of 2), 1 OptiSeal Tube Rack 361642, 1 Tube Extraction Tool 361668, and 1 Spacer Removal Tool 338765.

Tubes and Bottles									
Tube Style/ Material	Vol. (mL) <i>g-Max</i>	Part No.	Quantity	Size (mm)	Required Caps/ Spacers (qty. 1)	Required Adapters (qty. 1)	<i>g-Force</i>	<i>k Factor</i>	Max. Speed
OptiSeal Polypropylene	8.9	361623	56	16 x 60	361670 ^{§§}	-	694 000	21	90 000
Quick-Seal Polypropylene	4.2	356562	50	16 x 38	345828	-	694 000	11	90 000
	4.2	357332[§]	50	16 x 38	345828	-	694 000	11	90 000
	6.3	345830	50	16 x 45	345828	-	694 000	14	90 000
	6.3	357334[§]	50	16 x 45	345828	-	694 000	14	90 000
	10.0	344622	50	16 x 67	344676	-	694 000	21	90 000
13.5	342413*	50	16 x 76	342695	-	694 000	25	90 000	
Quick-Seal Ultra-Clear	13.5	344322	50	16 x 76	342695	-	694 000	25	90 000
Polycarbonate Bottle/Assembly	10.4	355603	6	16 x 76	-	-	362 000	48	65 000
	10.4	355651 ^{ΔΔ}	25	16 x 76	-	-	362 000	48	65 000
Thinwall Polypropylene	6.5	326820	50	13 x 64	346256	303313	197 000	69	50 000
	13.5	326814	50	16 x 76	341968	-	548 000	32	80 000
Thickwall Polypropylene	4.0	355644	25	13 x 64	-	303313	197 000	69	50 000 ^Δ
	10.0	355640	25	16 x 76	338907 ^Δ	-	77 000	190	30 000 ^Δ
Thickwall Polycarbonate	4.0	355645	25	13 x 64	-	303313	197 000	69	50 000 ^Δ
	10.0	355630	25	16 x 76	338907 ^Δ	-	197 000	69	50 000 ^Δ
Ultra-Clear	2.0	344091	50	8 x 49	303624	303376	128 000	72	40 000
	4.0	344093	50	13 x 41	346256	303402	138 000	67	45 000
	6.5	344088*	50	13 x 64	346256	303313	197 000	69	50 000
	13.5	344085	50	16 x 76	341968	-	548 000	32	80 000
	3.0	344092	50	13 x 32	346256	30341	129 000	59	45 000

Sterile and Certified-Free Tubes												
Tube Style/ Material	Vol. (mL) <i>g-Max</i>	Size (mm)	Beckman Standard Part Number	Certified Free Part Number	Qty	Sterile Part Number	Qty	Required Caps / Spacers (qty. 1)	Required Adapters (qty. 1)	<i>g-Force</i>	<i>k Factor</i>	Max. Speed
Ultra-Clear	6.5	13 x 64	344088	C14280	50	C14296	48	346256	303313	197 000	69	50 000
Quick Seal Polypropylene	13.5	16 x 76	342413	C14290	50	C14306	48	342695	-	694 000	25	90 000

Note: To help you locate *g-Max* tubes in the rotor listings, these tubes are highlighted with bold, italic type.

§ To simplify ordering, this *g-Max* Kit includes enough spacers to fill rotor, 50 tubes and required tools.

§§ Set of 2.

Δ Maximum speeds given above are those which the tubes could withstand when tested at 25°C for 24 hours. Further tests have shown that the polycarbonate tubes can be run at 75 000 rpm for six hours or at 65 000 rpm for eight hours.

ΔΔ Bottles only.

* Sterile and C-Free options available.

Rotor Replacement Parts

355528	Lid
355529	Rotor Handle
355530	Rotor Assembly
355539	Overspeed Disk
356959	Tool, Handle
839347	O Ring, Inner
876089	O Ring, Outer

Adapters/Spacers/Caps										
303313	303376	303402	303624	338907	341968	346256	342695	344676	345828	361670

Tube Racks

348123	324 Place 5/8" Tube
361642	5/8" Bell Optiseal Tube Rack

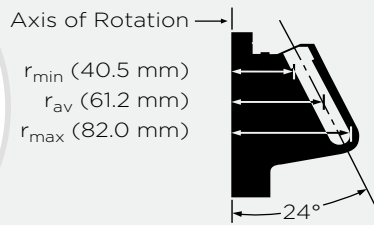

Fixed-Angle Rotor, Titanium

For use in instruments classified: H R S

Major applications: Differential centrifugation of subcellular particles.

Max. RPM	Max. g	k Factor	Number of Tubes Volume/Size	Rotor Capacity
70 000	450 000	36	12 x 13.5 mL 5/8 x 3 in 16 x 76 mm	162 mL

No. 342184. Type 70.1 Ti Rotor Assembly with 3 each 011757 O-rings, 3 each 858125 O-rings, and 2 each 335585 Overspeed Disks.

No. 348179. Quick-Seal Tube Kit with 2 boxes 342413 Polypropylene Tubes, 2 boxes 344322 Ultra-Clear Tubes, 12 Spacers 342695, 1 each 348123 Tube Rack, Spinkote Lubricant 306812, and Vacuum Grease 335148. (Cordless Tube Topper Kit required; see Tools, Accessories, and Supplies.)

No. 348180. Open-Top Tube Kit with 2 boxes 326814 Polypropylene Tubes, 2 boxes 344085 Ultra-Clear Tubes, 12 Tube Caps 341968, 1 Spinkote Lubricant 306812, and 1 Vacuum Grease 335148. (331202 and 305075 Tools required; see Tools, Accessories, and Supplies.)

No. 361660. OptiSeal Tube Kit with 4 boxes of OptiSeal Tubes 361623, 12 Spacers 361670 (6 pkg of 2), 1 OptiSeal Tube Rack 361642, 1 Tube Extraction Tool 361668, and 1 Spacer Removal Tool 338765.

Tubes and Bottles									
Tube Style/ Material	Vol. (mL) g-Max	Part No.	Quantity	Size (mm)	Required Caps/ Spacers (qty. 1)	Required Adapters (qty. 1)	g-Force	k Factor	Max. Speed
OptiSeal Polypropylene	8.9	361623	56	16 x 60	361670 ^{§§}	-	450 000	32	70 000
Quick-Seal Polypropylene	4.2	356562	50	16 x 38	345828	-	450 000	17	70 000
	4.2	357332[§]	50	16 x 38	345828	-	450 000	17	70 000
	6.3	345830	50	16 x 45	303448	-	450 000	24	70 000
	6.3	357334[§]	50	16 x 45	345828	-	450 000	24	70 000
	10.0	344622	50	16 x 67	344676	-	450 000	34	70 000
Quick-Seal Ultra-Clear	13.5	342413*	50	16 x 76	342695	-	450 000	36	70 000
	13.5	344322	50	16 x 76	342695	-	450 000	36	70 000
Polycarbonate Bottle Assembly	10.4	355603	6	16 x 76	355604	-	388 000	42	65 000
	10.4	355651 ^Δ	25	16 x 76	335257	-	388 000	42	65 000
Thinwall Polypropylene	6.5	326820	50	16 x 64	346256	303313	212 000	60	50 000
Thickwall Polypropylene	13.5	326814	50	16 x 76	341968	-	450 000	36	70 000
	4.0	355644	25	13 x 64	-	303313	212 000	60	50 000 ^Δ
8 mL no cap and 9.3 mL with cap	4.0	355640	25	16 x 76	338907 ^Δ	-	82 700	199	30 000 ^Δ
	4.0	355630	25	16 x 76	338907 ^Δ	-	230 000	71	50 000 ^Δ
Ultra-Clear	2.0	344091	50	8 x 49	303624	303376	138 000	63	45 000
	4.0	344093	50	13 x 41	346256	303402	152 000	58	45 000
	6.5	344088*	50	13 x 64	346256	303313	212 000	60	50 000
	13.5	344085	50	16 x 76	341968	-	450 000	36	70 000
	3.0	344092	50	13 x 32	346256	303401	143 000	51	45 000

Sterile and Certified-Free Tubes												
Tube Style/ Material	Vol. (mL) g-Max	Size (mm)	Beckman Standard Part Number	Certified Free Part Number	Qty	Sterile Part Number	Qty	Required Caps / Spacers (qty. 1)	Required Adapters (qty. 1)	g-Force	k Factor	Max. Speed
Ultra-Clear	6.5	13 x 64	344088	C14280	50	C14296	48	346256	303313	212 000	60	50 000
Quick Seal Polypropylene	13.5	16 x 76	342413	C14290	50	C14306	48	342695	-	450 000	36	70 000

Note: To help you locate g-Max tubes in the rotor listings, these tubes are highlighted with bold, italic type. ^Δ

[§] To simplify ordering, this g-Max Kit includes enough spacers to fill rotor, 50 tubes and required tools.

^{§§} Set of 2.

^Δ Maximum speeds given above are those which the tubes could withstand when tested at 25°C for 24 hours. Further tests have shown that the polycarbonate tubes can be run at 75 000 rpm for six hours or at 65 000 rpm for eight hours.

^{ΔΔ} Bottles only.

* Sterile and C-Free options available.

Rotor Replacement Parts

011757	O-ring for Rotor Handle
335585	Overspeed Disk, 70 000 rpm
337924	Rotor Handle
342183	Rotor Lid
858125	O-ring for Rotor Lid

Adapters/Spacers/Caps									
303313	303376	303402	303624	341968	342695	344676	345828	346256	361670

TYPE 70 Ti **BIOE**

8 x 39 mL

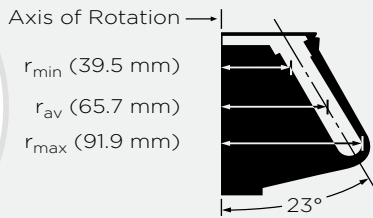

Fixed-Angle Rotor, Titanium

For use in instruments classified: H R S

Major applications: Differential centrifugation of subcellular fractions.

Max. RPM	Max. g	k Factor	Number of Tubes Volume/Size	Rotor Capacity
70 000	504 000	44	8 x 39 mL 1 x 3 1/2 in 25 x 89 mm	312 mL

No. 337922. Type 70 Ti Rotor Assembly with 3 each 011757 O-rings, 3 each 870612 O-rings, and 2 each 335585 Overspeed Disks.

No. 348178. Quick-Seal Tube Kit with 2 boxes 342414 Polypropylene Tubes, 2 boxes 344326 Ultra-Clear Tubes, 12 Spacers 342699, 1 each 348124 Tube Rack, 306812 Spinkote Lubricant, and 335148 Vacuum Grease. (Cordless Tube Topper Kit required; see Tools, Accessories, and Supplies.)

No. 348172. Open-Top Tube Kit with 4 boxes 344367 Polypropylene Tubes, 10 Tube Caps 337927, 1 Spinkote Lubricant 306812, and 1 Vacuum Grease 335148. (338841 and 305075 Tools required; see Tools, Accessories, and Supplies.)

No. 361662. OptiSeal Tube Kit with 4 boxes of OptiSeal Tubes 361625, 12 Spacers 361669 (6 pkg of 2), 1 OptiSeal Tube Rack 361646, 1 Tube Extraction Tool 361668, and 1 Spacer Removal Tool 338765.

Tubes and Bottles									
Tube Style/ Material	Vol. (mL) g-Max	Part No.	Quantity	Size (mm)	Required Caps/ Spacers (qty. 1)	Required Adapters (qty. 1)	g-Force	k Factor	Max. Speed
OptiSeal Polypropylene	32.4	361625	56	26 x 77	361669 ^{§§}	-	504 000	44	70 000
Quick-Seal Polypropylene	15.0	343664	50	25 x 38	343448	-	504 000	24	70 000
	15.0	357343[§]	50	25 x 38	343448	-	504 000	24	70 000
	27.0	343665	50	25 x 64	343448	-	504 000	31	70 000
	27.0	357346[§]	50	25 x 64	343448	-	504 000	31	70 000
	33.0	344623	50	25 x 83	344635	-	504 000	38	70 000
	39.0	342414*	50	25 x 89	342699	-	504 000	44	70 000
Quick-Seal Ultra-Clear	15.0	344324	50	25 x 38	343448	-	504 000	24	70 000
	27.0	344323	50	25 x 64	343448	-	504 000	31	70 000
	39.0	344326*	50	25 x 89	342699	-	504 000	44	70 000
Polycarbonate Bottle Assembly	26.3	355618	6	25 x 89	-	-	371 000	59	60 000
Thinwall Polypropylene	6.5	326820	50	13 x 64	346256	303392	102 000	69	45 000
	13.5	326814	50	16 x 76	330860	303307	151 000	104	40 000
	38.5	344367	50	25 x 83	337927	-	504 000	43	70 000
	38.5	326823*	50	25 x 89	331151	-	371 000	59	60 000
Thickwall Polypropylene	4.0	355644	25	13 x 64	-	303392	102 000	69	45 000
	13.5	355640	25	16 x 76	338907 [†]	303307	151 000	104	40 000
	30.0**	355642	25	25 x 89	338906 [†]	-	371 000	59	60 000
Thickwall Polycarbonate	4.0	355645	25	13 x 64	-	303392	102 000	69	45 000
	13.5	355630	25	16 x 76	338907 [†]	303307	151 000	104	40 000
	30.0**	355631	25	25 x 89	338906 [†]	-	371 000	60	60 000
Ultra-Clear	6.5	344088*	50	13 x 64	346256	303392	102 000	69	45 000
	13.5	344085	50	16 x 76	330860	303307	151 000	104	40 000
	38.5	344058*	50	25 x 89	331151	-	371 000	59	60 000
Stainless Steel	38.5	301112	1	25 x 89	302133	-	165 000	135	40 000 ^{††}

Sterile and Certified-Free Tubes												
Tube Style/ Material	Vol. (mL) g-Max	Size (mm)	Beckman Standard Part Number	Certified Free Part Number	Qty	Sterile Part Number	Qty	Required Caps / Spacers (qty. 1)	Required Adapters (qty. 1)	g-Force	k Factor	Max. Speed
Ultra-Clear	38.5	25 x 89	344058	C13926	50	C14292	48	331151	-	371 000	59	60 000
Ultra-Clear	6.5	13 x 64	344088	C14280	50	C14296	48	346256	303392	102 000	69	45 000
Quick Seal Ultra-Clear	39	25 x 89	344326	C14283	50	C14299	48	342699	-	504 000	44	70 000
Polypropylene	38.5	25 x 89	326823	C14285	50	C14301	48	331151	-	371 000	59	60 000
Quick Seal Polypropylene	39	25 x 89	342414	C14288	50	C14304	48	342699	-	504 000	44	70 000

Note: To help you locate g-Max tubes in the rotor listings, these tubes are highlighted with bold, italic type.

§ To simplify ordering, this g-Max Kit includes enough spacers to fill rotor, 50 tubes and required tools.

§§ Set of 2.

† Caps are optional for these Thickwall tubes. In the Type 70 Ti, the filling level for 355642 and 355631 is 16.5 mL. For 355640 and 355630, the filling level is 7.5 mL. Maximum speeds for these open-top tubes without a cap: Polycarbonate—45 000 rpm.

Polypropylene—20 000 rpm. These speeds are those which the tubes could withstand when tested at 25°C for 24 hours. Further tests have shown that the polycarbonate tube can run at 50 000 rpm for four hours.

†† For solution densities of 2.0 g/mL and below. For solution densities above 2.0 g/mL, further speed reductions are required. Refer to publication L5-TB-072 when centrifuging stainless steel tubes.

* Sterile and C-Free options available.

** 16.5 mL with no adaptor

Rotor Replacement Parts

011757	O-ring for Rotor Handle
335585	Overspeed Disk, 70 000 rpm
337923	Rotor Lid
337924	Rotor Handle
870612	870612 O-ring for Rotor Lid

Adapters/Spacers/Caps												
303307	303392	330860	331151	337927	338906	338907	342699	343448	344635	346256	361669	302133

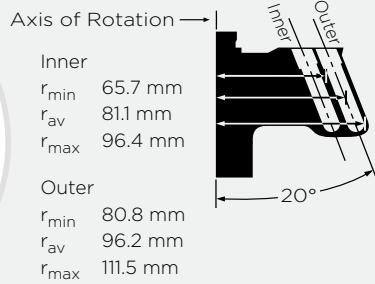

Fixed-Angle Rotor, Titanium

For use in instruments classified: H R S
 Major applications: Differential flotation of lipoproteins, multisample pelleting, or gradient separations.

Max. RPM	Max. g	k Factor	Number of Tubes Volume/Size	Rotor Capacity
50 000	270 000 (Inner) 312 000 (Outer)	39 (Inner) 33 (Outer)	44 x 6.5 mL ½ x 2½ in 13 x 64 mm	286 mL

No. 347299. Type 50.4 Ti Rotor Assembly with 3 each 870138 O-rings, 3 each 854519 O-rings, and 2 each 330336 Overspeed Disks.

No. 356957. Quick-Seal Tube Kit with 2 boxes 344619 Polypropylene Tubes, 2 boxes 344320 Ultra-Clear Tubes, 48 Spacers 344389, 1 Tube Rack 348122, 1 Spacer Removal Tool 338765, 1 Spinkote Lubricant 306812, and 1 Vacuum Grease 335148. (Cordless Tube Topper Kit required; see Tools, Accessories, and Supplies.)

No. 356956. Open-Top Tube Kit for lipoprotein flotation with 4 boxes 326820 Polypropylene Tubes, 48 Tube Caps with short stems 303113, 1 Spinkote Lubricant 306812, and 1 Vacuum Grease 335148. (301875, 305075, and 841883 Tools required.)

No. 356958. Open-Top Tube Kit with 2 boxes 326820 Polypropylene Tubes, 2 boxes 344088 Ultra-Clear Tubes, 48 Tube Caps with fill holes 346256, 1 Spinkote Lubricant 306812, and 1 Vacuum Grease 335148. (301875, 305075, and 841883 Tools required.)

No. 361659. OptiSeal Tube Kit with 4 boxes of OptiSeal Tubes 361621, 8 Spacers 361676 (4 pkg of 2), 1 OptiSeal Tube Rack 361638, 1 Tube Extraction Tool 361668, and 1 Spacer Removal Tool 338765.

Tubes and Bottles									
Tube Style/ Material	Vol. (mL) g-Max	Part No.	Quantity	Size (mm)	Required Caps/ Spacers (qty. 1)	Required Adapters (qty. 1)	g-Force	k Factor	Max. Speed
OptiSeal Polypropylene	4.7	361621	56	13 x 48	361676 ^{§§}	-	312 000	33	50 000
Quick-Seal Polypropylene	2.0	345829	50	13 x 25	345827	-	312 000	33	50 000
	2.0	357329[§]	50	13 x 25	345827	-	312 000	15	50 000
	6.0	344619	50	13 x 64	344389	-	312 000	33	50 000
Quick-Seal Ultra-Clear	6.0	344320	50	13 x 64	344389	-	312 000	33	50 000
Thinwall Polypropylene	6.5	326820	50	13 x 64	346256	-	312 000	33	50 000
Thickwall Polypropylene	4.0	355644	25	13 x 64	-	-	97 200	108	30 000
Thickwall Polycarbonate	1.0	355657	25	8 x 51	-	303823	253 000	40	45 000
	4.0	355645	25	13 x 64	-	-	312 000	33	50 000
Ultra-Clear	2.0	344091	50	8 x 49	303658	303823	252 900	40	45 000
	6.5	344088*	50	13 x 64	346256	-	312 000	33	50 000

Sterile and Certified-Free Tubes												
Tube Style/ Material	Vol. (mL) g-Max	Size (mm)	Beckman Standard Part Number	Certified Free Part Number	Qty	Sterile Part Number	Qty	Required Caps / Spacers (qty. 1)	Required Adapters (qty. 1)	g-Force	k Factor	Max. Speed
Ultra-Clear	6.5	13 x 64	344088	C14280	50	C14296	48	346256	-	312 000	33	50 000

Note: To help you locate g-Max tubes in the rotor listings, these tubes are highlighted with bold, italic type.

§ To simplify ordering, this g-Max Kit includes enough spacers to fill rotor, 50 tubes and required tools.

§§ Set of 2.

* Sterile and C-Free options available.

Rotor Replacement Parts

330336	Overspeed Disk, 50 000 rpm
337904	Break-away Handle Assembly
347298	Rotor Lid
854519	O-ring for Rotor Handle
870138	O-ring for Rotor Lid

Adapters/Spacers/Caps						
303113	303658	303823	344389	345827	346256	361676

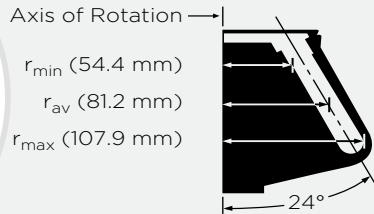

Fixed-Angle Rotor, Titanium

For use in instruments classified: H R S

Note: This rotor cannot be used in 40 000 rpm F or H instruments or the L5-50E unless the instruments have been upgraded with a diffusion pump and vacuum indicator.

Major applications: Rapid separation of plasmid DNA and rapid differential centrifugation of small particles.

Max. RPM	Max. g	k Factor	Number of Tubes Volume/Size	Rotor Capacity
50 000	302 000	69	12 x 39 mL 1 x 3 1/2 in 25 x 89 mm	468 mL

No. 337901. Type 50.2 Ti Rotor Assembly with 3 each 834301 O-rings, 3 each 854519 O-rings, and 2 each 330336 Overspeed Disks.

No. 348178. Quick-Seal Tube Kit with 2 boxes 342414 Polypropylene Tubes, 2 boxes 344326 Ultra-Clear Tubes, 12 Spacers 342699, 1 each 348124 Tube Rack, 306812 Spinkote Lubricant, and 335148 Vacuum Grease. (Cordless Tube Topper Kit required; see Tools, Accessories, and Supplies.)

No. 348177. Open-Top Tube Kit with 2 boxes 326823 Polypropylene Tubes, 2 boxes 344058 Ultra-Clear Tubes, 12 Tube Caps 331151, 1 Spinkote Lubricant 306812, and 1 Vacuum Grease 335148. (331202 and 305075 Tools required; see Tools, Accessories, and Supplies.)

No. 361662. OptiSeal Tube Kit with 4 boxes of OptiSeal Tubes 361625, 12 Spacers 361669 (6 pkg of 2), 1 OptiSeal Tube Rack 361646, 1 Tube Extraction Tool 361668, and 1 Spacer Removal Tool 338765.

Tubes and Bottles									
Tube Style/ Material	Vol. (mL) g-Max	Part No.	Quantity	Size (mm)	Required Caps/ Spacers (qty. 1)	Required Adapters (qty. 1)	g-Force	k Factor	Max. Speed
OptiSeal Polypropylene	32.4	361625	56	25 x 77	361669 ^{§§}	-	302 000	68	50 000
Quick-Seal Polypropylene	15.0	343664	50	25 x 38	343448	-	302 000	39	50 000
	15.0	357343[§]	50	25 x 38	343448	-	302 000	39	50 000
	27.0	343665	50	25 x 64	343448	-	302 000	55	50 000
	27.0	357346[§]	50	25 x 64	343448	-	302 000	55	50 000
	33.0	344623	50	25 x 79	344635	-	302 000	68	50 000
	39.0	342414*	50	25 x 89	342699	-	302 000	69	50 000
Quick-Seal Ultra-Clear	15.0	344324	50	25 x 38	343448	-	302 000	39	50 000
	27.0	344323	50	25 x 64	343448	-	302 000	55	50 000
	39.0	344326*	50	25 x 89	342699	-	302 000	69	50 000
Bottle Assembly Polycarbonate	26.3	355618	6	25 x 89	-	-	302 000	68	50 000
Thinwall Polypropylene	6.5	326820	50	13 x 64	346256	303392	194 000	61	43 000
	13.5	326814	50	16 x 76	330860	303307	179 000	85	40 000
	38.5	326823*	50	25 x 89	331151	-	302 000	69	50 000
Thickwall Polypropylene	4.0	355644	25	13 x 64	-	303392	194 000	61	43 000
	13.5	355640 [†]	25	16 x 76	338907	303307	179 000	85	40 000
	30.0**	355642 [†]	25	25 x 89	338906	-	302 000	69	50 000
	4.0	355645	25	13 x 64	-	303392	194 000	61	43 000
Thickwall Polycarbonate	13.5	355630 [†]	25	16 x 76	338907	303307	179 000	85	40 000
	30.0**	355631 [†]	25	25 x 89	338906	-	302 000	69	50 000
	4.0	355645	25	13 x 64	-	303392	194 000	61	43 000
Ultra-Clear	6.5	344088*	50	13 x 64	346256	303392	194 000	61	43 000
	13.5	344085	50	16 x 76	330860	303307	179 000	85	40 000
	38.5	344058*	50	25 x 89	331151	-	302 000	69	50 000
Stainless Steel	38.5	301112	1	25 x 89	302133	-	165 000	127	37 000 ^{††}

Sterile and Certified-Free Tubes												
Tube Style/ Material	Vol. (mL) g-Max	Size (mm)	Beckman Standard Part Number	Certified Free Part Number	Qty	Sterile Part Number	Qty	Required Caps / Spacers (qty. 1)	Required Adapters (qty. 1)	g-Force	k Factor	Max. Speed
Ultra-Clear	38.5	25 x 89	344058	C13926	50	C14292	48	331151	-	302 000	69	50 000
Ultra-Clear	6.5	13 x 64	344088	C14280	50	C14296	48	346256	303392	194 000	61	43 000
Quick Seal Ultra-Clear	39	25 x 89	344326	C14283	50	C14299	48	342699	-	302 000	69	50 000
Polypropylene	38.5	25 x 89	326823	C14285	50	C14301	48	331151	-	302 000	69	50 000
Quick Seal Polypropylene	39	25 x 89	342414	C14288	50	C14304	48	342699	-	302 000	69	50 000

Note: To help you locate g-Max tubes in the rotor listings, these tubes are highlighted with bold, italic type.
[§] To simplify ordering, this g-Max Kit includes enough spacers to fill rotor, 50 tubes and required tools.
^{§§} Set of 2.
[†] Caps are optional for these thickwall tubes. In the Type 50.2 Ti, the filling level for P/N 355642 and P/N 355631 is 16.5 mL. For P/N 355640 and P/N 355630, the filling level is 8 mL. Maximum speeds for these open-top tubes without a cap: Polycarbonate – 45 000

rpm; Polypropylene – 20 000 rpm. These speeds are those which the tubes could withstand when tested at 25°C for 24 hours. Further tests have shown that the polycarbonate tubes can run at 50 000 rpm for four hours.
^{† †} Refer to the section on RUN SPEEDS in the Type 50.2 Rotor manual before using.
^{*} Sterile and C-Free options available.
^{**} 16.5 mL with no adaptor

Rotor Replacement Parts

330336	Overspeed Disk, 50 000 rpm
337903	Rotor Lid
337904	Break-away Handle Assembly
834301	Large O-ring for Rotor Lid
854519	Small O-ring for Rotor Lid

Adapters/Spacers/Caps											
303307	303392	330860	331151	338906	338907	342699	343448	344635	346256	361669	302133

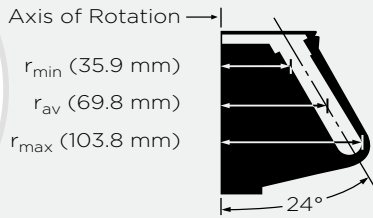

Fixed-Angle Rotor, Titanium

For use in instruments classified: H R S

Note: This rotor cannot be used in 40 000 rpm F or H instruments or the L5-50E unless the instruments have been upgraded with a diffusion pump and vacuum indicator.

Major applications: Differential centrifugation of large volumes of subcellular fractions and viruses.

Max. RPM	Max. g	k Factor	Number of Tubes Volume/Size	Rotor Capacity
45 000	235 000	133	6 x 94 mL 1½ x 4 in 38 x 102 mm	564 mL

No. 339160. Type 45 Ti Rotor Assembly with 3 each 854519 O-rings, 3 each 878260 O-rings, and 2 each 335458 Overspeed Disks.

No. 348175. Quick-Seal Tube Kit with 4 boxes 345776 Polypropylene Tubes, 4 boxes 345778 Ultra-Clear Tubes, 8 Spacers 342697, 1 each 348125 Tube Rack, 306812 Spinkote Lubricant, and 335148 Vacuum Grease. (Cordless Tube Topper Kit required; see Tools, Accessories, and Supplies.)

No. 348176. Open-Top Tube Kit with 4 boxes 345775 Polypropylene Tubes, 4 boxes 345777 Ultra-Clear Tubes, 8 Tube Caps 330901, 1 Spinkote Lubricant 306812, and 1 Vacuum Grease 335148. (331202 and 305075 Tools required; see Tools, Accessories, and Supplies.)

Tubes and Bottles									
Tube Style/ Material	Vol. (mL) g-Max	Part No.	Quantity	Size (mm)	Required Caps/ Spacers (qty. 1)	Required Adapters (qty. 1)	g-Force	k Factor	Max. Speed
Quick-Seal Polypropylene	94.0	345776*	25	38 x 102	342697	-	235 000	133	45 000
Quick-Seal Ultra-Clear	94.0	345778	25	38 x 102	342697	-	235 000	133	45 000
Polycarbonate Bottle Assembly	70.0	355655 ^{ΔΔ}	6	38 x 102	355623	-	235 000	133	45 000 ⁺
	70.0	355622 ^{ΔΔΔ}	6	38 x 102	-	-	235 000	133	45 000 ⁺
Thinwall Polypropylene	6.5	326820	50	13 x 64	346256	303449	138 000	90	39 000
	10.5	326822	50	13 x 89	346256	303459	156 000	110	39 000
	13.5	326814	50	16 x 76	330860	303448	149 000	107	39 000
Thickwall Polypropylene	4.0	355644	25	13 x 64	-	303449	138 000	90	39 000
	13.5	355640	25	16 x 76	338907 ⁺	303448	149 000	107	39 000
	10.5	355639	25	13 x 89	-	303459	156 000	110	39 000
	81.0	355643	25	38 x 102	338905 ⁺	-	235 000	133	45 000
	47.0	355643 (No Cap)	25	38 x 102	-	-	26 200	1195	15 000
Thickwall Polycarbonate	4.0	355645	25	13 x 64	-	303449	138 000	90	39 000
	13.5	355630	25	16 x 76	338907 ⁺	303448	149 000	107	39 000
	10.5	355629	25	13 x 89	-	303459	156 000	110	39 000
	81.0	355628	25	38 x 102	338905 ⁺	-	235 000	133	45 000
	45.0	355628 (No Cap)	25	38 x 102	-	-	26 200	1195	15 000
Ultra-Clear	6.5	344088*	50	13 x 64	346256	303449	138 000	90	39 000
	10.5	344087	50	13 x 89	346256	303459	156 000	110	39 000
	13.5	344085	50	16 x 76	330860	303448	149 000	107	39 000
	94.0	345777	25	38 x 102	330901	-	235 000	133	45 000

Sterile and Certified-Free Tubes												
Tube Style/ Material	Vol. (mL) g-Max	Size (mm)	Beckman Standard Part Number	Certified Free Part Number	Qty	Sterile Part Number	Qty	Required Caps / Spacers (qty. 1)	Required Adapters (qty. 1)	g-Force	k Factor	Max. Speed
Ultra-Clear	6.5	13 x 64	344088	C14280	50	C14296	48	346256	303449	138 000	90	39 000
Polypropylene	100	38 x 102	345776	C14289	25	C14305	24	342697	-	235 000	133	45 000

\$\$\$ Bottle assembly. Reduce speed to 35 000 rpm when the bottle is centrifuged less than full (minimum fill volume is 35 mL).

ΔΔ Bottle only. Reduce speed to 35 000 rpm when the bottle is centrifuged less than full (minimum fill volume is 35 mL).

+ Caps are optional for these Thickwall tubes. In the Type 45 Ti the filling level for 355643 and 355628 is 47 mL. For 355640 and 355630, the filling level is 8 mL. Maximum speeds for these open-top tubes without a cap: Polycarbonate — 30 000 rpm; Polypropylene — 15 000 rpm.

* Sterile and C-Free options available.

Rotor Replacement Parts

335458	Overspeed Disk, 45 000 rpm
339163	Rotor Lid
339164	Rotor Handle
854519	O-ring, small, for Rotor Lid
878260	O-ring, large, for Rotor Lid

Adapters/Spacers/Caps								
303448	303449	303459	330860	330901	338905	338907	342697	346256

TYPE 42.2 Ti **BIOE** 72 x 230 μ L

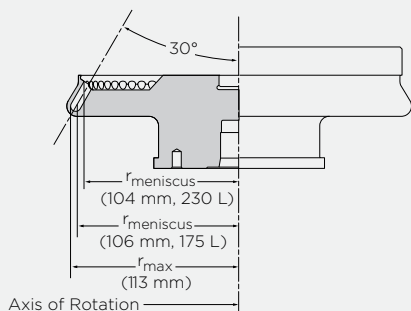

Fixed-Angle Rotor, Titanium

For use in instruments classified: H R S

Major applications: Differential flotation of lipoproteins, rapid separation of viruses and microsomes.

Max. RPM	Max. <i>g</i>	<i>k</i> Factor	Number of Tubes Volume/Size	Rotor Capacity
42 000	223 000	12	72 x 230 μ L 0.29 x 0.8 in 7 x 20 mm	16.5 mL

No. 343007. Type 42.2 Rotor Package. Includes Rotor, 1 box 342303 Cellulose Propionate Tubes, 3 each 885028 O-rings, 2 each 330329 Overspeed Disks, 1 Vise Assembly 332688, 1 Rotor Handle 343008, 1 Forceps 878446, 1 Spinkote Lubricant 306812, and 1 Vacuum Grease 335148.

Tubes and Bottles								
Tube Style/ Material	Volume (μ L)	Part No.	Quantity	Size (mm)	Caps/ Spacers (qty. 1)	<i>g</i> -Force	<i>k</i> Factor	Max. Speed
Cellulose Propionate	230	342303	100	7 x 20	-	223 000	12	42 000
Thickwall Polypropylene	230	343621	100	7 x 20	-	223 000	12	42 000
Thickwall Polycarbonate	230	343775	100	7 x 20	-	223 000	12	42 000

Note: Originally this rotor was intended for small-sample lipoprotein applications and was called the LP 42 Ti. However, it has become a popular choice for processing a variety of microsamples, and the name has been changed to the Type 42.2 Ti to reflect its more general use.

Rotor Replacement Parts

330329	Overspeed Disk, 42 000 rpm
332688	Vise Assembly
343008	Rotor Handle
878446	Forceps
885028	O-ring for Rotor Lid

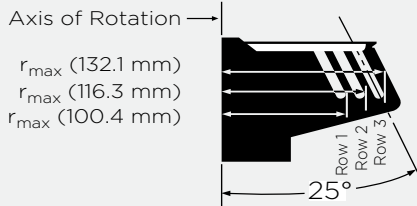

Fixed-Angle Rotor, Aluminum

For use in instruments classified: H R S

Major applications: Differential flotation of many small samples of lipoproteins.

Max. RPM	Max. <i>g</i>	<i>k</i> Factor	Number of Tubes Volume/Size	Rotor Capacity
25 000	70 300 81 400 92 500	84 71 62	100 x 1 mL ⁵ / ₁₆ x 2 in 8 x 51 mm	100 mL

No. 347261. Type 25 Rotor Assembly with 3 each 011757 O-rings, 3 each 878272 O-rings, 2 each 330333 Overspeed Disks.

No. 348184. Quick-Seal Tube Kit with 4 boxes 345831 Quick-Seal Polypropylene Tubes, 50 Spacers 345824, 1 Tube Rack 349661, 1 Spinkote Lubricant 306812, and 1 Vacuum Grease 335148. (Cordless Tube Topper Kit required; see Tools, Accessories, and Supplies.)

No. 348635. Open-Top Tube Kit with 5 boxes 355657 Thickwall Polycarbonate Tubes, 1 Spinkote Lubricant 306812, and 1 Vacuum Grease 335148.

Tubes and Bottles									
Tube Style/ Material	Vol. (mL)	Part No.	Quantity	Size (mm)	Required Caps/ Spacers (qty. 1)	Required Adapters (qty. 1)	<i>g</i> -Force	<i>k</i> Factor	Max. Speed
Thickwall Polycarbonate	1.0	355657	25	8 x 51	-	-	92 500	62	25 000
Quick-Seal Polypropylene	1.0	345831	50	8 x 51	345824	-	92 500	62	25 000

Note: Dimensions and forces for the three rows of tubes in the Type 25 rotor are as follows:

	Row 1	Row 2	Row 3
<i>r</i> _{min} (mm)	81.7	97.5	113.4
force (<i>g</i>)	57 200	68 300	79 400
<i>r</i> _{av} (mm)	91.1	106.9	122.8
force (<i>g</i>)	63 800	74 800	86 000
<i>r</i> _{max} (mm)	100.4	116.3	132.1
force (<i>g</i>)	70 300	81 400	92 500

Rotor Replacement Parts

011757	O-ring for Rotor Handle
330333	Overspeed Disk, 25 000 rpm
335453	Overspeed Disk, 23 000 rpm
347266	Rotor Lid
347267	Rotor Handle
878272	O-ring for Rotor Body

Spacers

345824



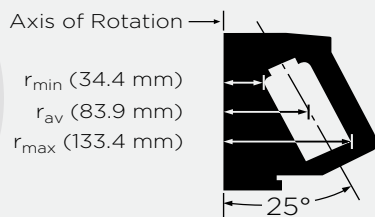

Fixed-Angle Rotor, Aluminum

For use in instruments classified: H R S

Major applications: Differential centrifugation of large volumes of viruses and large subcellular particles.

Max. RPM	Max. <i>g</i>	<i>k</i> Factor	Number of Tubes Volume/Size	Rotor Capacity
19 000	53 900	951	6 x 250 mL 2 3/8 x 4 3/4 in 60 x 121 mm	1500 mL

No. 325620. Type 19 Rotor Assembly with 3 each 325623 Gaskets, 3 each 801773 O-rings, and 2 each 330331 Overspeed Disks.

No. 325632. Type 19 Rotor Package. Includes Rotor, 6 each 334205 250 mL Bottle and Cap Assemblies, 1 each 355627 (pkg of 6) 250mL Bottle, 306812 Spinkote Lubricant, and 335148 Vacuum Grease.

Bottles									
Tube Style/ Material	Volume (μL)	Part No.	Quantity	Size (mm)	Caps/ Spacers (qty. 1)	Required Adapters (qty. 1)	<i>g</i> -Force	<i>k</i> Factor	Max. Speed
Polypropylene Bottle Only	250.0	355627	6	60 x 121	-	-	53 900	951	19 000
Polypropylene Bottle Assembly	250.0	334205	1	60 x 121	-	-	53 900	951	19 000

Rotor Replacement Parts

325623	Gasket for Rotor Handle
325624	Rotor Handle
330331	Overspeed Disk, 19 000 rpm
332826	Rotor Lid
335353	Bottle Extractor
801773	O-ring for Rotor Body

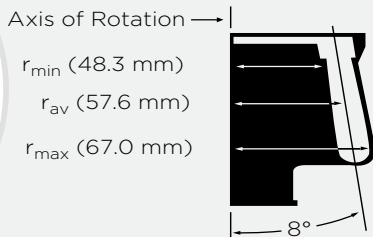

NVT Near-Vertical Tube Rotor, Titanium

For use in instruments classified: R S

Note: Non-precipitating solutions up to 1.7 g/mL in density can be run in this rotor without a reduction in rotor speed. For speed reductions for CsCl prescription, refer to rotor manual.

Major applications: Separation of plasmid or mitochondrial DNA in CsCl gradients in 2.5 - 4 h..

Max. RPM	Max. <i>g</i>	<i>k</i> Factor	Number of Tubes Volume/Size	Rotor Capacity
100 000	750 000	8	8 x 5.1 mL ½ x 2 in 13 x 51 mm	40.8 mL

No. 365898. NVT 100 Rotor Package with 12 each 342882 Rotor Plug Gaskets, 1 each 342705 Vise Assembly, 367084 Vise Adapter Assembly, 858121 Torque Wrench, 976959 Torx Wrench Adapter, 306812 Spinkote Lubricant, and 2 each 363304 Overspeed Disks.

No. 360979. Quick-Seal Tube Kit with 4 boxes 342412 Quick-Seal Polypropylene Tubes, 8 Spacers 342883, 1 Tube Rack 348122, and 1 Tube Extraction Tool 361668 (Cordless Tube Topper Kit required, see Tools, Accessories, and Supplies).

Tubes and Bottles									
Tube Style/ Material	Vol. (mL) <i>g</i> -Max	Part No.	Quantity	Size (mm)	Spacers (qty. 1)	Required Caps / Spacers (qty. 1)	<i>g</i> -Force	<i>k</i> Factor	Max. Speed
Quick-Seal Polypropylene	2.0	345829	50	13 x 25	342883	345827	750 000	8	100 000
	5.1	342412	50	13 x 51	342883	345827	750 000	8	100 000

Note: To help you locate *g*-Max tubes in the rotor listings, these tubes are highlighted with bold, italic type.

§ To simplify ordering, this *g*-Max Kit includes enough spacers to fill rotor, 50 tubes and required tools.

Rotor Replacement Parts

342882	Gasket for Rotor Plug
363304	Overspeed Disk, 100 000 rpm
368545	Rotor Replacement Plug (single)
368546	Rotor Replacement Plugs with Gaskets (set of 8)
858121	Torque Wrench
976959	Torx Wrench Adapter

Adapters/Spacers	
342883	345827

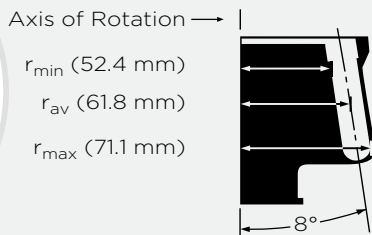

NVT Near-Vertical Tube Rotor, Titanium

For use in instruments classified: H R S

Note: Non-precipitating solutions up to 1.7 g/mL in density can be run in this rotor without a reduction in rotor speed. For speed reductions for CsCl prescription, refer to rotor manual.

Major applications: Separation of plasmid or mitochondrial DNA in CsCl gradients in 2.5 - 4 h.

Max. RPM	Max. g	k Factor	Number of Tubes Volume/Size	Rotor Capacity
90 000	645 000	10	8 x 5.1 mL ½ x 2 in 13 x 51 mm	40.8 mL

No. 362752. NVT 90 Rotor Package with 12 each 342882 Rotor Plug Gaskets, 1 each 342705 Vise Assembly, 858121 Torque Wrench, 976959 Torx Wrench Adapter, 306812 Spinkote Lubricant, and 2 each 355539 Overspeed Disks.

No. 360970. OptiSeal Tube Kit with 4 boxes 362185 OptiSeal Polypropylene Tubes, 8 Spacers 362198, 1 Tube Rack 361638, 1 Tube Extraction Tool 361668, and 1 Spacer Removal Tool 338765.

No. 360979. Quick-Seal Tube Kit with 4 boxes 342412 Quick-Seal Polypropylene Tubes, 8 Spacers 342883, 1 Tube Rack 348122, and 1 Tube Extraction Tool 361668 (Cordless Tube Topper Kit required, see Tools, Accessories, and Supplies).

Tubes and Bottles									
Tube Style/ Material	Vol. (mL) <i>g-Max</i>	Part No.	Quantity	Size (mm)	Spacers (qty. 1)	Required Caps / Spacers (qty. 1)	<i>g-Force</i>	<i>k Factor</i>	Max. Speed
OptiSeal Polypropylene	4.9	362185	56	13 x 51	362198	-	645 000	10	90 000
Quick-Seal Polypropylene	2.0	345829	50	13 x 25	342883	345827	645 000	4	90 000
	5.1	342412	50	13 x 51	342883	-	645 000	10	90 000
Quick-Seal Ultra-Clear	5.1	344075	50	13 x 51	342883	-	645 000	10	90 000

Note: To help you locate *g-Max* tubes in the rotor listings, these tubes are highlighted with bold, italic type.

§ To simplify ordering, this *g-Max* Kit includes enough spacers to fill rotor, 50 tubes, and required tools.

Rotor Replacement Parts

342882	Gasket for Rotor Plug
355539	Overspeed Disk, 90 000 rpm
368545	Rotor Replacement Plug (single)
368546	Rotor Replacement Plugs with Gaskets (set of 8)
858121	Torque Wrench
976959	Torx Wrench Adapter
342705	Rotor Vise Assembly

Adapters/Spacers/Caps

342883 | 345827 | 362198



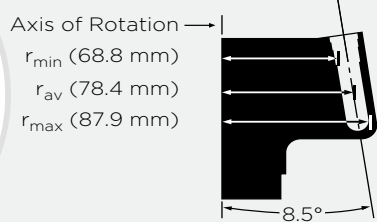

NVT Near-Vertical Tube Rotor, Titanium

For use in instruments classified: H R S

Note: Solutions up to 1.7 g/mL in density can be run in this rotor without a reduction in rotor speed.

Major applications: Separation of plasmid, mitochondrial, or chromosomal DNA, proteoglycans, and lipoproteins.

Max. RPM	Max. <i>g</i>	<i>k</i> Factor	Number of Tubes Volume/Size	Rotor Capacity
65 000	416 000	15	16 x 5.1 mL ½ x 2 in 13 x 51 mm	81.6 mL

No. 361073. NVT 65.2 Rotor Package with 12 each 342882 Rotor Plug Gaskets, 1 each 342705 Vise Assembly, 858121 Torque Wrench, 976959 Torx Wrench Adapter, 306812 Spinkote Lubricant, and 2 each 330338 Overspeed Disks.

No. 360972. OptiSeal Tube Kit with 4 boxes 362185 OptiSeal Polypropylene Tubes, 16 Spacers 362198, 1 Tube Rack 361638, 1 Tube Extraction Tool 361668, and 1 Spacer Removal Tool 338765.

No. 360977. Quick-Seal Tube Kit with 4 boxes 342412 Quick-Seal Polypropylene Tubes, 16 Spacers 342883, 1 Tube Rack 348122, and 1 Tube Extraction Tool 361668 (Cordless Tube Topper Kit required, see Tools, Accessories, and Supplies).

Tubes and Bottles									
Tube Style/ Material	Vol. (mL) <i>g-Max</i>	Part No.	Quantity	Size (mm)	Spacers (qty. 1)	Required Caps / Spacers (qty. 1)	<i>g</i> -Force	<i>k</i> Factor	Max. Speed
OptiSeal Polypropylene	4.9	362185	56	13 x 51	362198	-	416 000	15	65 000
Quick-Seal Polypropylene	2.0 5.1	345829 342412	50 50	13 x 25 13 x 51	342883 342883	345827 -	416 000 416 000	7 15	65 000 65 000
Quick-Seal Ultra-Clear	5.1	344075	50	13 x 51	342883	-	416 000	15	65 000

Note: To help you locate *g*-Max tubes in the rotor listings, these tubes are highlighted with bold, italic type.

Rotor Replacement Parts	
330338	Overspeed Disk, 65 000 rpm
342882	Gasket for Rotor Plug
368545	Rotor Replacement Plug (single)
368546	Rotor Replacement Plugs with Gaskets (set of 8)
858121	Torque Wrench
976959	Torx Wrench Adapter

Adapters/Spacers		
342883	345827	362198

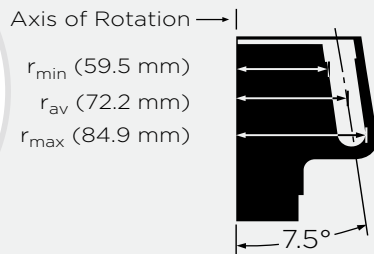

NVT Near-Vertical Tube Rotor, Titanium

For use in instruments classified: H R S

Note: Non-precipitating solutions up to 1.7 g/mL in density can be run in this rotor without a reduction in rotor speed.

Major applications: Separation of plasmid or mitochondrial DNA in CsCl gradients.

Max. RPM	Max. <i>g</i>	<i>k</i> Factor	Number of Tubes Volume/Size	Rotor Capacity
65 000	402 000	21	8 x 13.5 mL 5/8 x 3 in 16 x 76 mm	108 mL

No. 362755. NVT 65 Rotor Package with 12 each 349290 Rotor Plug Gaskets, 1 each 342705 Vise Assembly, 858121 Torque Wrench, 976959 Torx Wrench Adapter, 306812 Spinkote Lubricant, and 2 each 330338 Overspeed Disks.

No. 360973. OptiSeal Tube Kit with 4 boxes 362181 OptiSeal Polypropylene Tubes, 8 Spacers 362202, 1 Tube Rack 360538, 1 Tube Extraction Tool 361668, and 1 Spacer Removal Tool 338765.

No. 360976. Quick-Seal Tube Kit with 4 boxes 342413 Quick-Seal Polypropylene Tubes, 8 Spacers 349289, 1 Tube Rack 348123, and 1 Tube Extraction Tool 361668 (Cordless Tube Topper Kit required, see Tools, Accessories, and Supplies).

Tubes and Bottles									
Tube Style/ Material	Vol. (mL) <i>g-Max</i>	Part No.	Quantity	Size (mm)	Spacers (qty. 1)	Required Caps / Spacers (qty. 1)	<i>g</i> -Force	<i>k</i> Factor	Max. Speed
OptiSeal Polypropylene	11.2	362181	56	16 x 70	362202	-	402 000	17	65 000
Quick-Seal Polypropylene	6.3	345830	50	16 x 44	349289	349900	402 000	8	65 000
	6.3	357335[§]	50	16 x 45	349289	349900	402 000	8	65 000
	8.0	344621	50	16 x 58	349289	356571	402 000	11	65 000
	8.0	357337[§]	50	16 x 58	349289	356571	402 000	11	65 000
	10.0	344622	50	16 x 67	349289	349901	402 000	15	65 000
	13.5	342413*	50	16 x 76	349289	-	402 000	21	65 000
Quick-Seal Ultra-Clear	13.5	344322	50	16 x 76	349289	-	402 000	21	65 000

Sterile and Certified-Free Tubes												
Tube Style/ Material	Vol. (mL) <i>g-Max</i>	Size (mm)	Beckman Standard Part Number	Certified Free Part Number	Qty	Sterile Part Number	Qty	Required Caps / Spacers (qty. 1)	Required Adapters (qty. 1)	<i>g</i> -Force	<i>k</i> Factor	Max. Speed
Quick Seal Polypropylene	13.5	16 x 76	342413	C14290	50	C14306	48	349289	-	402 000	21	65 000

Note: To help you locate *g-Max* tubes in the rotor listings, these tubes are highlighted with bold, italic type.

§ To simplify ordering, this *g-Max* Kit includes enough spacers to fill rotor, 50 tubes, and required tools.

* Sterile and C-Free options available.

Rotor Replacement Parts

330338	Overspeed Disk, 65 000 rpm
349290	Gasket for Rotor Plug
368545	Rotor Replacement Plug (single)
392084	Rotor Replacement Plugs with Gaskets (set of 8)
858121	Torque Wrench
976959	Torx Wrench Adapter
342705	Rotor Vise Assembly

Adapters/Spacers/Caps

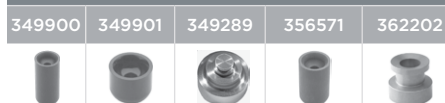

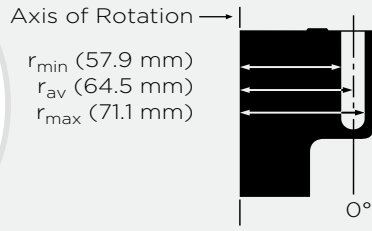

Vertical-Tube Rotor, Titanium

For use in instruments classified: H R S

Note: Solutions up to 1.7 g/mL in density can be run in this rotor without reduction in rotor speed.

Major applications: High-speed density gradient separations.

Max. RPM	Max. g	k Factor	Number of Tubes Volume/Size	Rotor Capacity
90 000	645 000	6	8 x 5.1 mL ½ x 2 in 13 x 51 mm	40.8 mL

No. 362751. VTI 90 Rotor Package with 12 each 342882 Rotor Plug Gaskets, 1 each 342705 Vise Assembly, 858121 Torque Wrench, 976959 Torx Wrench Adapter, 306812 Spinkote Lubricant, and 2 each 355539 Overspeed Disks.

No. 360970. OptiSeal Tube Kit with 4 boxes 362185 OptiSeal Polypropylene Tubes, 8 Spacers 362198, 1 Tube Rack 361638, 1 Tube Extraction Tool 361668, and 1 Spacer Removal Tool 338765.

No. 360979. Quick-Seal Tube Kit with 4 boxes 342412 Quick-Seal Polypropylene Tubes, 8 Spacers 342883, 1 Tube Rack 348122, and 1 Tube Extraction Tool 361668 (Cordless Tube Topper Kit required, see Tools, Accessories, and Supplies).

Tubes and Bottles									
Tube Style/ Material	Vol. (mL) <i>g-Max</i>	Part No.	Quantity	Size (mm)	Spacers (qty. 1)	Required Caps / Spacers (qty. 1)	<i>g-Force</i>	<i>k Factor</i>	Max. Speed
OptiSeal Polypropylene	4.9	362185	56	13 x 51	362198	-	645 000	6	90 000
Quick-Seal Polypropylene	2.0	357325[§]	50	13 x 25	342883	345827	645 000	6	90 000
	2.0	345829	50	13 x 25	342883	345827	645 000	6	90 000
	5.1	342412	50	13 x 51	342883	-	645 000	6	90 000
	3.5	349621	50	13 x 31.5	342883	356886	645 000	6	90 000
Quick-Seal Ultra-Clear	5.1	344075	50	13 x 51	342883	-	645 000	10	90 000

Note: To help you locate *g-Max* tubes in the rotor listings, these tubes are highlighted with bold, italic type.

§ To simplify ordering, this *g-Max* Kit includes enough spacers to fill rotor, 50 tubes and required tools.

Rotor Replacement Parts

342882	Gasket for Rotor Plug
355539	Overspeed Disk, 90 000 rpm
368545	Rotor Replacement Plug (single)
368546	Rotor Replacement Plugs with Gaskets (set of 8)
858121	Torque Wrench
976959	Torx Wrench Adapter
349290	Plug Gasket

Adapters/Spacers

342883 345827 362198



VTi 65.2 BIOE 16 x 5.1 mL

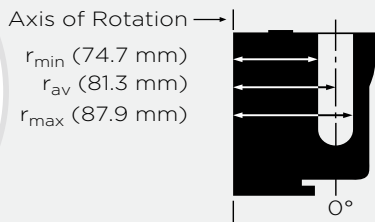

Vertical-Tube Rotor, Titanium

For use in instruments classified: H R S

Note: Solutions up to 1.7 g/mL in density can be run in this rotor without reduction in rotor speed.

Major applications: Isopycnic and rate-zonal centrifugation of small particles.

Max. RPM	Max. g	k Factor	Number of Tubes Volume/Size	Rotor Capacity
65 000	416 000	10	16 x 5.1 mL ½ x 2 in 13 x 51 mm	81.6 mL

No. 362754. VTi 65.2 Rotor Package with 12 each 342882 Rotor Plug Gaskets, 1 each 342705 Vise Assembly, 858121 Torque Wrench, 976959 Torx Wrench Adapter, 306812 Spinkote Lubricant, and 2 each 330338 Overspeed Disks.

No. 360972. OptiSeal Tube Kit with 4 boxes 362185 OptiSeal Polypropylene Tubes, 16 Spacers 362198, 1 Tube Rack 361638, 1 Tube Extraction Tool 361668, and 1 Spacer Removal Tool 338765.

No. 360977. Quick-Seal Tube Kit with 4 boxes 342412 Quick-Seal Polypropylene Tubes, 16 Spacers 342883, 1 Tube Rack 348122, and 1 Tube Extraction Tool 361668 (Cordless Tube Topper Kit required, see Tools, Accessories, and Supplies).

Tubes and Bottles									
Tube Style/ Material	Vol. (mL) <i>g-Max</i>	Part No.	Quantity	Size (mm)	Spacers (qty. 1)	Required Caps / Spacers (qty. 1)	<i>g-Force</i>	<i>k Factor</i>	Max. Speed
OptiSeal Polypropylene	4.9	362185	56	13 x 51	362198	-	416 000	10	65 000
Quick-Seal Polypropylene	2.0	357326[§]	50	13 x 25	342883	345827	416 000	10	65 000
	2.0	345829	50	13 x 25	342883	345827	416 000	10	65 000
	5.1	342412	50	13 x 51	342883	-	416 000	10	65 000
Quick-Seal Ultra-Clear	5.1	344075	50	13 x 51	342883	-	416 000	10	65 000

Note: To help you locate *g-Max* tubes in the rotor listings, these tubes are highlighted with bold, italic type.

§ To simplify ordering, this *g-Max* Kit includes enough spacers to fill rotor, 50 tubes, and required tools.

Rotor Replacement Parts

330338	Overspeed Disk, 65 000 rpm
342882	Gasket for Rotor Plug
368545	Rotor Replacement Plug (single)
368546	Rotor Replacement Plugs with Gaskets (set of 8)
858121	Torque Wrench
976959	Torx Wrench Adapter

Adapters/Spacers

342883 345827 362198



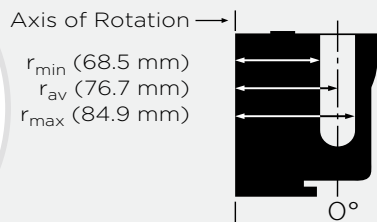

Vertical-Tube Rotor, Titanium

For use in instruments classified: H R S

Note: Solutions up to 1.7 g/mL in density can be run in this rotor without reduction in rotor speed.

Major applications: Isopycnic and rate-zonal centrifugation of small particles.

Max. RPM	Max. g	k Factor	Number of Tubes Volume/Size	Rotor Capacity
65 000	402 000	13	8 x 13.5 mL 5/8 x 3 in 16 x 76 mm	108 mL

No. 362759. VTI 65.1 Rotor Package with 12 each 349290 Rotor Plug Gaskets, 1 each 342705 Vise Assembly, 858121 Torque Wrench, 976959 Torque Wrench, 306812 Spinkote Lubricant, and 2 each 330338 Overspeed Disks.

No. 360973. OptiSeal Tube Kit with 4 boxes 362181 OptiSeal Polypropylene Tubes, 8 Spacers 362202, 1 Tube Rack 360538, 1 Tube Extraction Tool 361668, and 1 Spacer Removal Tool 338765.

No. 360976. Quick-Seal Tube Kit with 4 boxes 342413 Quick-Seal Polypropylene Tubes, 8 Spacers 349289, 1 Tube Rack 348123, and 1 Tube Extraction Tool 361668 (Cordless Tube Topper Kit required, see Tools, Accessories, and Supplies).

Tubes and Bottles									
Tube Style/ Material	Vol. (mL) <i>g-Max</i>	Part No.	Quantity	Size (mm)	Spacers (qty. 1)	Required Caps / Spacers (qty. 1)	<i>g-Force</i>	<i>k Factor</i>	Max. Speed
OptiSeal Polypropylene	11.2	362181	56	16 x 70	362202	-	402 000	13	65 000
Quick-Seal Polypropylene	6.3	357335[§]	50	16 x 45	349289	349900	402 000	13	65 000
	6.3	345830	50	16 x 44	349289	349900	402 000	13	65 000
	8.0	344621	50	16 x 58	349289	356571	402 000	13	65 000
	8.0	357337[§]	50	16 x 58	349289	356571	402 000	13	65 000
	10.0	344622	50	16 x 67	349289	349901	402 000	13	65 000
Quick-Seal Ultra-Clear	13.5	342413*	50	16 x 76	349289	-	402 000	13	65 000
	13.5	344322	50	16 x 76	349289	-	402 000	13	65 000

Sterile and Certified-Free Tubes												
Tube Style/ Material	Vol. (mL) <i>g-Max</i>	Size (mm)	Beckman Standard Part Number	Certified Free Part Number	Qty	Sterile Part Number	Qty	Required Caps / Spacers (qty. 1)	Required Adapters (qty. 1)	<i>g-Force</i>	<i>k Factor</i>	Max. Speed
Quick Seal Polypropylene	13.5	16 x 76	342413	C14290	50	C14306	48	349289	-	402 000	13	65 000

Note: To help you locate *g-Max* tubes in the rotor listings, these tubes are highlighted with bold, italic type.

§ To simplify ordering, this *g-Max* Kit includes enough spacers to fill rotor, 50 tubes and required tools.

* Sterile and C-Free options available.

Rotor Replacement Parts

330338	Overspeed Disk, 65 000 rpm
349290	Gasket for Rotor Plug
392083	Rotor Replacement Plug (single)
392084	Rotor Plugs with Gaskets, Torx (set of 8)
858121	Torque Wrench
976959	Wrench Adapter for Torx Plug
342705	Rotor Vise Assembly

Adapters/Spacers



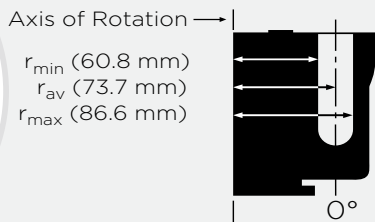
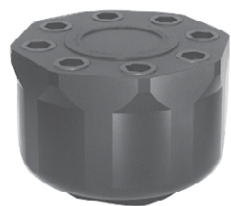

Vertical-Tube Rotor, Titanium

For use in instruments classified: H R S

Note: Solutions up to 1.7 g/mL in density can be run in this rotor without reduction in rotor speed.

Major applications: Isopycnic and rate-zonal centrifugation.

Max. RPM	Max. g	k Factor	Number of Tubes Volume/Size	Rotor Capacity
50 000	242 000	36	8 x 39 mL 1 x 3½ in 25 x 89 mm	312 mL

No. 362758. VTI 50 Rotor Package with 12 each 340825 Rotor Plug Gaskets, 1 each 332688 Vise Assembly, 369791 Torque Wrench, 355588 Hex Plug Adapter, 306812 Spinkote Lubricant, and 2 each 330336 Overspeed Disks.

No. 360974. OptiSeal Tube Kit with 4 boxes 362183 OptiSeal Polypropylene Tubes, 10 Spacers 362204, 1 Tube Rack 360542, and 1 Tube Extraction Tool 361668.

No. 360975. Quick-Seal Tube Kit with 4 boxes 342414 Quick-Seal Polypropylene Tubes, 10 Spacers 342417, 1 Tube Rack 348124, and 1 Tube Extraction Tool 361668 (Cordless Tube Topper Kit required, see Tools, Accessories, and Supplies).

Tubes and Bottles									
Tube Style/ Material	Vol. (mL) <i>g-Max</i>	Part No.	Quantity	Size (mm)	Spacers (qty. 1)	Required Caps / Spacers (qty. 1)	<i>g-Force</i>	<i>k Factor</i>	Max. Speed
OptiSeal Polypropylene	36.2	362183	56	25 x 89	362204	-	242 000	36	50 000
Quick-Seal Polypropylene	15.0	357344[§]	50	25 x 38	342417	343448	242 000	36	50 000
	15.0	343664	50	25 x 38	342417	343448 [∅]	242 000	28	50 000
	27.0	343665	50	25 x 64	342417	343448	242 000	36	50 000
	39.0	342414*	50	25 x 89	342417	-	242 000	36	50 000
Quick-Seal Ultra-Clear	15.0	344324	50	25 x 35	342417	343448 [∅]	242 000	28	50 000
	27.0	344323	50	25 x 64	342417	343448	242 000	36	50 000
	39.0	344326*	50	25 x 89	342417	-	242 000	36	50 000

Sterile and Certified-Free Tubes												
Tube Style/ Material	Vol. (mL) <i>g-Max</i>	Size (mm)	Beckman Standard Part Number	Certified Free Part Number	Qty	Sterile Part Number	Qty	Required Caps / Spacers (qty. 1)	Required Adapters (qty. 1)	<i>g-Force</i>	<i>k Factor</i>	Max. Speed
Quick Seal Ultra-Clear	39	25 x 89	344326	C14283	50	C14299	48	342417	-	242 000	36	50 000
Quick Seal Polypropylene	39	25 x 89	342414	C14288	50	C14304	48	342417	-	242 000	36	50 000

Note: To help you locate *g-Max* tubes in the rotor listings, these tubes are highlighted with bold, italic type.

§ To simplify ordering, this *g-Max* Kit includes enough spacers to fill rotor, 50 tubes, and required tools.

∅ Two required.

* Sterile and C-Free options available.

Rotor Replacement Parts

330336	Overspeed Disk, 50 000 rpm
340825	Gasket for Rotor Plug
355587	Rotor Plug, Hex Style (If replacing all rotor plugs, use Hex Style)
355588	Hex Plug-wrench Adapter
369791	Torque Wrench

Adapters/Spacers		
342417	343448	362204

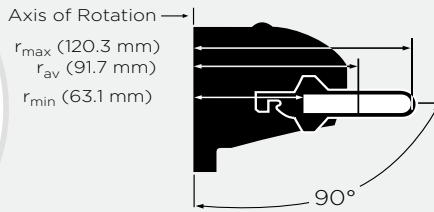

Swinging-Bucket Rotor, Titanium Head, and Buckets

For use in instruments classified: H R S
Major applications: Rate-zonal centrifugation of proteins and RNA, differential centrifugation of subcellular fractions.

Max. RPM	Max. g	k Factor	Number of Tubes Volume/Size	Rotor Capacity
60 000	485 000	45	6 x 4 mL 7/16 x 2 3/8 in 11 x 60 mm	24 mL

No. 335650. SW 60 Ti Rotor Package. Includes Rotor, 2 boxes 328874 Polypropylene Tubes, 2 boxes 344062 Ultra-Clear Tubes, 1 each 331313 Bucket Holder Rack, 306812 Spinkote Lubricant, 335148 Vacuum Grease, 331155 Overspeed Disk, and 24 each 868638 O-rings.

No. 335649. SW 60 Ti Rotor Assembly.

Tubes and Bottles									
Tube Style/ Material	Vol. (mL) g-Max	Part No.	Quantity	Size (mm)	Required Caps / Spacers (qty. 1)	Adapters (qty. 6)	g-Force	k Factor	Max. Speed
Quick-Seal Polypropylene	1.5	344624	50	11 x 25	344674	-	485 000	32	60 000
	1.5	357323[§]	50	11 x 25	344674	-	485 000	24	60 000
	2.0	344625	50	11 x 32	344674	-	485 000	36	60 000
	2.0	357324[§]	50	11 x 32	344674	-	485 000	29	60 000
Quick-Seal konical Polypropylene	1.3	358655	50	11 x 35	344674	358152	485 000	30	60 000
	3.0	358648	50	11 x 60	344674	358152	485 000	45	60 000
Thinwall Polypropylene	4.0	328874*	50	11 x 60	-	-	485 000	45	60 000
Thinwall konical Polypropylene	1.5	358117	50	11 x 60	-	358152	485 000	45	60 000
	3.0	358118	50	11 x 60	-	358152	485 000	45	60 000
Thickwall Polypropylene	3.0	355636	25	11 x 60	-	-	485 000	45	60 000
Thickwall Polycarbonate	3.0	355635	50	11 x 60	-	-	485 000	45	60 000
Ultra-Clear	4.0	344062*	50	11 x 60	-	-	485 000	45	60 000

Sterile and Certified-Free Tubes												
Tube Style/ Material	Vol. (mL) g-Max	Size (mm)	Beckman Standard Part Number	Certified Free Part Number	Qty	Sterile Part Number	Qty	Required Caps / Spacers (qty. 1)	Required Adapters (qty. 1)	g-Force	k Factor	Max. Speed
Ultra-Clear	4	11 x 60	344062	C14282	50	C14298	48	-	-	485 000	45	60 000
Polypropylene	4	11 x 60	328874	C18669	50	C18674	48	-	-	485 000	45	60 000

Note: To help you locate g-Max tubes in the rotor listings, these tubes are highlighted with bold, italic type.

§ To simplify ordering, this g-Max Kit includes enough spacers to fill rotor, 50 tubes and required tools.

* Sterile and C-Free options available.

Rotor Replacement Parts

331155	Overspeed Disk, 60 000 rpm
331313	Bucket Holder Rack
C46871	Rotor Stand
335645	Bucket Cap (each)
337943	Bucket Assembly, Titanium, with Caps and O-rings, matched set of 6
868638	O-ring for Bucket

Adapters/Spacers

344674 358152



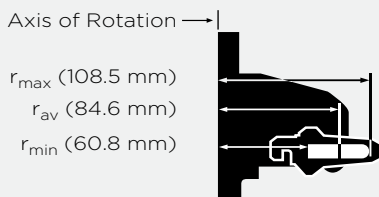

Swinging-Bucket Rotor, Titanium Head, and Buckets (red buckets)

For use in instruments classified: H R S
Major applications: Rate-zonal separations of small particles.

Max. RPM	Max. <i>g</i>	<i>k</i> Factor	Number of Tubes Volume/Size	Rotor Capacity
55 000	368 000	48	6 x 5 mL ½ x 2 in 13 x 51 mm	30 mL

No. 342196. SW 55 Ti Rotor Package. Includes Rotor, 2 boxes 326819 Polypropylene Tubes, 2 boxes 344057 Ultra-Clear Tubes, 1 each 330070 Hinge Pin Tool, 331313 Bucket Holder Rack, 306812 Spinkote Lubricant, 335148 Vacuum Grease, 328896 Overspeed Disk, and 24 each 824412 O-rings.

No. 342194. SW 55 Ti Rotor Assembly.

No. 361661. OptiSeal Tube Kit with 4 boxes 361627 OptiSeal Polypropylene Tubes, 6 Spacers 361678 (3 pkg of 2), 1 OptiSeal Tube Rack 361650, and 1 Tube Extraction Tool 361668.

Tubes and Bottles									
Tube Style/ Material	Vol. (mL) <i>g</i> -Max	Part No.	Quantity	Size (mm)	Required Caps / Spacers (qty. 1)	Adapters (qty. 6)	<i>g</i> -Force	<i>k</i> Factor	Max. Speed
OptiSeal Polypropylene	3.3	361627	56	13 x 33	361678 ^{§§}	-	368 000	48	55 000
Quick-Seal Polypropylene	2.0	345829	50	13 x 25	355535	-	368 000	29	55 000
	2.0	357327[§]	50	13 x 25	355535	-	368 000	29	55 000
Quick-Seal konical Polypropylene	3.2	358647	50	13 x 51	355535	358153	368 000	48	55 000
Thinwall Polypropylene	5.0	326819	50	13 x 51	-	-	368 000	48	55 000
Thinwall konical Polypropylene	3.0	358119	50	13 x 51	-	358153	368 000	48	55 000
Thickwall Polypropylene	3.5	349623	25	13 x 51	-	-	368 000	48	55 000
Thickwall Polycarbonate	3.5	349622	25	13 x 51	-	-	368 000	48	55 000
Ultra-Clear	0.8	344090	50	5 x 41	-	356860 ^{**}	269 000	64	48 000
	5.0	344057 [*]	50	13 x 51	-	-	368 000	48	55 000

Sterile and Certified-Free Tubes												
Tube Style/ Material	Vol. (mL) <i>g</i> -Max	Size (mm)	Beckman Standard Part Number	Certified Free Part Number	Qty	Sterile Part Number	Qty	Required Caps / Spacers (qty. 1)	Required Adapters (qty. 1)	<i>g</i> -Force	<i>k</i> Factor	Max. Speed
Ultra-Clear	5	13 x 51	344057	C14279	50	C14295	48	-	-	288 000	124	41 000

Note: To help you locate *g*-Max tubes in the rotor listings, these tubes are highlighted with bold, italic type.

§ To simplify ordering, this *g*-Max Kit includes enough spacers to fill rotor, 50 tubes and required tools.

§§ Set of 2.

* Sterile and C-Free options available.

** Adapter 305527 can be used for speed up to 25 000 rpm, set of 1.
73,200 x *g*, 209 *k* Factor, and 25,000 Max RPM

Rotor Replacement Parts

328896	Overspeed Disk, 55 000 rpm
331313	Bucket Holder Rack
C46871	Rotor Stand
342190	Bucket Cap (each)
342199	Bucket Assembly, Titanium, with Caps and O-rings, matched set of 6
824412	O-ring for Bucket

Adapters/Spacers			
355535	356860	358153	361678

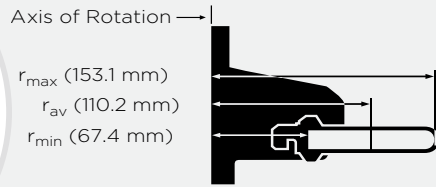

Swinging-Bucket Rotor, Titanium Head, and Buckets (black buckets)

For use in instruments classified: H R S
Major applications: Rate-zonal and isopycnic centrifugation of viruses, rate-zonal centrifugation of RNA.

Max. RPM	Max. <i>g</i>	<i>k</i> Factor	Number of Tubes Volume/Size	Rotor Capacity
41 000	288 000	124	6 x 13.2 mL 9/16 x 3 1/2 in 14 x 89 mm	79.2 mL

No. 331336. SW 41 Ti Rotor Package. Includes Rotor, 2 boxes 331372 Polypropylene Tubes, 2 boxes 344059 Ultra-Clear Tubes, 1 each 330070 Hinge Pin Tool, 331313 Bucket Holder Rack, 306812 Spinkote Lubricant, 335148 Vacuum Grease, 330335 Overspeed Disk, and 24 each 331309 Gaskets for Buckets.

No. 331362. SW 41 Ti Rotor Assembly.

Tubes and Bottles									
Tube Style/ Material	Vol. (mL) <i>g</i> -Max	Part No.	Quantity	Size (mm)	Required Caps / Spacers (qty. 1)	Adapters (qty. 6)	<i>g</i> -Force	<i>k</i> Factor	Max. Speed
Quick-Seal Polypropylene	3.5	355870	50	14 x 25	355534	-	288 000	34	41 000
	5.9	355537	50	14 x 47	355534	-	288 000	55	41 000
Quick-Seal konical Polypropylene	4.0	358650	50	14 x 48	355534	358154**	288 000	56	41 000
	8.0	358649	50	14 x 89	355534	358154**	288 000	108	41 000
Thinwall Polypropylene	13.2	331372*	50	14 x 89	-	-	288 000	124	41 000
Thinwall konical Polypropylene	10.2	358120	50	14 x 89	-	358154**	288 000	124	41 000
Ultra-Clear	13.2	344059*	50	14 x 89	-	-	288 000	124	41 000

Sterile and Certified-Free Tubes												
Tube Style/ Material	Vol. (mL) <i>g</i> -Max	Size (mm)	Beckman Standard Part Number	Certified Free Part Number	Qty	Sterile Part Number	Qty	Required Caps / Spacers (qty. 1)	Required Adapters (qty. 1)	<i>g</i> -Force	<i>k</i> Factor	Max. Speed
Ultra-Clear	13.2	14 x 89	344059	C14277	50	C14293	48	-	-	288 000	124	41 000
Polypropylene	13.2	14 x 89	331372	C14286	50	C14302	48	-	-	288 000	124	41 000

Note: To help you locate *g*-Max tubes in the rotor listings, these tubes are highlighted with bold, italic type.

* Sterile and C-Free options available.

** Recommend P/N 354468 Extractor Tool (konical tube adapters).

Rotor Replacement Parts

330335	Overspeed Disk, 41 000 rpm
331309	Gasket for Bucket
331763	Caps, matched set of 6
331313	Bucket Holder Rack
C46871	Rotor Stand
333790	Bucket Assembly, Black Titanium, with Caps and Gaskets, matched set of 6

Adapters/Spacers	
355534	358154

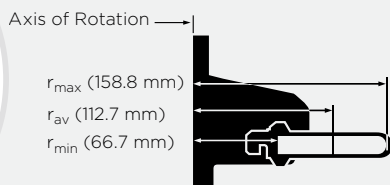

Swinging-Bucket Rotor, Titanium Head, and Buckets (red buckets)

For use in instruments classified: H R S

Major applications: Rate-zonal centrifugation of proteins, RNA and subcellular particles.

Max. RPM	Max. g	k Factor	Number of Tubes Volume/Size	Rotor Capacity
40 000	285 000	137	6 x 14 mL 9/16 x 3 3/4 in 14 x 95 mm	84 mL

No. 331301. SW 40 Ti Rotor Package. Includes Rotor, 2 boxes 331374 Polypropylene Tubes, 2 boxes 344060 Ultra-Clear Tubes, 1 each 330070 Hinge Pin Tool, 331313 Bucket Holder Rack, 306812 Spinkote Lubricant, 335148 Vacuum Grease, 330335 Overspeed Disk, and 24 each 331309 Gaskets for Buckets.

No. 331302. SW 40 Ti Rotor Assembly.

Tubes and Bottles									
Tube Style/ Material	Vol. (mL) <i>g-Max</i>	Part No.	Quantity	Size (mm)	Required Caps / Spacers (qty. 1)	Adapters (qty. 6)	g-Force	k Factor	Max. Speed
Quick-Seal Polypropylene	3.5	355870	50	14 x 25	355534	-	285 000	35	40 000
	5.9	355537	50	14 x 47	355534	-	285 000	61	40 000
Quick-Seal konical Polypropylene	4.0	358650	50	14 x 48	355534	358154**	285 000	57	40 000
	8.0	358649	50	14 x 89	355534	358154**	285 000	107	40 000
	4.0	355580	50	14 x 48	355534	358154**	285 000	56	40 000
Thinwall Polypropylene	14.0	331374*	50	14 x 95	-	-	285 000	137	40 000
Thinwall konical Polypropylene	10.0	358120	50	14 x 89	-	358154**	285 000	124	40 000
	11.0	358121	50	14 x 95	-	358154**	285 000	137	40 000
Ultra-Clear	14.0	344060*	50	14 x 95	-	-	285 000	137	40 000

Sterile and Certified-Free Tubes												
Tube Style/ Material	Vol. (mL) <i>g-Max</i>	Size (mm)	Beckman Standard Part Number	Certified Free Part Number	Qty	Sterile Part Number	Qty	Required Caps / Spacers (qty. 1)	Required Adapters (qty. 1)	g-Force	k Factor	Max. Speed
Ultra-Clear	14	14 x 95	344060	C14278	50	C14294	48	-	-	285 000	137	40 000
Polypropylene	14	14 x 95	331374	C14287	50	C14303	48	-	-	285 000	137	40 000

Note: To help you locate *g-Max* tubes in the rotor listings, these tubes are highlighted with bold, italic type.

- * Sterile and C-Free options available.
- ** Recommend P/N 354468 Extractor Tool (konical tube adapters).

Rotor Replacement Parts

330335	Overspeed Disk, 40 000 rpm
331309	Gasket for Bucket
331313	Bucket Holder Rack
331763	Caps, matched set of 6
C46871	Rotor Stand
333789	Bucket Assembly, Red Titanium, with Caps and Gaskets, matched set of 6

Adapters/Spacers	
355534	358154



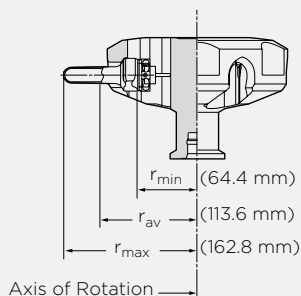

Swinging-Bucket Rotor and Buckets, Titanium

For use in instruments classified: H R S

Major applications: Separation of subcellular particles and viruses in density gradients.

Max. RPM	Max. g	k Factor	Number of Tubes Volume/Size	Rotor Capacity
32 000	187 000	229	6 x 17 mL 5/8 x 4 in 16 x 102 mm	102 mL

No. 369696. SW 32.1 Ti Rotor Package. Includes Rotor, 2 boxes 337986 Polypropylene Tubes, 2 boxes 344061 Ultra-Clear Tubes, 1 each 33186 Bucket Holder Rack, 306812 Spinkote Lubricant, 335148 Vacuum Grease, 335456 Overspeed Disk, 978354 hooked O-ring Removal Tool, and 24 each 812715 O-rings.

No. 369651. SW 32.1 Ti Rotor Assembly.

Tubes and Bottles									
Tube Style/ Material	Vol. (mL) <i>g-Max</i>	Part No.	Quantity	Size (mm)	Required Caps / Spacers (qty. 1)	Adapters (qty. 6)	<i>g</i> -Force	<i>k</i> Factor	Max. Speed
Quick-Seal Polypropylene	4.5	356562	50	16 x 32	355579	-	187 000	56	32 000
	6.5	345830	50	16 x 44	355579	-	187 000	79	32 000
	8.0	344621	50	16 x 57	355579	-	187 000	102	32 000
	10.5	344622	50	16 x 67	355579	-	187 000	133	32 000
	14.5	356291	50	16 x 102	355579	-	187 000	199	32 000
Quick-Seal konical Polypropylene	12.5	358653	50	16 x 102	355579	358155	187 000	205	32 000
Thinwall Polypropylene	16.5	337986	50	16 x 96	-	-	187 000	228	32 000
Thinwall konical Polypropylene	13.5	358123	50	16 x 93	-	358155	187 000	225	32 000
Ultra-Clear	17.0	344061*	50	16 x 102	-	-	187 000	228	32 000

Sterile and Certified-Free Tubes												
Tube Style/ Material	Vol. (mL) <i>g-Max</i>	Size (mm)	Beckman Standard Part Number	Certified Free Part Number	Qty	Sterile Part Number	Qty	Required Caps / Spacers (qty. 1)	Required Adapters (qty. 1)	<i>g</i> -Force	<i>k</i> Factor	Max. Speed
Ultra-Clear	17	16 x 102	344061	C14281	50	C14297	48	-	-	187 000	228	32 000

Note: To help you locate *g*-Max tubes in the rotor listings, these tubes are highlighted with bold, italic type.

* Sterile and C-Free options available.

Rotor Replacement Parts

33186	Bucket Holder Rack
C46871	Rotor Stand
335456	Overspeed Disk, 32 000 rpm
369645	Bucket Cap (each)
369693	Bucket Assembly, with Caps and O-rings, set of 6
812715	O-ring for Bucket

Extra Buckets for the SW 32.1 Ti

The buckets of the SW 32 can be used with the SW 32.1 rotor head. 369692 Bucket Assembly, with Caps and O-rings, set of 6

Adapters/Spacers	
355579	358155

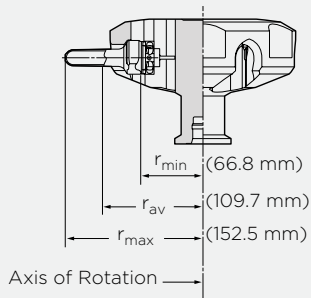

Swinging-Bucket Rotor and Buckets, Titanium

For use in instruments classified: H R S

Major applications: Separation of subcellular particles and viruses in density gradients.

Max. RPM	Max. g	k Factor	Number of Tubes Volume/Size	Rotor Capacity
32 000	175 000	204	6 x 38.5 mL 1 x 3.5 in 25 x 89 mm	231 mL

No. 369694. SW 32 Ti Rotor Package. Includes Rotor, 1 box 326823 Polypropylene Tubes, 2 boxes 344058 Ultra-Clear Tubes, 1 box 355631 Polycarbonate Tubes, 1 each 331186 Bucket Holder Rack, 306812 Spinkote Lubricant, 335148 Vacuum Grease, 335456 Overspeed Disk, 978354 hooked O-ring Removal Tool, and 24 each 812715 O-rings.

No. 369650. SW 32 Ti Rotor Assembly.

Tubes and Bottles									
Tube Style/ Material	Vol. (mL) g-Max	Part No.	Quantity	Size (mm)	Required Caps / Spacers (qty. 1)	Adapters (qty. 6)	g-Force	k Factor	Max. Speed
OptiSeal Polypropylene	32.4	361625	50	26 x 77	392833^{§§}	-	175 000	155	32 000
Quick-Seal Polypropylene Bell-Top	15.0	343664	50	25 x 38	355536	-	175 000	81	32 000
	27.0	343665	50	25 x 64	355536	-	175 000	146	32 000
	33.5	344623	50	25 x 83	355536	-	175 000	192	32 000
Quick-Seal konical Polypropylene Bell-Top	8.4	358652	50	25 x 38	355536	358156	175 000	74	32 000
	22.5	358654	50	25 x 76	355536	358156	175 000	155	32 000
	28.0	358651	50	25 x 83	355536	358156	175 000	198	32 000
Thinwall konical Polypropylene	25.5	358125	50	25 x 76	-	358156	175 000	156	32 000
	31.5	358126*	50	25 x 89	-	358156	175 000	199	32 000
Thickwall Polypropylene	31.0	355642	25	25 x 89	-	-	175 000	198	32 000
Thinwall Polypropylene	38.5	326823*	50	25 x 89	-	-	175 000	204	32 000
Thickwall Polycarbonate	31.0	355631	25	25 x 89	-	-	175 000	202	32 000
Ultra-Clear	38.5	344058*	50	25 x 89	-	-	175 000	204	32 000

Sterile and Certified-Free Tubes												
Tube Style/ Material	Vol. (mL) g-Max	Size (mm)	Beckman Standard Part Number	Certified Free Part Number	Qty	Sterile Part Number	Qty	Required Caps / Spacers (qty. 1)	Required Adapters (qty. 1)	g-Force	k Factor	Max. Speed
Ultra-Clear	38.5	25 x 89	344058	C13926	50	C14292	48	-	-	175 000	204	32 000
Polypropylene	38.5	25 x 89	326823	C14285	50	C14301	48	-	-	175 000	204	32 000
Polypropylene konical	30	25 x 89	358126	C14291	50	C14307	48	-	358156	175 000	199	32 000

Note: To help you locate g-Max tubes in the rotor listings, these tubes are highlighted with bold, italic type.

§§ Set of 2.

* Sterile and C-Free options available.

Rotor Replacement Parts

331186	Bucket Holder Rack
C46871	Rotor Stand
335456	Overspeed Disk, 32 000 rpm
369643	Bucket Cap (each)
369692	Bucket Assembly, with Caps and O-rings, set of 6
812715	O-ring for Bucket

Extra Buckets for the SW 32 Ti

The buckets of the SW 32.1 can be used with the SW 32 rotor head. 369693 Bucket Assembly, with Caps and O-rings, set of 6

Adapters/Spacers		
355536	358156	392833

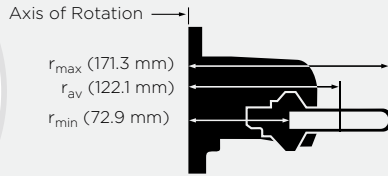

Swinging-Bucket Rotor, Aluminum Head, and Titanium Buckets

For use in instruments classified: H R S

Note: Zonal support band (if installed in centrifuge) must be removed before operating this rotor.

Major applications: Rate-zonal centrifugation of subcellular particles and viruses, rate-zonal centrifugation of subcellular fractions.

Max. RPM	Max. g	k Factor	Number of Tubes Volume/Size	Rotor Capacity
28 000	150 000	275	6 x 17 mL 5/8 x 4 in 16 x 102 mm	102 mL

No. 342214. SW 28.1 Rotor Package. Includes Rotor, 2 boxes 337986 Polypropylene Tubes, 2 boxes 344061 Ultra-Clear Tubes, 1 each 331186 Bucket Holder Rack, 306812 Spinkote Lubricant, 335148 Vacuum Grease, 342211 Overspeed Disk, and 24 each 815472 O-rings.

No. 342216. SW 28.1 Rotor Assembly.

Tubes and Bottles									
Tube Style/ Material	Vol. (mL) g-Max	Part No.	Quantity	Size (mm)	Required Caps / Spacers (qty. 1)	Adapters (qty. 6)	g-Force	k Factor	Max. Speed
Quick-Seal Polypropylene	4.2	356562	50	16 x 38	355579	-	150 000	63	28 000
	6.3	345830	50	16 x 44	355579	-	150 000	90	28 000
	8.0	344621	50	16 x 57	355579	-	150 000	117	28 000
	10.0	344622	50	16 x 67	355579	-	150 000	154	28 000
	18.0	356291	50	16 x 102	355579	-	150 000	229	28 000
Quick-Seal konical Polypropylene	12.5	358653	50	16 x 102	355579	358155	148 000	235	28 000
Thinwall Polypropylene	17.0	337986	50	16 x 96	-	-	150 000	275	28 000
Thinwall konical Polypropylene	14.5	358123	50	16 x 93	-	358155	148 000	271	28 000
Ultra-Clear	17.0	344061*	50	16 x 102	-	-	150 000	275	28 000

Sterile and Certified-Free Tubes												
Tube Style/ Material	Vol. (mL) g-Max	Size (mm)	Beckman Standard Part Number	Certified Free Part Number	Qty	Sterile Part Number	Qty	Required Caps / Spacers (qty. 1)	Required Adapters (qty. 1)	g-Force	k Factor	Max. Speed
Ultra-Clear	17	16 x 102	344061	C14281	50	C14297	48	-	-	150 000	275	28 000

Note: To help you locate g-Max tubes in the rotor listings, these tubes are highlighted with bold, italic type.

* Sterile and C-Free options available.

Rotor Replacement Parts

331186	Bucket Holder Rack
C46871	Rotor Stand
342180	Bucket Cap (each)
342211	Overspeed Disk, 28 000 rpm
342212	Bucket Assembly, Titanium, with Caps and O-rings, matched set of 6
815472	O-ring for Bucket

Extra Buckets for the SW 28.1

The large-volume buckets of the SW 28 can be used with the SW 28.1 rotor head.

342217	Bucket Assembly SW 28, Titanium, with Caps and O-rings, matched set of 6
--------	--

Adapters/Spacers	
355579	358155



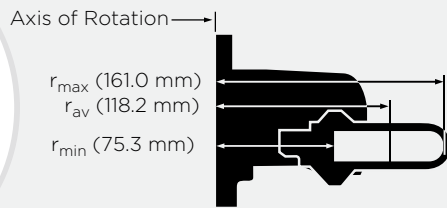

Swinging-Bucket Rotor, Aluminum Head, and Titanium Buckets

For use in instruments classified: H R S

Major applications: Differential centrifugation of subcellular fractions and viruses.

Max. RPM	Max. g	k Factor	Number of Tubes Volume/Size	Rotor Capacity
28 000	141 000	246	6 x 38.5 mL 1 x 3 1/2 in 25 x 89 mm	231 mL

No. 342204. SW 28 Rotor Package. Includes Rotor, 2 boxes 326823 Polypropylene Tubes, 2 boxes 344058 Ultra-Clear Tubes, 1 each 331186 Bucket Holder Rack, 306812 Spinkote Lubricant, 335148 Vacuum Grease, 342211 Overspeed Disk, and 24 each 812715 O-rings.

No. 342207. SW 28 Rotor Assembly.

Tubes and Bottles									
Tube Style/ Material	Vol. (mL) g-Max	Part No.	Quantity	Size (mm)	Required Caps / Spacers (qty. 1)	Adapters (qty. 6)	g-Force	k Factor	Max. Speed
OptiSeal Polypropylene	32.4	361625	50	26 x 77	392833 ^{§§}	-	141 000	246	28 000
Quick-Seal Polypropylene Bell-Top	15.0 27.0 33.0	343664 343665 344623	50 50 50	25 x 38 25 x 64 25 x 83	355536 355536 355536	- - -	141 000 134 000 141 000	92 180 233	28 000 28 000 28 000
Quick-Seal konical Polypropylene Bell-Top	8.5 23.0 28.0	358652 358654 358651	50 50 50	25 x 38 25 x 76 25 x 83	355536 355536 355536	358156 358156 358156	139 000 139 000 139 000	84 178 226	28 000 28 000 28 000
Thinwall konical Polypropylene	25.0 30.0	358125 358126*	50 50	25 x 76 25 x 89	- -	358156 358156	139 000 139 000	190 240	28 000 28 000
Thickwall Polypropylene	32.0	355642	25	25 x 89	-	-	141 000	241	28 000
Thinwall Polypropylene	38.5	326823*	50	25 x 89	-	-	141 000	246	28 000
Thickwall Polycarbonate	32.0	355631	25	25 x 89	-	-	141 000	246	28 000
Ultra-Clear	38.5	344058*	50	25 x 89	-	-	141 000	246	28 000

Sterile and Certified-Free Tubes												
Tube Style/ Material	Vol. (mL) g-Max	Size (mm)	Beckman Standard Part Number	Certified Free Part Number	Qty	Sterile Part Number	Qty	Required Caps / Spacers (qty. 1)	Required Adapters (qty. 1)	g-Force	k Factor	Max. Speed
Ultra-Clear	38.5	25 x 89	344058	C13926	50	C14292	48	-	-	141 000	246	28 000
Polypropylene	38.5	25 x 89	326823	C14285	50	C14301	48	-	-	141 000	246	28 000
Polypropylene konical	30	25 x 89	358126	C14291	50	C14307	48	-	358156	139 000	240	28 000

Note: To help you locate g-Max tubes in the rotor listings, these tubes are highlighted with bold, italic type.

§§ Set of 2.

* Sterile and C-Free options available.

Rotor Replacement Parts

331186	Bucket Holder Rack
C46871	Rotor Stand
342179	Bucket Cap (each)
342211	Overspeed Disk, 28 000 rpm
342217	Bucket Assembly, Titanium, with Caps and O-rings, matched set of 6
812715	O-ring for Bucket

Extra Buckets for the SW 28

The long slender buckets of the SW 28.1 can be used with the SW 28 rotor head.

342212	Bucket Assembly SW 28.1, Titanium, with Caps and O-rings, matched set of 6
--------	--

Adapters/Spacers





Continuous Flow Rotor, Titanium

For use in instruments classified: H S

Major applications: Isopycnic banding of viruses.

Max. RPM	Max. g	k Factor	Rotor Capacity
32 000	102 000	42	430 mL

CF-32 Ti Rotor Kit

No. 350700. Basic Rotor Kit. Use with Optima X and L Series
 No. 350867 CF-32 Rotor (Rotor, Lid, O-ring)

CF-32 Ti Rotor Packages (for field installation of Optima X and L Series instruments)

Includes: Basic Rotor Kit, Door Kit, Adapter Bowl Assembly, and Vacuum Pump.

A19656 CF-32 Rotor Package for Optima L Series, 60 Hz

A19655 CF-32 Rotor Package for Optima L Series, 50 Hz

B10406 CF-32 Rotor Package for Optima X Series, 60 Hz

B10463 CF-32 Rotor Package for Optima X Series, 50 Hz

CF-32 Ti Accessories

354474	Door Kit and Hardware for Optima L/XL Series
A95570	Door Kit and Hardware for Optima X Series
B10464	Adapter Bowl Kit for Optima X and L Series
358922	CF-32 Aspirator Vacuum Pump, 120 V
358923	CF-32 Aspirator Vacuum Pump, 220 V
961778	Vibration Mount, Optima (each; 3 needed)
355911	Vibration Mount, L/L2/L3/L5/L8 (set of 3)
354192	Standoff, CF-32 (sold in quantity of 1)

Note: A continuous-output gradient pump able to operate against a backpressure of 20 psi (138 kPa) is also required. The purchased pump must be able to provide a flow of up to 150 mL/min. (9 L/hr) and the pump head must accept 1/8-in. (3-mm) I.D. tubing. We recommend a Masterflex pump that can be purchased directly from the manufacturer: www.masterflex.com

Rotor Replacement Parts

011167	O-ring for Stem Assembly
303636	Backup Washer (red fiber)
328946	Gasket for Rotor Lid
328949	Non-extrusion Ring
335222	Vane for Core
335303	Core Handle
335456	Overspeed Disk, 32 000 rpm
885203	Adapter Bowl O-ring
354680	Septa Assembly
807446	Fitting, Stainless Steel
841687	Small O-ring in Stem Assembly

Seal Assembly Replacement Parts

008025	O-ring under Rotating Seal (large)
010177	O-ring in Static Seal Assembly (medium)
011920	O-ring in Static Seal Assembly (small)
010426	O-ring in Rotating Seal (small)
020198	O-ring in Bearing Base
335233	Adapter Bowl Flat Gasket/Pad
354460	Static Seal Assembly
354458	Rotating Seal
853156	O-ring in Static Seal Assembly (large)
870030	Spring in Manifold
870315	O-ring in Manifold
354307	CF-32 Stem Assembly/Bearing Kit: Includes a matched and serialized set of Stem Holder Assembly and Bearing Assembly.

Note: The CF-32 Ti Rotor cannot be used in Beckman Coulter ultracentrifuges that have been modified with the Prep UV-Scanner or Schlieren accessories.

††† Available only as part of Stem Assembly/Bearing Kit, P/N 354307.

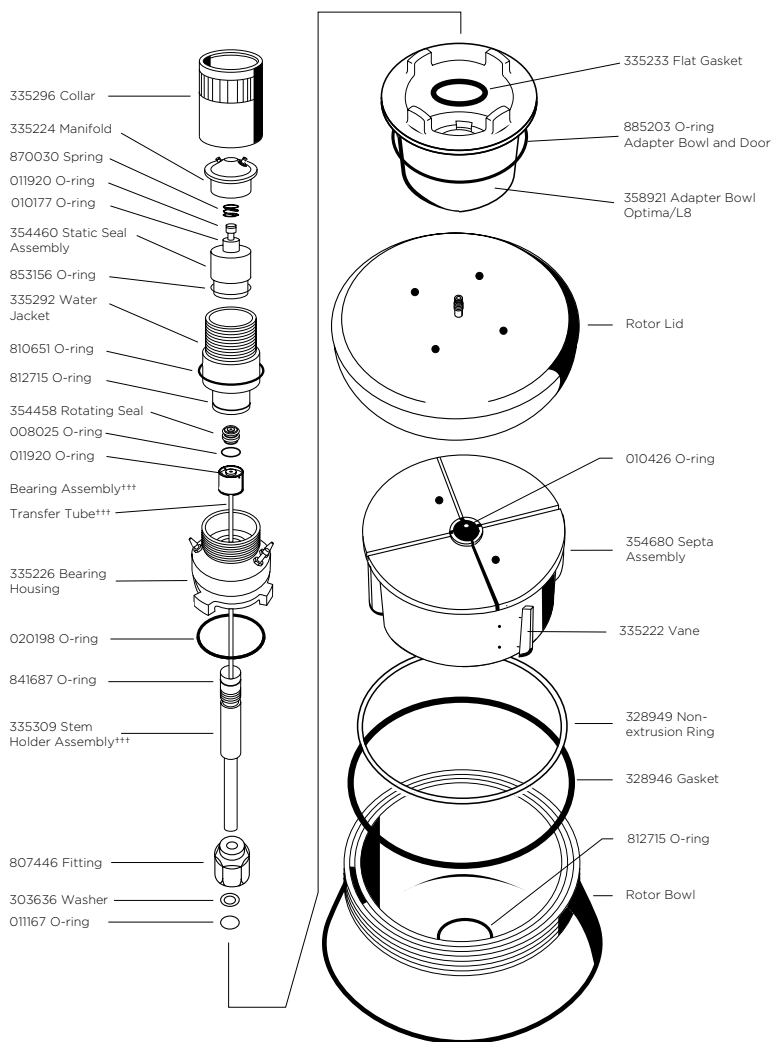



Zonal Rotor, Titanium

For use in instruments classified: H S

Note: Solutions in the pH range of 4 to 10 can be used in this Titanium rotor.

Major applications: Rate-zonal centrifugation of subcellular particles.

Max. RPM	Max. g	Rotor Capacity	Typical Sample Volume	Particle Pathlength
32 000	102 000	1,675 mL	50-200 mL	7.5 cm

No. 969312 Type Ti-15 Titanium Zonal Rotor and Lid with Standard Core
 No. 969313 Type Ti-15 Titanium Zonal Rotor and Lid with B29 Core
 No. 369622 Type Ti-15 Titanium Zonal Rotor and Lid without Core
 All above include 332676 Push-Pull Cap and Spare Parts/Supplies - 335148 Vacuum Grease, 306812 Spinkote Lubricant, 2 extra 335456 Overspeed Disks, and O-rings. (Seal Assembly, Mounting Hardware, and Tool Kit also required.)

Note: A continuous-output gradient pump able to operate against a backpressure of 20 psi (138 kPa) is also required. The purchased pump must be able to provide a flow of up to 50 mL/min. (3 L/hr) and the pump head must accept 1/8-in. (3-mm) I.D. tubing. We recommend a Masterflex pump that can be purchased directly from the manufacturer: www.masterflex.com

Replacement Parts for the Ti-15 Rotor and the Discontinued Al-15 Rotor

328946	Rotor Gasket
328949	Non-extrusion Ring
332676	Push-Pull Cap
333857	Rotor Core, Noryl
	815472 O-ring, top of Rotor Core
	011167 O-ring for Seal Fitting
	812715 O-ring, bottom of Rotor Core
	332682 Cone
	011519 O-ring, interior of Cap
	332691 Seal Fitting
	012780 O-ring, visible, on Cap
335456	Ti-15 Overspeed Disk, 32 000 rpm
336821	Ti-15 Overspeed Disk, 29 000 rpm

Tool Kits/Additional Parts

328917	Rotor Tool Kit
332688	Rotor Vise
332690	Spanner Wrench
333763	Tubing Removal Tool
858532	Pliers
354192	Standoff (qty. 3 req'd for field installations)
961778	Vibe Mount (qty. 3 req'd for field installations)

B-29 Type Core for Al/Ti-15 Rotors

No. 350474. This core for introduction of sample solution and recovery of fractions from the edge as well as the center of the zonal rotor is readily interchangeable with the standard cores. The ability to load the zonal rotor from the edge can greatly facilitate flotation-type runs. Also isopycnic banding in cesium chloride can be economically extended to Titanium zonal rotors with the B-19 Type core.

Reograd Type Core

No. 352125. Gradient is loaded and unloaded while rotor is at rest. Gradient reorients during acceleration and reorients upon deceleration. Does not require zonal seal assembly or mounting hardware. The rotor is loaded using a special cap (supplied with the core) with inlet and outlet. The cap is replaced with the standard rotor cap for the run. This core is particularly useful for lipoprotein subfractionation.

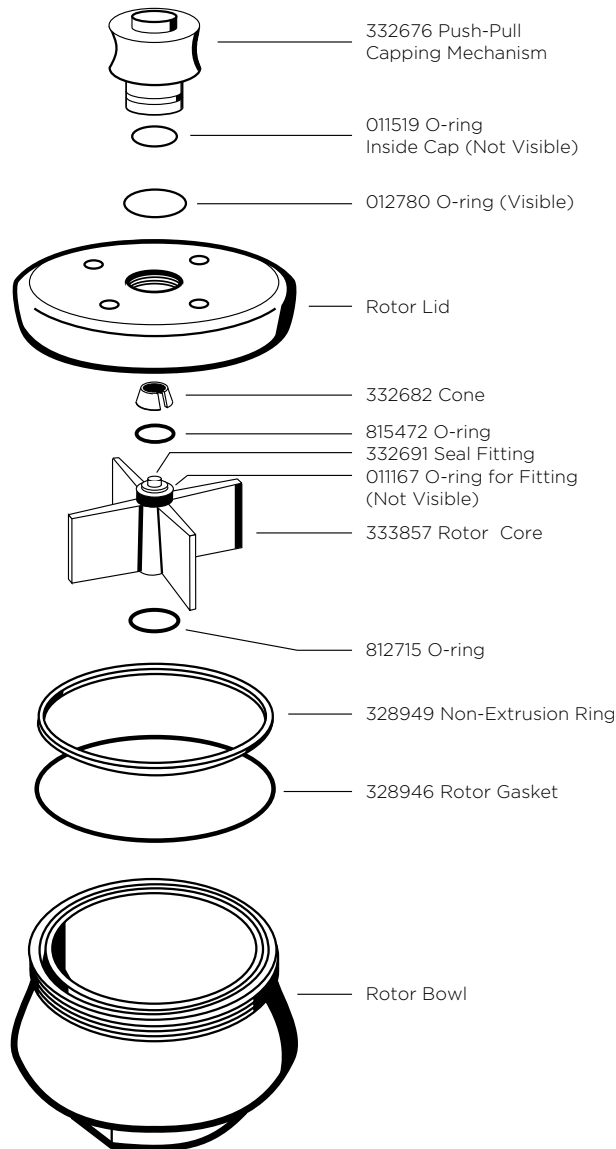



For Zonal Rotors

For use in instruments classified: H S

The Seal Assembly holds the lines through which fluids are introduced and withdrawn while the rotor is spinning at 2000 rpm. The assembly may be used with any of the Beckman Coulter zonal rotors in any Beckman Coulter preparative ultracentrifuge.

An order of a Seal Assembly should include three part numbers:
 1. Seal Assembly, 334241
 2. Tool Kit, 328917
 3. Appropriate Mounting Hardware

If the Seal Assembly is to be used in more than one instrument, Mounting Hardware should be ordered for each instrument. If a Z-60 Rotor is to be run in an instrument in which the Ti-14 Rotor will be used, the 336830 Support Band Kit also should be ordered (no charge).

Important Reminder: Seal Assemblies for earlier zonal rotors cannot be used with the new rotors. To distinguish the new Seal Assembly from the earlier version, check the rotating and stationary seals; in the newer assembly, both seals are contained in a single unit, in the manifold assembly (see diagram).

Mounting Hardware

337890 Hardware for any L8M, L8, Optima XL

Optimas with Ti 15 rotors require each of the following parts:

354192 Standoff (quantity required: 3)

961778 Vibe Mount (quantity required: 3)

We recommend the Cole Parmer #7520-40 Pump with #7015-21 Pump Head which can be purchased directly from the manufacturer: www.masterflex.com

Installation Requirements

The Mounting Hardware will be installed by a Beckman Coulter Service Representative at no extra cost. In addition to the Gradient Pump, the following installation necessities not supplied by Beckman Coulter are needed: a syringe (50 or 100 mL) for introducing sample, and two hemostats or other clamping devices to shut off tubing lines when necessary.

Replacement Parts for Seal Assembly

011167	O-ring, top of Stationary Seal
328951	Rotating Rulon Seal, for Seal Assembly
328952	Stationary Seal, two-piece construction
332618	Seal Disassembly Tool
333743	Bearing and Assembly
802173	Washer, for Bearing Cup
811656	O-ring, outer perimeter, Stationary Seal
819527	O-ring, for Bearing Assembly
824412	O-ring, center top of Stationary Seal
828628	Screw, for Bearing Cup
868638	O-ring, for Rotating Seal
858505	Spring, for Seal Assembly
328954	Manifold

Tool Kits

328917	Rotor Tool Kit
332688	Rotor Vise
332690	Spanner Wrench
333763	Tubing Removal Tool
858532	Pliers

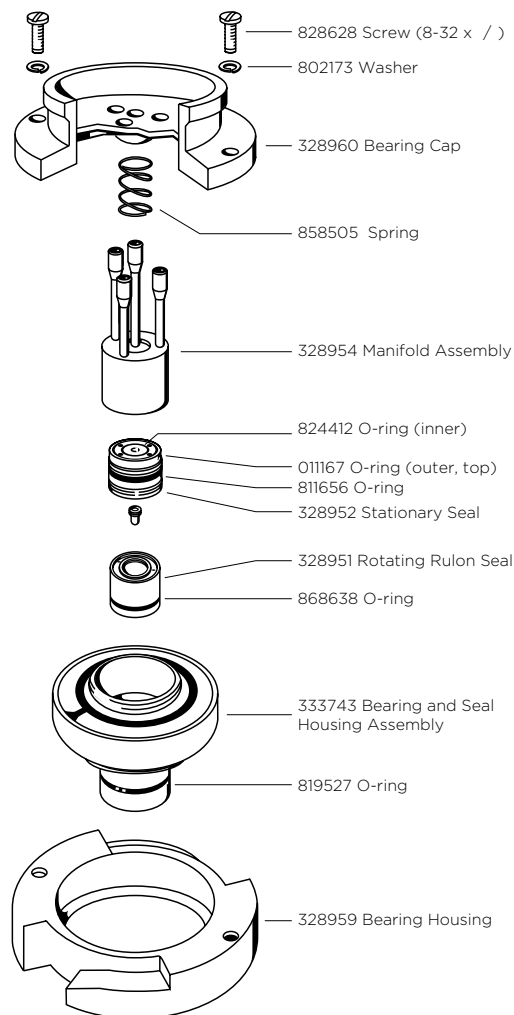

TABLETOP ULTRACENTRIFUGATION

Optima MAX Series Tabletop Preparative Ultracentrifuges



Elevating your laboratory's potential starts with the optimal tabletop ultracentrifuge. And the Optima MAX Series is the absolute top of the line. Reaching up to 150,000 rpm and over 1,000,000 x g, the Optima MAX instruments set the standard in tabletop speed. Our entry-level model, the MAX-TL, is designed for optimum functionality and efficiency within a compact, quiet package. Our premium model, the Optima MAX-XP, delivers advanced software with password-controlled security features, remote control capability, higher speed, and a wider rotor portfolio. The Optima MAX Series takes sophistication and total system design to a whole new level.

Full-color LCD touch-screen display

Easy to read and navigate. Intuitive graphical interface with on-screen help. Multilingual software supporting 9 major languages.

Remote monitoring and control (Optima MAX-XP Only)

Saves time. Start, stop, and monitor from your computer. Requires Remote Control Kit (P/N 393395), sold separately.

BioSafety options

The optional HEPA filter combines with innovative Beckman Coulter rotors and labware to offer a multi-layered approach to BioSafety.

Security and tracking features (Optima MAX-XP Only)

Manage rotor life by serial number. Track detailed usage history. Password protection helps you maintain chain of custody and compliance.

Trusted by researchers

95% of published protocols citing tabletop or micro-ultracentrifuges reference a Beckman Coulter instrument or rotor. (Source: 2009 Google Scholar search)

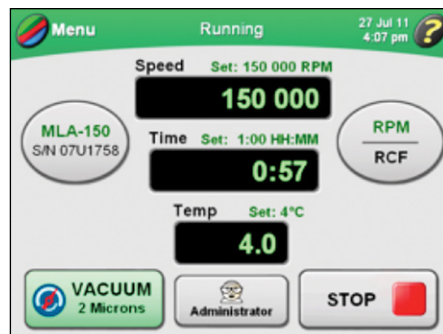

Part Numbers*			
Model	Instrument	BioSafe Package**	Remote Control Package
Optima MAX-XP	393315	A47882 BIOE	393395
Optima MAX-TL	A95761	B11229 BIOE	

* Availability varies by geography. Contact your local sales representative to determine the correct part number for ordering.

** BioSafe Package includes centrifuge and HEPA/Pharmaceutical-Grade Sterilizing filter kit PN 350799

Not intended or validated for use in the diagnosis of disease or other conditions.

1. Analytical UC
2. Floor Prep UC
3. Tabletop UC
4. Micro-UC
5. Tubes
6. Accessories
7. Reference
8. Support

TABLETOP ULTRACENTRIFUGATION

Features	Optima MAX-XP	Optima MAX-TL
LCD touchscreen display	●	●
Intuitive, multilingual interface	●	●
Numerical vacuum display	●	●
User-defined programs	●	●
TL rotor compatibility	●	●
ML rotor compatibility	●	
Password protection and user profiles	●	
Exportable run logs	●	
Rotor logging by serial number	●	
Remote monitoring and control option	●	
RPM or RCF user selectable	●	
On-screen rotor library	●	

Specifications		
	Optima MAX-XP	Optima MAX-TL
Maximum speed (rpm)	150,000	120,000
Maximum RCF (x g)	1,019,000	657,000
Speed control	± 50 rpm at set speed	
Set temperature	0 to 40°C in 1°C increments	
Temperature control	± 2°C of set temperature	
Ambient operating range	15 to 35°C	
Accel/decel profiles	10 accel/11 decel	
Operating languages	English, French, Italian, German, Spanish, Japanese, Russian, Korean, and Chinese (Simplified)	
User-defined programs	Virtually limitless	
User profiles	Yes	No
Rotor tracking	By serial number	No
Data transfer	USB 2.0 type A connectors	No
Heat output	2400 Btu/hr (0.7 kW)	
Drive cooling	Air-cooled	
Refrigeration system	Solid state - no CFCs, ODCs	
Sound level	<47 dBA	
Remote control	Available	No
HEPA filter	Available (Pharmaceutical-Grade Sterilizing Filter 0.2µm)	
Power requirement	200-240 VAC, 6 A, 50 Hz 120 VAC, 12 A, 50/60 Hz 100 VAC, 12 A, 50/60 Hz	
Dimensions (H x W x D)	34.5 (front left) 39.4 (rear right) x 73.9 x 61.7 cm 13.6 (front left) 15.5 (rear right) x 29.1 x 24.3 in	
Weight	105 kg (230 lb)	

1. Analytical UC

2. Floor Prep UC

3. Tabletop UC

4. Micro-UC

5. Tubes

6. Accessories

7. Reference

8. Support

TABLETOP ULTRACENTRIFUGATION

Quick-Reference Guide to Rotor Specifications and Tabletop Ultracentrifuge Compatibility

Rotor	Max. RPM	Max. <i>g</i>	<i>k</i> Factor	No. of Tubes x Nominal Tube Volume (mL)	Nominal Rotor Capacity (mL)	For Use in Instruments
TLA-120.2* BIOC	120 000	627 000	8	10 x 2.0	20	TL-100, Optima TL, Optima TLX, Optima MAX-XP, Optima MAX-TL
TLA-120.1 BIOE	120 000	627 000	8	14 x 0.5	7	TL-100, Optima TL, Optima TLX, Optima MAX-XP, Optima MAX-TL
TLA-110* BIOC	110 000	657 000	13	8 x 5.1	40.8	TL-100, Optima TL, Optima TLX, Optima MAX-XP, Optima MAX-TL
TLA-100.3 BIOE	100 000	541 000	14	6 x 3.5	21	TL-100, Optima TL, Optima TLX, Optima MAX-XP, Optima MAX-TL
TLA-100 BIOE	100 000	436 000	7	20 x 0.2	4	TL-100, Optima TL, Optima TLX, Optima MAX-XP, Optima MAX-TL
TLA-55* BIOC	55 000	186 000	66	12 x 1.5	18	TL-100, Optima TL, Optima TLX, Optima MAX-XP, Optima MAX-TL
TLS-55 BIOC	55 000	259 000	50	4 x 2.2	8.8	TL-100, Optima TL, Optima TLX, Optima MAX-XP, Optima MAX-TL
TLN-120 BIOE	120 000	585 000	7	8 x 1.2	9.6	TL-100, Optima TL, Optima TLX, Optima MAX-XP, Optima MAX-TL
TLN-100 BIOE	100 000	450 000	14	8 x 3.9	31.2	TL-100, Optima TL, Optima TLX, Optima MAX-XP, Optima MAX-TL
MLA-150 BIOE	150 000	989 000	10.4	8 x 2.0	16	Optima MAX-XP
MLA-130 BIOE	130 000	1 019 000	8.7	10 x 2.0	20	Optima MAX-XP
MLA-80 BIOE	80 000	444 000	29	8 x 8	64	Optima MAX-XP
MLA-55 BIOE	55 000	287 000	53	8 x 13.5	108	Optima MAX-XP
MLA-50 BIOE	50 000	233 000	92	6 x 32.4	194.4	Optima MAX-XP
MLS-50 BIOE	50 000	268 000	71	4 x 5	20	Optima MAX-XP
MLN-80 BIOE	80 000	389 000	20	8 x 8	64	Optima MAX-XP

* This rotor has been tested to demonstrate containment of microbiological aerosols only while operating within the associated Beckman Coulter centrifuge.

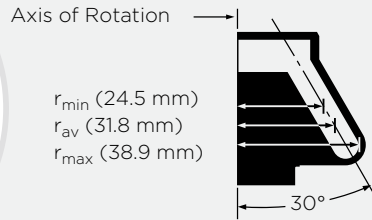

Fixed-Angle Rotor, Titanium

For use in the TL-100, Optima TL, Optima TLX, Optima MAX-XP and Optima MAX-TL ultracentrifuges.

Major applications: Pelleting of subcellular fractions in 5-30 minutes, plasmid DNA separation in 3 hours.

Max. RPM	Max. <i>g</i>	<i>k</i> Factor	Number of Tubes Volume/Size	Rotor Capacity
120 000	627 000	8	10 x 2.0 mL 11 x 34 mm	20 mL

No. 357656. TLA-120.2 Fixed-Angle Rotor Package. Includes BioCertified Rotor, 1 box 343778 Thickwall Polycarbonate Tubes, 1 each 348305 Tube Rack, 346133 Rotor Vise/Stand, 927208 Hemostats, 824412 and 854519 O-rings, 306812 Spinkote Lubricant, and 355148 Vacuum Grease.

No. 362046. TLA-120.2 Fixed-Angle Rotor Assembly.

Tubes and Bottles									
Tube Style/ Material	Vol. (mL) <i>g</i> -Max	Part No.	Quantity	Size (mm)	Required Caps / Spacers (qty. 1)	Adapters (qty. 1)	<i>g</i> -Force	<i>k</i> Factor	Max. Speed
Quick-Seal Polypropylene	1.5 2.0	344624 344625	50 50	11 x 25 11 x 32	344636 344674	- -	627 000 627 000	14 16	120 000 120 000
Thickwall Polypropylene	1.0	347287	100	11 x 34	-	-	279 000	18	80 000
Thickwall Polycarbonate	1.0	343778	100	11 x 34	-	-	627 000	8	120 000

Rotor Accessories	
301875	Spacer Removal Tool
345531	Quick-Seal Starter Kit, 11 x 25 mm, 1.5 mL Tubes. Includes 10 each 344636 Spacers, box of 344624 Tubes and 8 each 344643 Adapters (349387 Tube Topper Rack required).
345532	Quick-Seal Starter Kit, 11 x 32 mm, 2.0 mL Tubes. Includes 10 each 367310 Spacers, box of 344625 Tubes and 8 each 344644 Adapters (349387 Tube Topper Rack required).
346133	Rotor Vise Assembly
348305	Tube Rack for 11-mm Tubes (included with Rotor Package)
349387	Tube Topper Rack for 11-mm Tubes
362100	Tube Rack Adapter (set/8) for sealing Tubes 344624 [†]
362101	Tube Rack Adapter (set/8) for sealing Tubes 344625 [†]
927208	Hemostats, 6-in. curved
335148	Silicone Vacuum Grease (1 oz)
306812	Spinkote Lubricant (2 oz)

Rotor Replacements Parts	
349318	Cap & Plunger Assembly
362048	Rotor Lid Assembly.
824412	O-ring (inner, Rotor Lid)
854519	O-ring (outer, Rotor Lid)
346133	Rotor Vise

Note: To help you locate *g*-Max tubes in the rotor listings, these tubes are highlighted with bold, italic type.

√√ Required for obsolete Bench Quick Sealer.

≈ This rotor has been tested to demonstrate containment of microbiological aerosols only while operating within the associated Beckman Coulter centrifuge.

Adapters/Spacers	
344636	344674

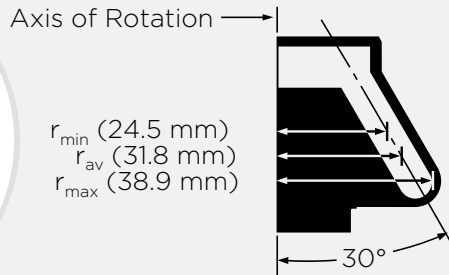

Fixed-Angle Rotor, Titanium

For use in the TL-100, Optima TL, Optima TLX, Optima MAX-XP and Optima MAX-TL ultracentrifuges.

Major applications: Pelleting of subcellular fractions in 5-30 minutes; plasmid DNA separation in 3 hours.

Max. RPM	Max. <i>g</i>	<i>k</i> Factor	Number of Tubes Volume/Size	Rotor Capacity
120 000	627 000	8	14 x 0.5 mL 8 x 34 mm	7 mL

No. 357655. TLA-120.1 Fixed-Angle Rotor Package. Includes Rotor, 1 box 343776 Thickwall Polycarbonate Tubes, 1 each 348304 Tube Rack, 346133 Rotor Vise/Stand, 927208 Hemostats, 824412 and 854519 O-rings, 306812 Spinkote Lubricant, and 355148 Vacuum Grease. No. 349490. TLA-100.3 Fixed-Angle Rotor Package. Includes Rotor, 1 box 349622 Thickwall Polycarbonate Tubes, 1 box 349623 Thickwall Polypropylene Tubes, 1 each 355919 (pkg. of 6) Spacers for 1.5 mL Microcentrifuge Tubes, 355872 Tube Rack, 824412 and 854521 O-rings, 927208 Hemostats, 346133 Rotor Vise/Stand, 306812 Spinkote Lubricant, and 335148 Vacuum Grease.

No. 362224. TLA-120.1 Fixed-Angle Rotor Assembly.

Tubes and Bottles									
Tube Style/ Material	Vol. (mL) <i>g</i> -Max	Part No.	Quantity	Size (mm)	Floating Spacers	Adapters	<i>g</i> -Force	<i>k</i> Factor	Max. Speed
Thickwall Polypropylene	0.5	343777	100	8 x 34	-	-	279 000	18	80 000
Thickwall Polycarbonate	0.5	343776	100	8 x 34	-	-	627 000	8	120 000

Rotor Accessories	
346133	Rotor Vise/Stand
347404	Rotor Cleaning Brush
348305	Tube Rack for 8-mm Tubes (included with Rotor Package)
927208	Hemostats

Rotor Replacement Parts	
349318	Cap & Plunger Assembly
362225	Rotor Lid Assembly (O-rings not included)
824412	O-ring (inner, Rotor Lid)
854519	O-ring (outer, Rotor Lid)

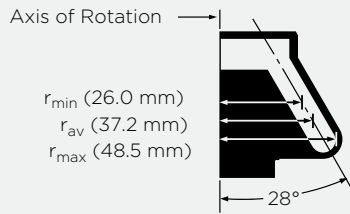

Fixed-Angle Rotor, Titanium

For use in the TL-100, Optima TL, Optima TLX, Optima MAX-XP and Optima MAX-TL ultracentrifuges.

Major applications: Moderate volume differential sedimentation (pelleting) of subcellular organelles and viruses.

Max. RPM	Max. g	k Factor	Number of Tubes Volume/Size	Rotor Capacity
110 000	657 000	13	8 x 5.1 mL 13 x 51 mm	40.8 mL

No. 366735. TLA-110 Fixed-Angle Rotor Package. Includes BioCertified Rotor, 1 box of 361621 OptiSeal Tubes, 8 each 361676 Floating Spacers, 854519 and 824412 O-ring, 348122 Tube Rack, 927208 Hemostats, 306812 Spinkote Lubricant, and 335148 Vacuum Grease.

Tubes and Bottles									
Tube Style/ Material	Vol. (mL)	Part No.	Quantity	Size (mm)	Required Caps / Spacers (qty. 8)	Adapters (qty. 8)	g-Force	k Factor	Max. Speed
Quick-Seal Polypropylene	5.1	343776	100	13 x 51	362307	-	627 000	13	110 000
OptiSeal Polypropylene Bell Top	4.7	361621	56	13 x 48	361676 ^{§§}	-	657 000	12	110 000
Quick-Seal Polypropylene Bell Top	2.0	345829	50	13 x 25	360270	-	657 000	5	110 000
	3.5	349621	50	13 x 32	360270	-	657 000	7	110 000
	5.1	362248	50	13 x 51	362307	-	657 000	13	110 000
Thickwall Polypropylene	3.2	362333	50	13 x 56	-	-	266 000	37	70 000
Thickwall Polycarbonate	3.2	362305	50	13 x 56	-	-	657 000	15	110 000
Microcentrifuge Polypropylene	1.5	357448	500	11 x 39	-	360951	206 000	19	70 000*
Corning Screw Cap Polypropylene	1.5	***	500	n/a	-	393238	536 000	9	110 000

§§ To help you locate g-Max tubes in the rotor listings, these tubes are highlighted with bold, italic type.

≈ This rotor has been tested to demonstrate containment of microbiological aerosols only while operating within the associated Beckman Coulter centrifuge.

* Maximum cycle time is 15 minutes at full rated speed

*** Commercially available product. Beckman Coulter does not sell Corning tubes.

Labcon 3611-870-000

Rotor Accessories	
306812	Spinkote Lubricant (2 oz)
335148	Silicone Vacuum Grease
338765	Spacer Removal Tool for 3.5-mL and 2.0-mL Quick-Seal Tube Spacers
339555	Beckman Solution 555 (1 qt)
339558	Rotor Cleaning Kit
342025	Fraction Recovery System
345832	Tube Rack Adapter for 13 x 25 mm, 2.0-mL Quick-Seal Tubes for use in 349487 Tube Rack ^{∇∇}
347404	Rotor Cleaning Brush
347828	Fraction Recovery System Adapter Kit for TL-series tubes
347960	Centri-Tube Slicer
348122	Tube Topper Rack for 13-mm Tubes (included in Rotor Package)
348299	CentriTube Slicer Replacement Blades (pkg of 10)
354526	CentriTube Slicer Adapter for 13-mm tubes
355582	Tube Rack Adapter for 13 x 32 mm, 3.5-mL Quick-Seal Tubes for use in 349487 Tube Rack ^{∇∇}

Rotor Accessories	
355872	Tube Rack for 13-mm Tubes
358312	Quick-Seal Cordless Tube Topper Kit, 60 Hz
358313	Quick-Seal Cordless Tube Topper Kit, 50 Hz (Europe)
358314	Quick-Seal Cordless Tube Topper Kit, 50 Hz (Great Britain)
358315	Quick-Seal Cordless Tube Topper Kit, 50 Hz (Australia)
361638	OptiSeal Tube Rack Assembly
361668	Tube Removal Tool
927208	Hemostats, 6-in. curved
961519	Hemostat, 6-in. straight

∇∇ Required for obsolete Bench Quick Sealer

Rotor Replacements Parts	
346133	Rotor Vise
347903	Spring
349477	Cap & Plunger Assembly
366732	Rotor Lid Assembly
824412	O-ring (inner, Rotor Lid)
854519	O-ring (outer, Rotor Lid)

Adapters/Spacers				
360270	360951	361676	362307	393238

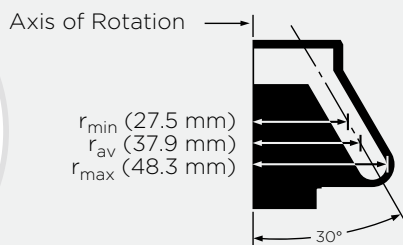
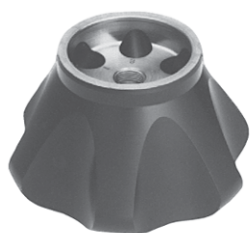

Fixed-Angle Rotor, Titanium

For use in the TL-100, Optima TL, Optima TLX, Optima MAX-XP and Optima MAX-TL ultracentrifuges.

Note: Non-precipitating solutions up to 1.7 g/mL in density can be run in this rotor without a reduction in rotor speed.

Major applications: Pelleting of subcellular fractions in 5-30 minutes; pelleting RNA in 1-2 hours; plasmid DNA separation in 6 hours

Max. RPM	Max. <i>g</i>	<i>k</i> Factor	Number of Tubes Volume/Size	Rotor Capacity
100 000	541 000	14	6 x 3.5 mL 13 x 51 mm	21 mL

No. 349481. TLA-100.3 Fixed-Angle Rotor Assembly.

No. 349490. TLA-100.3 Fixed-Angle Rotor Package. Includes Rotor, 1 box 349622 Thickwall Polycarbonate Tubes, 1 box 349623 Thickwall Polypropylene Tubes, 1 each 355919 (pkg. of 6) Spacers for 1.5 mL Microcentrifuge Tubes, 355872 Tube Rack, 824412 and 854521 O-rings, 927208 Hemostats, 346133 Rotor Vise/Stand, 306812 Spinkote Lubricant, and 335148 Vacuum Grease.

Tubes and Bottles									
Tube Style/ Material	Vol. (mL) <i>g</i> -Max	Part No.	Quantity	Size (mm)	Required Caps/ Spacers (qty. 6)	Required Adapters (qty. 6)	<i>g</i> -Force	<i>k</i> Factor	Max. Speed
Quick-Seal Polypropylene	2.0	345829	50	13 x 25	360270 ⁰⁰⁰	-	541 000	11	100 000
	3.5	349621	50	13 x 32	355937	-	541 000	14	100 000
Thickwall Polypropylene	3.0	349623	25	13 x 51	-	-	265 000	34	70 000
Thickwall Polycarbonate	3.0	349622	25	13 x 51	-	-	541 000	16	100 000
Microcentrifuge Polypropylene	1.5	357448	50	11 x 38	-	355919	245 000	24	70 000

Note: To help you locate *g*-Max tubes in the rotor listings, these tubes are highlighted with bold, italic type.

000 Package of 8.

Rotor Accessories	
306812	Spinkote Lubricant (2 oz)
335148	Silicone Vacuum Grease
338765	Spacer Removal Tool for 3.5-mL and 2.0-mL Quick-Seal Tube Spacers
339555	Beckman Solution 555 (1 qt)
339558	Rotor Cleaning Kit
342025	Fraction Recovery System
345832	Tube Rack Adapter for 13 x 25 mm
347404	Rotor Cleaning Brush
347828	Fraction Recovery System Adapter Kit for TL-series tubes
347960	Centri-Tube Slicer
348122	Tube Topper Rack for 13-mm Tubes
348299	CentriTube Slicer Replacement Blades (pkg of 10)
354526	CentriTube Slicer Adapter for 13mm tubes
355582	Tube Rack Adapter for 13 x 32 mm
355872	Tube Rack for 13-mm Tubes (included in Rotor Package)
358312	Quick-Seal Cordless Tube Topper Kit, 60 Hz

Rotor Accessories	
358313	Quick-Seal Cordless Tube Topper Kit, 50 Hz (Europe)
358314	Quick-Seal Cordless Tube Topper Kit, 50 Hz (Great Britain)
358315	Quick-Seal Cordless Tube Topper Kit, 50 Hz (Australia)
361668	Tube Removal Tool
927208	Hemostat, 6 in. curved
961519	Hemostat, 6 in. straight

√√ Required for obsolete Bench Quick Sealer

Rotor Replacements Parts	
346133	Rotor Vise
347903	Spring
349477	Cap & Plunger Assembly
349478	Rotor Lid Assembly
824412	O-ring (inner, Rotor Lid)
854521	O-ring (outer, Rotor Lid)

Adapters/Spacers		
355919	355937	360270

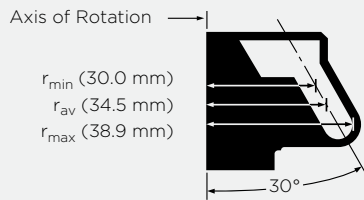

Fixed-Angle Rotor, Titanium

For use in the TL-100, Optima TL, Optima TLX, Optima MAX-XP and Optima MAX-TL ultracentrifuges.

Note: Non-precipitating solutions up to 1.7 g/mL in density can be run in this rotor without a reduction in rotor speed.

Major applications: PPelleting of subcellular fractions; proteins; RNA.

Max. RPM	Max. <i>g</i>	<i>k</i> Factor	Number of Tubes Volume/Size	Rotor Capacity
100 000	436 000	7	20 x 0.2 mL 7 x 20 mm	4 mL

No. 343837. TLA-100 Fixed-Angle Rotor Package. Includes Rotor, 1 box 343775 Thickwall Polycarbonate Tubes, 1 each 348302 Tube Rack, 824412 and 824953 O-rings, 927208 Hemostats, 346133 Rotor Vise/Stand, 306812 Spinkote Lubricant, and 335148 Vacuum Grease.

No. 343840. TLA-100 Fixed-Angle Rotor Assembly.

Tubes and Bottles									
Tube Style/ Material	Vol. (mL)	Part No.	Quantity	Size (mm)	Required Caps / Spacers (qty. 1)	Adapters (qty. 1)	<i>g</i> -Force	<i>k</i> Factor	Max. Speed
Thickwall Polypropylene	0.2	343621	100	7 x 20	-	-	279 000	10	80 000
Thickwall Polycarbonate	0.2	343775	100	7 x 20	-	-	436 000	7	100 000
Thickwall Cellulose Propionate	0.2	342303	100	7 x 20	-	-	184 000	16	65 000

Rotor Accessories	
306812	Spinkote Lubricant (2 oz)
335148	Silicone Vacuum Grease
339555	Beckman Solution 555 (1 qt)
339558	Rotor Cleaning Kit
342025	Fraction Recovery System
347404	Rotor Cleaning Brush
347828	Fraction Recovery System Adapter Kit for TL-series tubes
347960	Centri-Tube Slicer
348299	CentriTube Slicer Replacement Blades (pkg of 10)
348302	Tube Rack for 7-mm Tubes (included with Rotor Package)
361668	Tube Removal Tool
927208	Hemostats, 6-in. curved
961519	Hemostat, 6 in. straight

Rotor Replacements Parts	
343845	Rotor Lid Assembly (O-rings not included)
346133	Rotor Vise
349318	Cap & Plunger Assembly
824412	O-ring (inner, Rotor Lid)
824953	O-ring (outer, Rotor Lid)

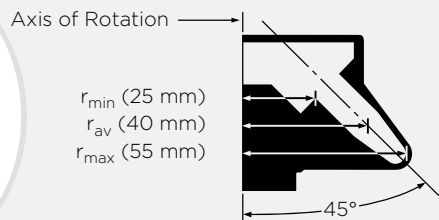

Fixed-Angle Rotor, Aluminum

For use in the TL-100, Optima TL, Optima TLX, Optima MAX-XP and Optima MAX-TL ultracentrifuges.

Major applications: Rapid pelleting of nucleic acid precipitates in 1.5 mL tubes

Max. RPM	Max. <i>g</i>	<i>k</i> Factor	Number of Tubes Volume/Size	Rotor Capacity
55 000	186 000	66	12 x 1.5 mL 11 x 38 mm	18 mL

No. 366725. TLA-55 Fixed-Angle Rotor Package. Includes BioCertified Rotor, 1 box 357448 Microcentrifuge Tubes, 1 each 824412 and 824644 O-rings, 348122 Tube Rack, 927208 Hemostats, 306812 Spinkote Lubricant and 335148 Vacuum Grease.

No. 366720. TLA-55 Rotor assembly.

Tubes and Bottles									
Tube Style/ Material	Vol. (mL) g-Max	Part No.	Quantity	Size (mm)	Required Caps/ Spacers (qty. 1)	Required Adapters (qty. 1)	<i>g</i> -Force	<i>k</i> Factor	Max. Speed
Microcentrifuge Polypropylene	1.5	357448	500	11 x 38	-	-	186 000	66	55 000

Rotor Accessories

347404	Rotor Cleaning Brush
348122	Tube Rack
927208	Hemostats, 6-in curved

Rotor Replacement Parts

349318	Cap & Plunger Assembly
366722	Rotor Lid Assembly
824412	O-ring (Inner, Rotor Lid)
824644	O-ring (Outer, Rotor Lid)
361668	Tube Removal Tool
306812	Spinkote Lubricant
335148	Silicone Vacuum Grease (1 oz)
339558	Rotor Cleaning kit
339555	Beckman Solution 555

≈ This rotor has been tested to demonstrate containment of microbiological aerosols only while operating within the associated Beckman Coulter centrifuge.

1. Analytical UC
2. Floor Prep UC
3. Tabletop UC
4. Micro-UC
5. Tubes
6. Accessories
7. Reference
8. Support

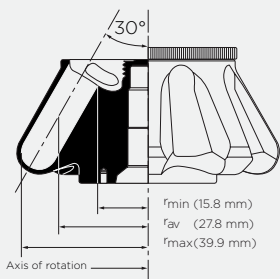

Fixed-Angle Rotor, Titanium

For use in the Optima MAX-XP ultracentrifuge.

Major applications: Rapid differential sedimentation (pelleting) of small particles such as subcellular organelles and viruses.

Max. RPM	Max. g	k Factor	Number of Tubes Volume/Size	Rotor Capacity
150 000	989 000	10.4*	8 x 2.0 mL 11 x 32 mm	16 mL

* Based on cell hole dimensions. k-Factor = 4.58 if run with 1 mL sample and open top tube.

No. 393490. MLA-150 Rotor Package. Includes Rotor, 1 box 344625 Quick-Seal Polypropylene Tubes, 1 each 393570 (pkg of 8) Spacers, 349387 Tube Rack, 860218 O-ring, 927208 Hemostats, 306812 Spinkote Lubricant, and 335148 Vacuum Grease.

No. 393489. MLA-150 Fixed-Angle Rotor Assembly.

Tubes and Bottles									
Tube Style/ Material	Vol. (mL)	Part No.	Quantity	Size (mm)	Required Caps / Spacers (qty. 8)	Adapters (qty. 1)	g-Force	k Factor	Max. Speed
Quick-Seal Polypropylene	1.5	344624	50	11 x 25	393570	-	989 000	6.2	150 000
	2.0	344625	50	11 x 32	393570	-	989 000	8.0	150 000
Thickwall Polypropylene	1.0	347287	100	11 x 34	-	-	387 000	11.4	95 000
Thickwall Polycarbonate	1.0	343778	100	11 x 34	-	-	964 000	4.6	150 000

Rotor Accessories	
306812	SSpinkote Lubricant (2 oz)
335148	Silicone Vacuum Grease
339555	Beckman Solution 555 (1 qt)
339558	Rotor Cleaning Kit
342025	Fraction Recovery System
347404	Rotor Cleaning Brush
347828	Fraction Recovery System Adapter Kit for TL-series tubes
349387	Tube Topper Rack
358312	Quick-Seal Cordless Tube Topper Kit, 60 Hz
358313	Quick-Seal Cordless Tube Topper Kit, 50 Hz (Europe)
358314	Quick-Seal Cordless Tube Topper Kit, 50 Hz (Great Britain)
358315	Quick-Seal Cordless Tube Topper Kit, 50 Hz (Australia)
361668	Tube Removal Tool
927208	Hemostat, 6 in. curved
961519	Hemostat, 6 in. straight

Rotor Replacements Parts	
393485	Rotor Lid Assembly
860218	O-ring for Lid

Adapters/Spacers
393570



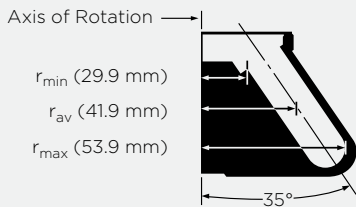

Fixed-Angle Rotor, Titanium

For use in the Optima MAX-XP ultracentrifuge.

Major applications: Rapid differential sedimentation (pelleting) of small particles such as subcellular organelles and viruses

Max. RPM	Max. <i>g</i>	<i>k</i> Factor	Number of Tubes Volume/Size	Rotor Capacity
130 000	1 019 000	8.7	10 x 2.0 mL 11 x 32 mm	20 mL

No. 367114. MLA-130 Fixed-Angle Rotor Package. Includes Rotor, 1 box 344625 Quick-Seal Polypropylene Tubes, 10 each 367310 Spacers, 1 each 349387 Tube Rack, 975001 O-ring, 927208 Hemostats, 306812 Spinkote Lubricant, and 335148 Vacuum Grease.

Tubes and Bottles									
Tube Style/ Material	Vol. (mL)	Part No.	Quantity	Size (mm)	Floating Spacers (qty. 1)	Adapters (qty. 1)	<i>g</i> -Force	<i>k</i> Factor	Max. Speed
Quick-Seal Polypropylene	1.5	344624	50	11 x 25	367310	-	1 019 000	7.0	130 000
	2.0	344625	50	11 x 32	367310	-	1 019 000	8.7	130 000
Thickwall Polypropylene	1.0	347287	100	11 x 34	-	-	390 000	23	80 000
Thickwall Polycarbonate	1.0	343778	100	11 x 34	-	-	1 019 000	5.8	130 000

Rotor Accessories		Rotor Replacements Parts	
306812	Spinkote Lubricant (2 oz)	347373	Rotor Vise
335148	Silicone Vacuum Grease	367115	Rotor Lid
339555	Beckman Solution 555 (1 qt)	975001	O-ring for Lid
339558	Rotor Cleaning Kit		
342025	Fraction Recovery System		
347404	Rotor Cleaning Brush		
347828	Fraction Recovery System Adapter Kit for TL-series tubes		
349387	Tube Topper Rack		
358312	Quick-Seal Cordless Tube Topper Kit, 60 Hz		
358313	Quick-Seal Cordless Tube Topper Kit, 50 Hz (Europe)		
358314	Quick-Seal Cordless Tube Topper Kit, 50 Hz (Great Britain)		
358315	Quick-Seal Cordless Tube Topper Kit, 50 Hz (Australia)		
361668	Tube Removal Tool		
927208	Hemostat, 6-in. curved		
961519	Hemostat, 6-in. straight		
367803	Quick-Seal Cordless Tube Topper Kit, 60 Hz (Canada)		

Adapters/Spacers
367310



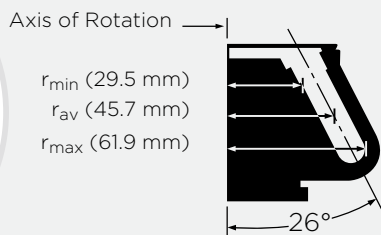

Fixed-Angle Rotor, Titanium

For use in the Optima MAX-XP ultracentrifuge.

Major applications: Large volume differential sedimentation (pelleting) of subcellular organelles and viruses.

Max. RPM	Max. <i>g</i>	<i>k</i> Factor	Number of Tubes Volume/Size	Rotor Capacity
80 000	444 000	29	8 x 8 mL 16 x 64 mm	64 mL

No. 367096. MLA-80 Fixed-Angle Rotor Package. Includes Rotor, 1 box 344621 Quick-Seal Polypropylene Tubes, 10 each 367094 Spacers, 1 each 348123 Tube Rack, 927208 Hemostats, 338765 Spacer Removal Tool, 306812 Spinkote Lubricant, and 335148 Vacuum Grease.

Tubes and Bottles									
Tube Style/ Material	Vol. (mL)	Part No.	Quantity	Size (mm)	Required Caps/ Spacers (qty. 1)	Required Adapters (qty. 1)	<i>g</i> -Force	<i>k</i> Factor	Max. Speed
Quick-Seal Polypropylene	4.2	356562	50	16 x 38	367094	-	444 000	18	80 000
	6.3	345830	50	16 x 45	367094	-	444 000	23	80 000
	8.0	344621	50	16 x 58	367094	-	444 000	29	80 000
Thickwall Polypropylene	5.8	355646	25	16 x 64	-	-	84 900	153	35 000
Thickwall Polycarbonate	5.8	355647	25	16 x 64	-	-	418 000	19	80 000

Rotor Accessories	
306812	Spinkote Lubricant (2 oz)
335148	Silicone Vacuum Grease
338765	Floating Spacer Removal Tool
339555	Beckman Solution 555 (1 qt)
339558	Rotor Cleaning Kit
347404	Rotor Cleaning Brush
348123	Tube Topper Rack
358312	Quick-Seal Cordless Tube Topper Kit, 60 Hz
358313	Quick-Seal Cordless Tube Topper Kit, 50 Hz (Europe)
358314	Quick-Seal Cordless Tube Topper Kit, 50 Hz (Great Britain)
358315	Quick-Seal Cordless Tube Topper Kit, 50 Hz (Australia)
361668	Tube Removal Tool
927208	Hemostat, 6-in. curved
961519	Hemostat, 6-in. straight
367803	Quick-Seal Cordless Tube Topper Kit, 60 Hz (Canada)

Rotor Replacements Parts	
346133	Rotor Vise
367089	Rotor Lid
892292	O-ring

Adapters/Spacers
367094



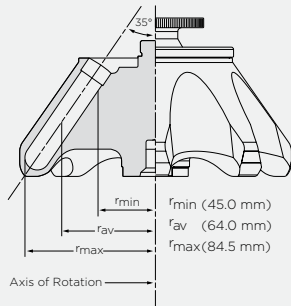

Fixed-Angle Rotor, Aluminum

For use in the Optima MAX-XP ultracentrifuge.

Major applications: Plasmid DNA Separations.

Max. RPM	Max. <i>g</i>	<i>k</i> Factor	Number of Tubes Volume/Size	Rotor Capacity
55 000	287 000	53	8 x 13.5 mL 16 x 76 mm	108 mL

No. A31459. MLA-55 Fixed-Angle Rotor Package. Includes Rotor, 4 boxes of OptiSeal Tubes 361623, 12 spacers 361670 (6 pkg. of 2), 1 OptiSeal Tube Rack 361642, 1 Tube Extraction Tool 361668, and 1 Spacer Removal Tool 338765.

No. 393203. MLA-55 Fixed-Angle Rotor Assembly.

No. 348179. Quick-Seal Tube Kit with 2 boxes 342413 Polypropylene Tubes, 2 boxes 344322 Ultra-Clear Tubes, 12 each 342695 Spacers, 1 each 348123 Tube Rack, 306812 Spinkote Lubricant, and 335148 Vacuum Grease. (Cordless Tube Topper Kit required; see Tools, Accessories, and Supplies.)

No. 348180. Open-Top Tube Kit with 2 boxes 326814 Polypropylene Tubes, 2 boxes 344085 Ultra-Clear Tubes, 12 each 341968 Tube Caps, 1 each 306812 Spinkote Lubricant, and 335148 Vacuum Grease. (331202 and 305075 Tools required; see Tools, Accessories, and Supplies.)

Tubes and Bottles									
Tube Style/ Material	Vol. (mL) <i>g</i> -Max	Part No.	Quantity	Size (mm)	Required Caps/ Spacers (qty. 1)	Required Adapters (qty. 1)	<i>g</i> -Force	<i>k</i> Factor	Max. Speed
OptiSeal Bell-Top	8.9	361623	56	16 x 60	361670 ^{§§}	-	289 996	52	55 000
Polycarbonate Bottle Assembly	10.4	355603	6	16 x 76	355604	-	288 658	67	55 000
Quick-Seal Polypropylene	4.2	356562	50	16 x 38	345828	-	289 335	28	55 000
	4.2	357332[§]	50	16 x 38	345828	-	289 335	28	55 000
	6.3	345830	50	16 x 45	345828	-	289 335	37	55 000
	6.3	357334[§]	50	16 x 45	345828	-	289 335	37	55 000
	10.0	344622	50	16 x 67	344676	-	289 335	60	55 000
	13.5	342413*	50	16 x 76	342695	-	289 335	77	55 000
Quick-Seal Ultra-Clear	13.5	344322	50	16 x 76	342695	-	289 674	74	55 000
Thickwall Polypropylene	4.0	355644	25	13 x 64	-	303313	214 200	52	50 000
	10.0	355640	25	16 x 76	338907	-	85 176	177	30 000
Thickwall Polycarbonate	4.0	355645	25	13 x 64	-	303313	214 200	52	50 000
	10.0	355630	25	16 x 76	338907	-	286 286	53	55 000
Thinwall Polypropylene	6.5	326820	50	16 x 64	346256	303313	215 880	56	50 000
	13.5	326814	50	16 x 76	341968	-	289 335	59	55 000
Ultra-Clear	3.0	344092	50	13 x 32	346256	-	133 585	37	45 000
	2.0	344091	50	8 x 49	303624	303376	143 718	80	40 000
	4.0	344093	50	13 x 41	346256	303402	145 379	53	45 000
	6.5	344088*	50	13 x 64	346256	303313	215 600	57	50 000
	13.5	344085	50	16 x 76	341968	-	291 029	61	55 000











Sterile and Certified-Free Tubes												
Tube Style/ Material	Vol. (mL) <i>g</i> -Max	Size (mm)	Beckman Standard Part Number	Certified Free Part Number	Qty	Sterile Part Number	Qty	Required Caps / Spacers (qty. 1)	Required Adapters (qty. 1)	<i>g</i> -Force	<i>k</i> Factor	Max. Speed
Ultra-Clear	6.5	13 x 64	344088	C14280	50	C14296	48	346256	303313	215 600	57	50 000
Polypropylene	13.5	16 x 76	342413	C14290	50	C14306	48	342695	-	289 335	77	55 000

Note: To help you locate *g*-Max tubes in the rotor listings, these tubes are highlighted with bold, italic type.

§§ To simplify ordering, this *g*-Max Kit includes enough spacers to fill rotor, 50 tubes and required tools.

§§ Set of 2.

* Sterile and C-Free options available.

Adapters/Spacers										
303313	303376	303402	303624	338907	341968	346256	342695	344676	345828	361670
										

Rotor Accessories	
301875	Tube Removal Tool
305075	Tube-Cap Vise
306812	Spinkote Lubricant (2 oz)
331202	Tool Kit for Aluminum Caps
	Includes:
	858121 Torque Wrench
	858122 Socket Adapter
	870432 Socket for 11-mm Hex Nuts
	301875 Removal Tool, for capped tubes
335148	Silicone Vacuum Grease
338765	Floating Spacer Removal Tool
339379	Rotor Cleaning Brush
339555	Beckman Solution 555 (1 qt)
339558	Rotor Cleaning Kit
348123	Tube Topper Rack
358312	Quick-Seal Cordless Tube Topper Kit, 60 Hz
358313	Quick-Seal Cordless Tube Topper Kit, 50 Hz (Europe)
358314	Quick-Seal Cordless Tube Topper Kit, 50 Hz (Great Britain)
358315	Quick-Seal Cordless Tube Topper Kit, 50 Hz (Australia)
361642	OptiSeal Tube Rack Assembly
361668	Tube Removal Tool for Quick-Seal and OptiSeal Tubes
841883	Hex Driver for 11-mm Cap Nuts on Stainless Steel Tubes

Rotor Replacements Parts	
347373	Rotor Vise
393206	Rotor Handle
393210	Rotor Lid
839347	Handle O-Ring (Small)
876089	Lid O-Ring (Large)

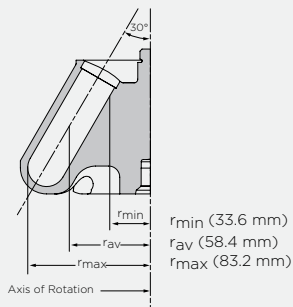

Fixed-Angle Rotor, Aluminum

For use in the Optima MAX-XP ultracentrifuge.

Major applications: Large volume separations of subcellular particles, viruses, lipoproteins, RNA, and plasmid DNA.

Max. RPM	Max. g	k Factor	Number of Tubes Volume/Size	Rotor Capacity
50 000	233 000	92	6 x 32.4 mL 25 x 77 mm	194.4 mL

No. A91774. MLA-50 Fixed-Angle Rotor Assembly.

Tubes and Bottles									
Tube Style/ Material	Vol. (mL)	Part No.	Quantity	Size (mm)	Required Caps/ Spacers (qty. 1)	Required Adapters (qty. 1)	Max RCF (x g)	k Factor	Max. Speed (rpm)
OptiSeal Polypropylene	29.9	361625	56	25 x 77	361669 ^{§§}	-	233 000	92	50 000
Quick-Seal Polypropylene	15.0	343664	50	25 x 38	343448	-	233 000	50	50 000
	15.0	357343^{§§}	50	25 x 38	343448	-	233 000	50	50 000
	27.0	343665	50	25 x 64	343448	-	233 000	79	50 000
	27.0	357346^{§§}	50	25 x 64	343448	-	233 000	79	50 000
Quick-Seal Ultra-Clear	15.0	344324	50	25 x 38	343448	-	233 000	50	50 000
	27.0	344323	50	25 x 64	343448	-	233 000	79	50 000
Thinwall Polypropylene	6.5	326820	50	13 x 64	346256	303392	189 000	76	50 000
	13.5	326814	50	16 x 76	330860	303307	209 000	94	50 000
Thickwall Polypropylene	4.0	355644	25	13 x 64	-	303392	187 000	52	50 000
	10.0	355640	25	16 x 76	338907	303307	206 000	89	50 000
Thickwall Polycarbonate	4.0	355645	25	13 x 64	-	303392	187 000	52	50 000
	10.0	355630	25	16 x 76	338907	303307	206 000	89	50 000

Note: To help you locate g-Max tubes in the rotor listings, these tubes are highlighted with bold, italic type.

§§ Set of 2.

§§ To simplify ordering, this g-Max Kit includes 50 tubes, 12 spacers, a spacer removal tool and forceps.

Rotor Accessories		Rotor Accessories	
306812	Spinkote Lubricant (2 oz)	A91766	Rotor Lid
841883	Hex Driver for 11-mm Cap Nuts on Stainless Steel Tubes	A92167	Lid O-Ring (Large)
331202	Tool Kit for Aluminum Caps	A96399	Rotor Handle
	Includes:	841884	Hex Driver (for 8mm cap nuts)
	301875 Removal Tool, for capped tubes	305075	Tube Cap Vise
	858121 Torque Wrench		
	858122 Socket Adapter		
	858123 Socket for 19 mm Hex Nut		
	870432 Socket for 11 mm Hex Nut		
335148	Silicone Vacuum Grease		
338765	Floating Spacer Removal Tool		
339379	Rotor Cleaning Brush		
339555	Beckman Solution 555 (1 qt)		
339558	Rotor Cleaning Kit		
348122	Tube Topper Rack		
348123	Tube Topper Rack		
348124	Quick-Seal Tube Topper Rack		
358312	Quick-Seal Cordless Tube Topper Kit, 60 Hz		
358313	Quick-Seal Cordless Tube Topper Kit, 50 Hz (Europe)		
358314	Quick-Seal Cordless Tube Topper Kit, 50 Hz (Great Britain)		
358315	Quick-Seal Cordless Tube Topper Kit, 50 Hz (Australia)		
361646	OptiSeal Tube Rack Assembly		
361668	Tube Removal Tool for Quick-Seal and OptiSeal Tubes		

Adapters/Spacers						
303307	303392	330860	338907	343448	346256	361669

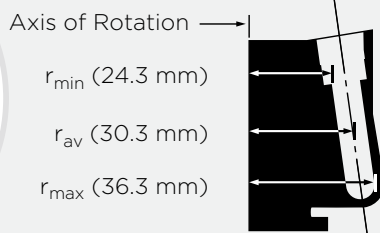

NVT Near-Vertical Rotor, Titanium

For use in the TL-100*, Optima TL, Optima TLX, Optima MAX-XP and Optima MAX-TL ultracentrifuges.

Note: Non-precipitating solutions up to 1.7 g/mL in density can be run in this rotor without a reduction in rotor speed.

Major applications: Plasmid DNA Separations in 1½ hours.**

Max. RPM	Max. g	k Factor	Number of Tubes Volume/Size	Rotor Capacity
120 000	585 000	7	8 x 1.2 mL 8 x 35 mm	9.6 mL

No. 357683. TLN-120 Near-Vertical Package. Includes Rotor, 1 box 361082 Quick-Seal Polypropylene Tubes, 10 each 361061 Spacers, 12 each 347371 Rotor Plug Gaskets, 1 each 348302 Tube Rack, 347373 Rotor Vise/Stand, 927208 Hemostats, 858121 Torque Wrench, 976959 Torx Wrench Adapter, and 306812 Spinkote Lubricant.

No. 361062. TLN-120 Rotor Assembly

Tubes and Bottles									
Tube Style/ Material	Vol. (mL)	Part No.	Quantity	Size (mm)	Required Caps/ Spacers (qty. 1)	Required Adapters (qty. 1)	g-Force	k Factor	Max. Speed
Quick-Seal Polypropylene	1.2	361082	50	8 x 35	361061	-	585 000	7	120 000

* To accommodate the TLN-120 Rotor, the TL-100 ultracentrifuge must be updated with a new drive spindle and operating software(modification kit number 360477).

** Using Optima MAX-XP, Optima MAX-TL or Optima TLX

Rotor Accessories		Rotor Replacements Parts	
306812	Spinkote Lubricant (2 oz)	347371	Rotor Plug Gasket
338765	Tube Removal Tool	347373	Rotor Vise
339555	Beckman Solution 555 (1 qt)	349339	Cap and Plunger Assembly
339558	Rotor Cleaning Kit	368549	Rotor Plug Replacement (each)
347402	Rotor Vise Mounting Tape (replacement)	976959	Torx Wrench Adapter
347404	Rotor Cleaning Brush	361061	Tube Spacers
347960	Centri-Tube Slicer	348302	Quick-Seal Tube Sealing Rack
348299	CentriTube Slicer Replacement Blades (pkg of 10)		
348304	Tube Rack, 8 mm		
349661	Quick-Seal Tube Sealing Rack		
354526	CentriTube Slicer Adapter for 13mm tubes		
358312	Quick-Seal Cordless Tube Topper Kit, 60 Hz		
358313	Quick-Seal Cordless Tube Topper Kit, 50 Hz (Europe)		
358314	Quick-Seal Cordless Tube Topper Kit, 50 Hz (Great Britain)		
358315	Quick-Seal Cordless Tube Topper Kit, 50 Hz (Australia)		
858121	Torque Wrench		
927208	Hemostat, 6 in. curved		
977305	Rotor Vise Mounting Screws (pkg of 4)		
367803	Quick-Seal Cordless Tube Topper Kit, 50 Hz (Canada)		
355872	Tube Topper Rack		

Adapters/Spacers
361061



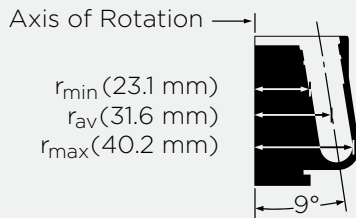

NVT Near-Vertical Rotor, Titanium

For use in the TL-100, Optima TL, Optima TLX, Optima MAX-XP and Optima MAX-TL ultracentrifuges.

Note: Non-precipitating solutions up to 1.7 g/mL in density can be run in this rotor without a reduction in rotor speed.

Major applications: Plasmid DNA-Separations in 4 hours.

Max. RPM	Max. g	k Factor	Number of Tubes Volume/Size	Rotor Capacity
100 000	450 000	14	8 x 3.9 mL 13 x 38 mm	31.2 mL

No. 357614. TLN-100 Rotor Assembly

Tubes and Bottles									
Tube Style/ Material	Vol. (mL) g-Max	Part No.	Quantity	Size (mm)	Required Caps/ Spacers (qty. 1)	Required Adapters (qty. 1)	g-Force	k Factor	Max. Speed
OptiSeal Polypropylene	3.3	361627	56	13 x 33	362198	-	450 000	14	100 000
Quick-Seal Polypropylene	3.9	358980	50	13 x 38	342883	-	450 000	14	100 000

Rotor Accessories	
306812	Spinkote Lubricant (2 oz)
335148	Silicone Vacuum Grease (1 oz)
338765	Tube Removal Tool
339555	Beckman Solution 555 (1 qt)
339558	Rotor Cleaning Kit
342025	Fraction Recovery System
342883	Quick-Seal Tube Spacer (pkg/8)
347404	Rotor Cleaning Brush
347828	Fraction Recovery System Adapter Kit for TL-series tubes
347960	CentriTube Slicer
348122	Tube Topper Rack, 13 mm
348299	CentriTube Slicer Replacement Blades (pkg of 10)
354526	CentriTube Slicer Adapter for 13 mm tubes
355872	Tube Rack, 13 mm
358312	Quick-Seal Cordless Tube Topper Kit, 60 Hz
358313	Quick-Seal Cordless Tube Topper Kit, 50 Hz (Europe)
358314	Quick-Seal Cordless Tube Topper Kit, 50 Hz (Great Britain)
358315	Quick-Seal Cordless Tube Topper Kit, 50 Hz (Australia)
361650	OptiSeal Tube Rack Assembly
361668	Tube Removal Tool
858121	Torque Wrench
927208	Hemostat, 6 in curved
961519	Hemostat, 6 in. straight
367803	Quick-Seal Cordless Tube Topper Kit, 50 Hz (Canada)
358121	Torque Wrench

Rotor Replacements Parts	
342882	Rotor Plug Gasket
347373	Rotor Vise
347402	Rotor Vise Mounting Tape (replacement)
349339	Cap and Plunger Assembly
368545	Rotor Replacement Plug (single)
368546	Rotor Replacement Plugs with Gaskets (set of 8)
976959	Torx Wrench Adapter

Adapters/Spacers	
342883	362198



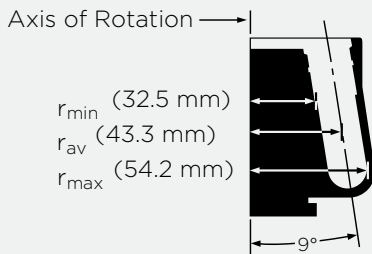

Near-Vertical Tube Rotor, Titanium

For use in the Optima MAX-XP ultracentrifuge..

Major applications: Rapid contamination-free isopycnic isolation of plasmid DNA.

Max. RPM	Max. <i>g</i>	<i>k</i> Factor	Number of Tubes Volume/Size	Rotor Capacity
80 000	389 000	20	8 x 8 mL 16 x 58 mm	64 mL

No. 367100. MLN-80 Near-Vertical Tube Rotor Package. Includes Rotor, 1 box 344621 Quick-Seal Polypropylene Tubes, 10 each 367101 Spacers, 2 each 392083 Plug and Cell, 349290 Washer and Plug, 1 each 348123 Tube Rack, 347373 Rotor Vise/Stand, 927208 Hemostats, 858121 Torque Wrench, 976959 Torx Wrench Adapter, 338765 Spacer Removal Tool, 306812 Spinkote Lubricant, and 335148 Vacuum Grease.

Tubes and Bottles									
Tube Style/ Material	Vol. (mL)	Part No.	Quantity	Size (mm)	Required Caps/ Spacers (qty. 1)	Required Adapters (qty. 1)	<i>g</i> -Force	<i>k</i> Factor	Max. Speed
Quick-Seal Polypropylene	4.2	356562	50	16 x 38	349289 367312	-	389 000	16	80 000
	6.3	345830	50	16 x 45	349289 367313	-	389 000	18	80 000
	8.0	344621	50	16 x 58	367101	-	389 000	20	80 000

Rotor Accessories	
306812	Spinkote Lubricant (2 oz)
335148	Silicone Vacuum Grease (1 oz)
338765	Floating Spacer Removal Tool
339379	Rotor Cleaning Brush
339555	Beckman Solution 555 (1 qt)
339558	Rotor Cleaning Kit
348123	Tube Topper Rack, 16 mm
358312	Quick-Seal Cordless Tube Topper Kit, 60 Hz
358313	Quick-Seal Cordless Tube Topper Kit, 50 Hz (Europe)
358314	Quick-Seal Cordless Tube Topper Kit, 50 Hz (Great Britain)
358315	Quick-Seal Cordless Tube Topper Kit, 50 Hz (Australia)
361668	Tube Removal Tool
858121	Torque Wrench
367803	Quick-Seal Cordless Tube Topper Kit, 50 Hz (Canada)

Rotor Replacements Parts	
347373	Rotor Vise Assembly
349290	Rotor Plug Gasket
392083	Plug, Cell
976959	Torx Wrench Adapter

Adapters/Spacers			
349289	367101	367312	367313

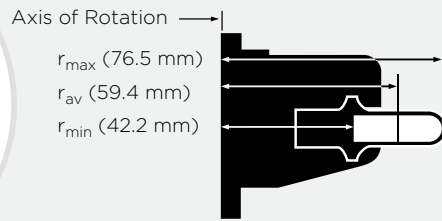

Swinging-Bucket Rotor, Titanium

For use in the TL-100, Optima TL, Optima TLX, Optima MAX-XPand Optima MAX-TL ultracentrifuges.

Note: Non-precipitating solutions up to 1.7 g/mL in density can be run in this rotor without a reduction in rotor speed.

Major applications: RNA pelleting in 2-3 hours; subcellular fractionation in sucrose gradients, protein separations in sucrose gradients..

Max. RPM	Max. g	k Factor	Number of Tubes Volume/Size	Rotor Capacity
55 000	259 000	50	4 x 2.2mL 11 x 34 mm	8.8 mL

No. 346936. TLS-55 Swinging-Bucket Rotor Assembly with 4 Titanium Buckets.

No. 346134. TLS-55 Swinging-Bucket Rotor Package. Includes Bio-Certified Rotor, 1 box 347357 Polypropylene Tubes, 1 each 348305 Tube Rack, 347358 Bucket Holder Rack, 927208 Hemostats, 868638 O-ring, 306812 Spinkote Lubricant, and 335148 Vacuum Grease.

Tubes and Bottles									
Tube Style/ Material	Vol. (mL) g-Max	Part No.	Quantity	Size (mm)	Required Caps/ Spacers (qty. 1)	Required Adapters (qty. 1)	g-Force	k Factor	Max. Speed
Quick-Seal Polypropylene	1.5 2	344624	50	11 x 25	344674	-	259 000	37	55 000
		344625	50	13 x 32	344674	-	259 000	50	55 000
Thinwall Polypropylene	175 µL 2.2	342630	100	5 x 20	-	358614	248 000	22	55 000
		347357	50	11 x 34	-	-	259 000	50	55 000
Thickwall Polypropylene	1.4	347287	100	11 x 34	-	-	259 000	50	55 000
Thickwall Polycarbonate	230 µL 1.4	343775	100	7 x 20	-	358615	249 000	23	55 000
		343778	100	11 x 34	-	-	259 000	50	55 000
Thickwall Cellulose Propionate	230 µL	342303	100	7 x 20	-	358615	249 000	23	55 000
Thickwall Polyethylene	175 µL	343622	100	5 x 20	-	358614	248 000	22	55 000
Ultra-Clear	2.2	347356	50	11 x 34	-	-	259 000	50	55 000

Rotor Accessories	
306812	Spinkote Lubricant (2 oz)
335148	Silicone Vacuum Grease (1 oz)
338765	Floating Spacer Removal Tool
339379	Rotor Cleaning Brush
339555	Beckman Solution 555 (1qt)
339558	Rotor Cleaning Kit
347404	Rotor Cleaning Brush
347828	Fraction Recovery System Adapter Kit for TL-series tubes
347960	CentriTube Slicer
348299	CentriTube Slicer Replacement Blades (pkg of 10)
348305	Tube Rack for 11-mm Tubes (included with Rotor Package)
358312	Quick-Seal Cordless Tube Topper Kit, 60 Hz
358313	Quick-Seal Cordless Tube Topper Kit, 50 Hz (Europe)
358314	Quick-Seal Cordless Tube Topper Kit, 50 Hz (Great Britain)
358315	Quick-Seal Cordless Tube Topper Kit, 50 Hz (Australia)
361668	Quick-Seal Tube Removal Tool
367803	Quick-Seal Cordless Tube Topper Kit, 50 Hz (Canada)
349387	Tube Rack 7/16 Tube / 24 Place

Rotor Accessories	
362100	Tube Rack Adapters, set/8, for 344624 11 x 25 mm Quick-Seal Tubes ^W
362101	Tube Rack Adapters, set/8, for 344625 11 x 25 mm Quick-Seal Tubes ^W
927208	Hemostats, 6-in. curved

√ Required for obsolete Bench Quick Sealer

Rotor Replacements Parts	
345770	Bucket Cap Assembly (each)
345773	Rotor Stand
346364	Replacement Bucket Set, set of 4
347358	Bucket Holder Rack
349338	Cap & Plunger Assembly
868638	Bucket O-ring

Adapters/Spacers		
344674	358614	358615

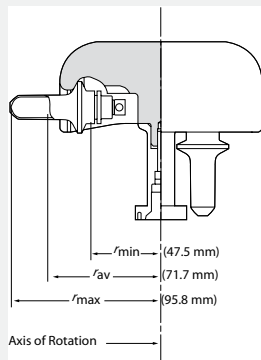

Swinging-Bucket Rotor, Aluminum

For use in the Optima MAX-XP ultracentrifuge.

Major applications: Rate-zonal separations of subcellular organelles, pelleting and isopycnic separations of RNA.

Max. RPM	Max. g	k Factor	Number of Tubes Volume/Size	Rotor Capacity
50 000	268 000	71	4 x 5 mL 13 x 51 mm	20 mL

No. 367280. MLS-50 Swinging-Bucket Rotor Package. Includes Rotor, 1 box 326819 Polypropylene Tubes, 1 each 331313 Bucket Holder Rack, 927208 Hemostats, 824412 O-ring, 306812 Spinkote Lubricant, and 335148 Vacuum Grease.

Tubes and Bottles									
Tube Style/ Material	Vol. (mL)	Part No.	Quantity	Size (mm)	Required Caps / Spacers (qty. 1)	Adapters (qty. 1)	g-Force	k Factor	Max. Speed
OptiSeal Polypropylene	3.3	361627	56	13 x 33	361678 (pkg of 2)	-	268 000	42	50 000
Quick-Seal Polypropylene	2.0	345829	50	13 x 25	355535	-	268 000	29	50 000
Quick-Seal konical Polypropylene	3.2	358647	50	13 x 51	355535	358153 (pkg of 6)	262 000	67	50 000
Thinwall Polypropylene	5.0	326819	50	13 x 51	-	-	268 000	71	50 000
Thinwall konical Polypropylene	3.0	358119	50	13 x 51	-	358153 (pkg of 6)	262 000	67	50 000
Thickwall Polypropylene	3.5	349623	25	13 x 51	-	-	268 000	71	50 000
Thickwall Polycarbonate	3.5	349622	25	13 x 51	-	-	268 000	71	50 000
Ultra-Clear	0.8 5.0	344090 344057	50 50	5 x 41 13 x 51	- -	356860 -	218 000 268 000	67 71	46 000 50 000

Rotor Accessories	
306812	Spinkote Lubricant (2 oz)
331313	Bucket Rack
335148	Silicone Vacuum Grease (1 oz)
338765	Floating Spacer Removal Tool
339379	Rotor Cleaning Brush
339555	Beckman Solution 555 (1 qt)
339558	Rotor Cleaning Kit
347828	Fraction Recovery System Adapter Kit for TL-series tubes
347960	CentriTube Slicer
348122	Tube Topper Rack for 13 mm Tubes
348299	CentriTube Slicer Replacement Blades (pkg of 10)
354468	Conical Adapter Extractor Tool
358312	Quick-Seal Cordless Tube Topper Kit, 60 Hz
358313	Quick-Seal Cordless Tube Topper Kit, 50 Hz (Europe)
358314	Quick-Seal Cordless Tube Topper Kit, 50 Hz (Great Britain)
358315	Quick-Seal Cordless Tube Topper Kit, 50 Hz (Australia)
361638	OptiSeal Tube Rack, 13 mm
361668	Quick-Seal and OptiSeal Tube Removal Tool
367803	Quick-Seal Cordless Tube Topper Kit, 50 Hz (Canada)

Rotor Replacements Parts	
367278	Rotor Stand Assembly
367284	Bucket Set
367285	Bucket Cap
824412	O-ring

Adapters/Spacers			
355535	356860	358153	361678

Airfuge Air-Driven Micro-Ultracentrifuge



The unique Airfuge Air-Driven Micro-Ultracentrifuge from Beckman Coulter is a convenient, easy-to-use pelleting tool in research, clinical, and industrial laboratories. Efficient and simple to operate, the Airfuge has a line of general-purpose and special purpose rotors for a wide variety of small-volume applications.

The easy-to-operate centrifuge

- Reaches top speed in only 30 seconds
- Decelerates smoothly to keep sample contents separated
- Offers timed runs of up to five hours with hold position for longer runs
- Operates near ambient temperature

Enhanced versatility with a variety of rotors

- Batch rotor pellets particles from large samples
- Chylomicron Rotor achieves rapid clarification of lipemic blood samples
- Four fixed angle rotors generate the high speeds and forces necessary to perform a variety of tasks



Part Numbers	Airfuge
340400	60 Hz, 120 VAC
340401	50 Hz, 220 VAC
347854	60 Hz, 120 VAC with Digital Tachometer
347855	50 Hz, 220 VAC with Digital Tachometer

Not intended or validated for use in the diagnosis of disease or other conditions.



Specifications	
Maximum Speed	110 000 rpm
Maximum g-force (RCF x g)	199 000 x g (A 110 Rotor)
Speed Control	± 5 000 rpm of set speed
Imbalance Tolerance	Up to 10% of volume in opposite tubes
Drive Cooling	Air-cooled
Time Setting	0-300 minutes in five minute increments, HOLD for longer runs
Accel/Decel Rates	30-60 seconds/2.5-5.5 minutes
Heat Output	0.6 kW/h (1 800 Btu/h)
Dimensions	28.0 cm (11 in) W x 38.0 cm (15 in) D x 20.0 cm (8 in) H
Weight	10.4 kg (23 lb)
Voltage Requirements	60/50 Hz, 100 VAC 50 Hz, 220-240 VAC 60 Hz, 110 VAC

Quick-Reference Guide to Airfuge Rotors

Rotor	Max. RPM	Max. g	k Factor	No. of Tubes x Nominal Tube Volume (mL)	Nominal Rotor Capacity (mL)
A-110	110 000	199 000	9	6 x 180 µL	1 080 µL
A-100/30	92 000	167 000	19	6 x 240 µL	1 440 µL
A-100/18	95 000	148 000	12	6 x 175 µL	1 050 µL
A-95	95 000	178 000	19	4 x 450 µL	1 800 µL
ACR-90	90 000	122 000	45	NA	3.5 mL
Batch Rotor	90 000	132 000	55	NA	7 mL
EM-90	90 000	118 000	NA	6 x 100 µL	600 µL

A-110

6 x 180 µL

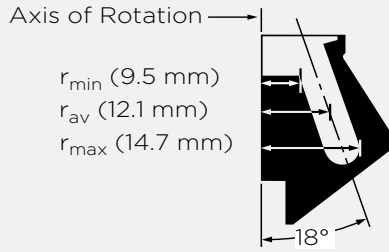
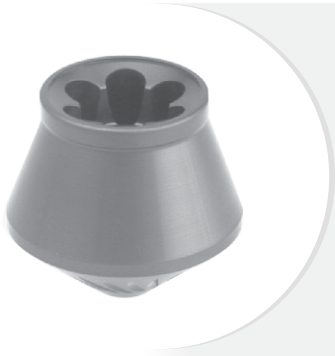

Fixed-Angle Rotor, Aluminum, Red

For use in the Airfuge Air-Driven Micro-Ultracentrifuge.
Major application: Fast pelleting of very small samples.

Max. RPM	Max. <i>g</i>	<i>k</i> Factor	Number of Tubes Volume/Size	Rotor Capacity
110 000	199 000	9	6 x 180 µL 5 x 20 mm	1080 µL

No. 347596. A-110 Rotor. Fixed-Angle Rotor with 18° angle, aluminum, anodized red. Includes 1 box of 342630 polypropylene tubes and 1 Tube Rack 348301.

Tubes and Bottles							
Tube Style/ Material	Usable Volume (µL)	Part No.	Quantity	Size (mm)	<i>g</i> -Force	<i>k</i> Factor	Max. Speed
Polypropylene	175	342630	100	5 x 20	199 000	9	110 000
Polyethylene	175	343622	100	5 x 20	199 000	9	110 000
Ultra-Clear	180	344718	100	5 x 20	199 000	9	110 000

Rotor Supplies	
339643	Rotor Caps, polyethylene, package of 20
348301	Tube Rack for 5-mm diameter Tubes
343773	Tube Cap Strip, 6-place, package of 50
339639	Rotor Base Bushing, white
341252	Rotor Stand/Vise

A-100/30

6 x 240 µL

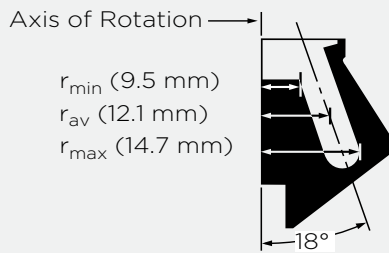

Fixed-Angle Rotor, Aluminum, Red

For use in the Airfuge Air-Driven Micro-Ultracentrifuge.
Major application: Fast pelleting of very small samples.

Max. RPM	Max. <i>g</i>	<i>k</i> Factor	Number of Tubes Volume/Size	Rotor Capacity
92 000	167 000	19	6 x 240 µL 5 x 20 mm	1 440 µL

No. 347594. A-100/30 Rotor. Fixed-Angle Rotor with 30° angle, anodized blue. Includes 1 box of 342630 Polypropylene Tubes and 1 Tube Rack 348301.

Tubes and Bottles							
Tube Style/ Material	Usable Volume (µL)	Part No.	Quantity	Size (mm)	<i>g</i> -Force	<i>k</i> Factor	Max. Speed
Polypropylene	220	342630	100	5 x 20	167 000	19	92 000
Polyethylene	150	343622	100	5 x 20	167 000	19	92 000
Ultra-Clear	240	344718	100	5 x 20	167 000	19	92 000

Rotor Supplies	
339643	Rotor Caps, polyethylene, package of 20
341252	Rotor Stand/Vise
343773	Tube Cap Strip, 6-place, package of 50
348301	Tube Rack for 5-mm diameter Tubes

A-100/18

6 x 175 µL

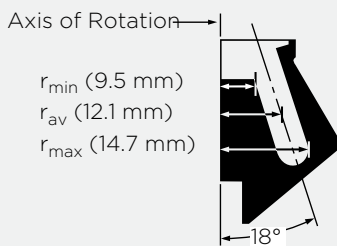

Fixed-Angle Rotor, Aluminum, Silver

For use in the Airfuge Air-Driven Micro-Ultracentrifuge.

Major application: Fast pelleting of very small samples.

Max. RPM	Max. <i>g</i>	<i>k</i> Factor	Number of Tubes Volume/Size	Rotor Capacity
95 000	148 000	12	6 x 175 µL 5 x 20 mm	1050 µL

No. 347593. A-100/18 Rotor. Fixed-Angle Rotor with 18° angle, aluminum, anodized silver. Includes 1 box of 342630 Polypropylene Tubes and 1 Tube Rack 348301.

Tubes and Bottles

Tube Style/ Material	Usable Volume (µL)	Part No.	Quantity	Size (mm)	<i>g</i> -Force	<i>k</i> Factor	Max. Speed
Polypropylene	175	342630	100	5 x 20	148 000	12	95 000
Polyethylene	100	343622	100	5 x 20	148 000	12	95 000
Ultra-Clear	175	344718	100	5 x 20	148 000	12	95 000

Rotor Supplies

339643	Rotor Caps, polyethylene, package of 20
348301	Tube Rack for 5-mm diameter tubes
343773	Tube Cap Strip, 6-place, package of 50
339639	Rotor Base Bushing, white
341252	Rotor Stand/Vise

A-95

4 x 450 µL

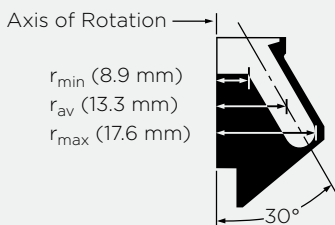

Fixed-Angle Rotor, Aluminum, Black

For use in Airfuge Air-Driven Micro-Ultracentrifuge.

Major application: Fast pelleting of very small samples.

Max. RPM	Max. <i>g</i>	<i>k</i> Factor	Number of Tubes Volume/Size	Rotor Capacity
95 000	178 000	19	4 x 450 µL 8 x 20 mm	1800 µL

No. 347595. A-95 Rotor. Fixed-Angle Rotor with 30° angle, aluminum, anodized black. Includes 1 box of 345843 Ultra-Clear Tubes and 1 Tube Rack 348302.

Tubes and Bottles

Tube Style/ Material	Usable Volume (µL)	Part No.	Quantity	Size (mm)	<i>g</i> -Force	<i>k</i> Factor	Max. Speed
Ultra-Clear	450	345843	100	8 x 20	178 000	19	95 000

Rotor Supplies

339643	Rotor Caps, polyethylene, package of 20
339639	Rotor Base Bushing, white
341252	Rotor Stand/Vise
343773	Tube Cap Strip, 6-place, package of 50
348302	Tube Rack for 8-mm diameter Tubes

ACR-90

3.5 mL/2.4 mL

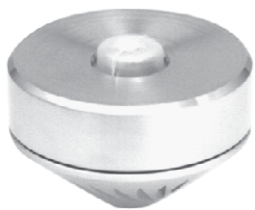

ACR-90 Chylomicron Rotor, Silver

For use in the Airfuge Air-Driven Micro-Ultracentrifuge.
Major application: Rapid clarification of lipemic blood samples.

Max. RPM	Max. g	k Factor	Liner Volume/Size	Rotor Capacity
90 000	122 000	45	3.5 mL	2.6
90,000	107 000	39	2.4 mL	1.4

No. 341260. ACR-90 Chylomicron Rotor, anodized aluminum. Consists of a Supporting Base, a Disposable Polyethylene Liner, and Stainless Steel Lid. Includes one 341252 Rotor Stand/Vise, one package 341251 Liners, Adapter for 342635 Liner.

Rotor Supplies

306812	Spinkote Lubricant
339639	Rotor Bushing, white
341251	Liner, polyethylene, 3.5 mL capacity, package of 100
341252	Rotor Stand/Vise
342634	Liner, polyethylene, 2.4 mL capacity, package of 100 (Adapter required)
342635	342635 Adapter for 342634 Liners, reusable
343779	Disposable Loading and Unloading Pipette, package of 500

Batch Rotor

7 mL

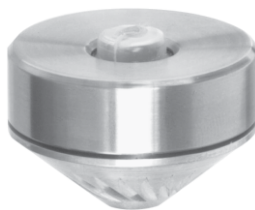

Batch Rotor, Aluminum, Silver

For use in the Airfuge Air-Driven Micro-Ultracentrifuge.
Major application: Rapid processing of fruit paste.

Max. RPM	Max. g	Minimum Fill Volume	Maximum Fill Volume	k Factor
90 000	132 000	2 mL	7 mL 8 at 2 mL	55 at 7 mL

No. 347833. Batch Rotor, aluminum, for 2 to 7 mL volumes. Sample is placed in the rotor body itself or in one of two types of polyethylene liners. A plastic window disk is placed between the rotor and the lid to contain samples during centrifugation. Includes 1 each 341252 Rotor Vise/Stand, 853156 O-ring, and 343197 Bushing.

Rotor Supplies

341252	Rotor Vise/Stand
343130	Shell Liner, polyethylene, large opening, 7 mL capacity, package of 100
343132	Dome Liner, polyethylene, small opening, 7 mL capacity, package of 100
343197	Bushing, red
347049	347049 Rotor Window Disk
853156	853156 Rotor O-ring



EM-90 Particle Counting Rotor, Silver

For use in the Airfuge Air-Driven Micro-Ultracentrifuge.

Major applications: Sedimenting particles onto filter membranes, glass cover slides, and microscope grids for electron microscopy.

Max. RPM	Max. g	Maximum Volume	Rotor Capacity
90 000	118 000	6 x 100 µL	600 µL

No. 347844. EM-90 Electron Microscopy Particle Counting Rotor. Includes 5-mm Core with 600 µL capacity (100 µL per cell); 3 mm Core with 360 µL capacity (60 µL per cell); one 341252 Rotor Stand/Vise, one 347840 (pkg of 5) Gaskets, Sector Core Removal Bolt, Template, one 853156 O-ring, one 343197 Bushing.

Rotor Supplies

343197	Bushing, red
347836	Sector Core, 5 mm
347838	Sector Core, 3 mm
347840	Rotor Gaskets, package of 5
347053	Core Cover
341252	Rotor Stand

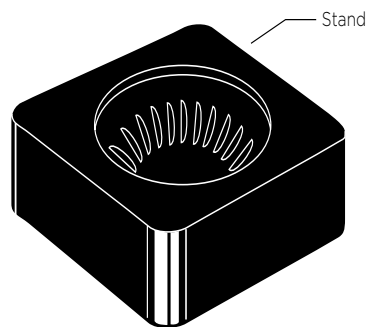
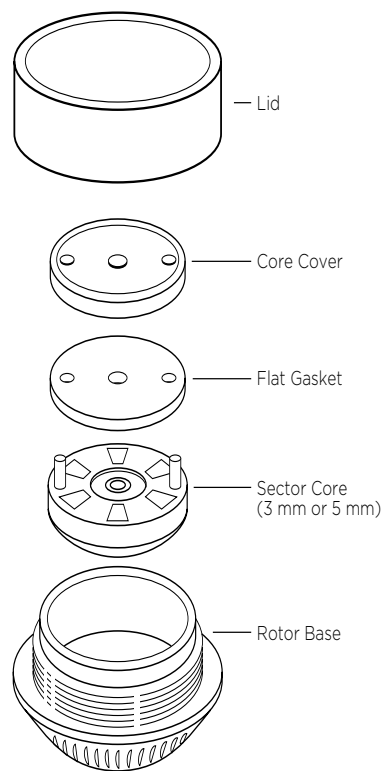

Tubes and Bottles For Every Application

No single tube design or material will meet all application requirements. A number of factors should be considered at the time a supply of tubes is ordered: the particular technique to be used, the nature of the sample and any solvent or gradient media, the desirability of reusing the tubes, and certain convenience factors. The properties listed below provide a guide for anyone involved in the tube selection process.

- Strength and Flexibility, to resist permanent deformation even when run in fixed angle rotors without tube caps.
- Chemical Resistance to a wide range of bases, acids, and solvents.
- Transparency, to permit a clear view of fractions and bands after centrifugation.
- Thin enough to be sliced or punctured after centrifugation for fraction collection.
- Impermeable to Water, to prevent aqueous solutions from permeating the tube wall and reaching the rotor cavity.
- Surface Properties that prevent the adherence of nucleic acids and proteins.
- Temperature Tolerance throughout a wide range of operating temperatures, without deforming at high temperatures or cracking when used close to 0°C.
- Autoclavable, for convenient sterilization and reuse.

The full line of Beckman Coulter tubes includes a number of tube materials, each with its own distinct combination of properties, to meet a variety of application requirements. Available are transparent, translucent, and opaque tubes, tubes that can be sliced or punctured, tubes that can be sterilized and reused, and tubes that are resistant to a variety of chemical compounds.

Tube Selection Considerations

Compatibility of Tube Material with Solvents and Sample

The chemical compatibility of the tube materials with the gradient-forming medium or other solvent is a prime consideration. Neutral sucrose and salt solutions cause no problem. But alkaline solutions, such as those frequently used for the separation of single-stranded forms of DNA, cannot be used in Ultra-Clear tubes or polycarbonate tubes and bottles. Sometimes DMSO is used in preparation of sucrose gradients for sedimentation of denatured RNA. Polycarbonate and Ultra-Clear tubes are incompatible with DMSO, so polypropylene tubes should be used.

The last column of the “Quick Reference Chart to Tube Materials and Their Properties” on page 2-4 gives some guidelines to the chemical resistances of the various tube materials. It must be emphasized, however, that other conditions of centrifugation (*g*-force, duration of run, etc.) have considerable effect on how well a tube material will withstand a particular solvent. Beckman Coulter publication IN-175, “Chemical Resistances for Beckman Coulter Centrifugation Products” (found on the Beckman Coulter web site at beckman.com/techdocs) provides more detailed information about the chemical resistances of the various tube materials. The wisest course is to test any questionable combination under operating conditions before making the actual run.

The type of sample, in some cases, will affect selection of a specific tube material. DNA, in its denatured or singlestranded form, will adhere to the surface of some tube materials. Polypropylene would be the best choice. (Most of this work is done in highly alkaline media which are incompatible with polycarbonate.)

Lipoprotein separations are most often done in Ultra-Clear tubes because they are clear and sliceable; these properties simplify fraction location and recovery by tube slicing. When small lipoprotein samples are to be recovered by a fractionating device and clear tubes are desirable, there are alternatives: cellulose propionate, polycarbonate, and Ultra-Clear tubes.

Hazardous materials, either pathogenic or radioactive, should be centrifuged with extreme care. All possible precautions must be taken to avoid leakage of the sample into the rotor cavity during centrifugation.

To determine the optimum tube material for your specific sample and gradient medium, refer to the quick reference chart on page 2-4.

Gradient Formation and Fractionation

When choosing a tube for a density gradient run, some thought should be given to gradient formation and fractionation. If the bands or zones formed during centrifugation are indistinct, they may not be visible through a translucent material such as polypropylene. If optimum band visualization is important, Ultra-Clear tubes or tubes of polycarbonate or cellulose propionate

should be used. Whenever collection of bands or zones must be done by puncturing the tube or slicing, a thin, flexible tube wall is required. Ultra-Clear or polypropylene tubes should be used, depending on the need for transparency.

As there are currently no wettable plastic centrifuge tubes available, gradients should be loaded into plastic tubes from the bottom up to avoid mixing.

High Temperature Centrifugation

Although modern centrifuges and rotors can operate at temperatures as high as 45°C, one cannot assume that every tube can be safely run over 25°C. Stainless steel and glass are the only materials which will not experience some deformation when subjected to high temperatures and long centrifugation times. Plastic tubes undergo some degree of softening at temperatures higher than 25°C. Whether or not this will cause permanent deformation is not a question of temperature alone. The centrifugal force field used, the duration of the centrifugation, the type of rotor, and even the tube angle all have an effect.

It's obviously impossible to give exact temperature limits for plastic tubes when so many other variables are involved. The safest policy is to pretest the tubes under the actual experimental conditions, but with water, rather than a valuable sample.

Tube Sizes

Tube sizes as indicated in the following charts are nominal sizes, and may vary somewhat from actual filling capacities. If a thick-walled tube is run uncapped, the maximum filling volume will depend on the tube angle of the rotor to be used. See appropriate rotor instruction manuals for maximum filling levels of tubes.

Tube Cleaning, Sterilization, and Reuse

If tubes are to be reused, special care must be taken during cleaning and sterilization. All tubes can be washed by hand with a mild detergent such as Solution 555 diluted 5-to-1 or 10-to-1 with water. This is particularly important for polycarbonate tubes and bottles which should not be exposed to a detergent with a pH higher than 8. Tubes and bottles should not be washed in commercial dishwashers as the detergents and high temperatures are too harsh. Solvents such as alcohol or acetone react unfavorably with many tube materials. If an organic solvent must be used in the cleaning procedure, consult bulletin IN-175 for a table of tube material/solvent compatibilities (or review the same document on the Beckman Coulter web site at beckman.com/techdocs).

The method chosen for sterilization has direct bearing on the number of reuses one can expect from a tube. Tubes and bottles of polypropylene, polyethylene, and glass can all be autoclaved, although in general, cold sterilization methods are not as harsh as autoclaving. Cold sterilization is recommended for both polycarbonate and Ultra-Clear. Do not dry tubes, bottles, or accessories in an oven. Labware should be air dried. OptiSeal, Quick-Seal, Ultra Clear, and thinwall polypropylene tubes are intended for one-time use and should be discarded after use.

1. Analytical UC
2. Floor Prep UC
3. Tabletop UC
4. Micro-UC
5. Tubes
6. Accessories
7. Reference
8. Support

TUBES AND BOTTLES

If maximum reuse is a major consideration, either polypropylene (preferably thick-walled) or polycarbonate tubes and bottles should be selected, and cold sterilization methods used. If these tubes are run completely filled in swinging bucket rotors, most of them can be reused a number of times. Chances of permanent deformation will be greater whenever the tubes are run in fixed angle rotors, without caps, and/or partially filled. All of these conditions tend to stress the centripetal edge of the tube unduly. All tubes that have been used or autoclaved previously must be individually examined for signs of deformation or cracking before using them again.

Tube Closures

When other considerations have been resolved, convenience may be a deciding factor. Without a doubt, the most convenient tube closure is none at all; none are required for tubes run in swinging bucket rotors and in the Airfuge Air-Drive Micro-Ultracentrifuge.

For tubes run in fixed angle rotors, alternatives to the standard tube cap assemblies are available. Bottles have three-piece cap assemblies which are easier to use than the more complex tube cap assemblies. Polycarbonate bottles are available for general-purpose fixed angle rotors, and are used frequently for differential centrifugation where band recovery is not a problem. Thickwall tubes can be run in all fixed angle rotors without caps, provided they are partially filled. (Refer to rotor manuals for more information on fill volumes.)

When closed tubes are required, Beckman Coulter offers some innovative and convenient options.

OptiSeal Tubes

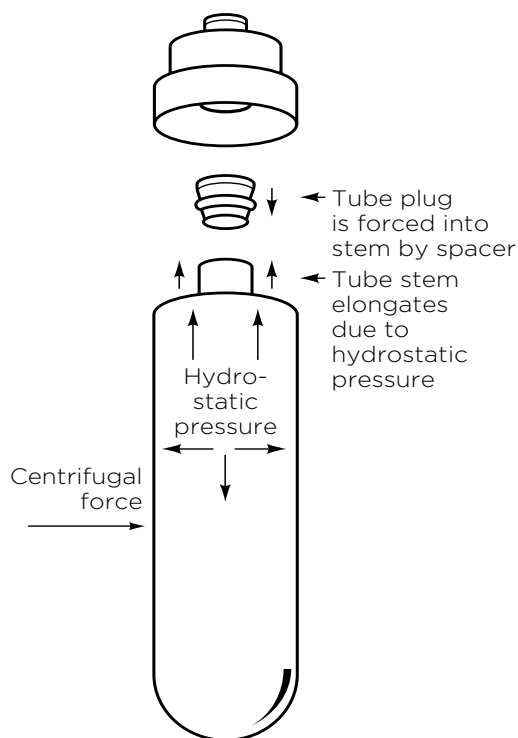

For virtually effortless sealing, OptiSeal tubes offer the best option. You simply insert the tube plug and press, and an O-ring seals securely against the tube's inner surface. During centrifugation, the combination of g -force and hydrostatic pressure ensures an effective seal. Engineered for reliability, there are no tools or mechanical parts to maintain. Finger pressure is all that is needed.

Quick-Seal Tubes

These tubes eliminate most of the steps involved in capping tubes and cut handling time in half. The top of the Quick-Seal tube is either dome-shaped or bell-shaped with a 3-mm-long inlet through which the tube is filled. The filled tube is heat-sealed using the hand-held sealer. The highly reliable seal achieved makes these tubes ideal for sample storage and for working with radioactive or pathogenic samples.

There are two Quick-Seal tube designs—dome-top and bell-top. The bell-top simplifies removal of materials that float upon centrifugation. The dome-top tubes hold more volume than their bell-top equivalents.

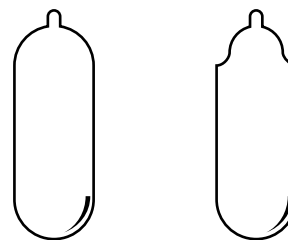

Dome-top Tubes Bell-top Tubes

TUBES AND BOTTLES

A Quick-Reference Chart to Tube Materials and Their Properties

Property	Thinwall Polypropylene	Thickwall Polypropylene	Ultra-Clear	Polycarbonate	Polypropylene	Polyethylene	Cellulose Propionate
Optical	transparent	translucent	transparent	transparent	translucent	transparent/translucent	transparent
Autoclaveable	yes	yes	no	no	yes	no	no
Puncturable	yes	no	yes	no	no	yes	no
Sliceable	yes	no*	yes	no*	no	no	no*
Reusable	no	yes	no	yes	yes	yes	no
Acids (dilute or weak)	S	S	S	S	S	S	S
Acids (strong)	U	S	U	U	S	S	U
Alcohols (aliphatic)	U	S	U	U	S	S	U
Aldehydes	M	M	S	M	M	S	U
Bases	S	S	U	U	S	S	U
Esters	U	M	U	U	M	S	M
Hydrocarbons (aliphatic)	U	M	U	U	S	U	S
Hydrocarbons (aromatic and halogenated)	U	U	U	U	M	M	S
Ketones	U	M	U	U	M	M	U
Oxidizing Agents (strong)	U	U	U	M	M	M	M
Salts	S	S	M	M	S	S	S

S = satisfactory resistance M = marginal resistance U = unsatisfactory resistance

Note: This information has been consolidated from a number of sources and is provided only as a guide to the selection of tube materials. Soak tests at 1 g (at 20°C) established the data for most of the materials; reactions may vary under the stress of centrifugation, or with extended contact or temperature variations. To prevent failure and loss of valuable sample, ALWAYS TEST SOLUTIONS UNDER OPERATING CONDITIONS BEFORE USE.

* Polypropylene, polycarbonate, and cellulose propionate tubes with diameters of 5 to 13 mm may be sliced using the CentriTube Slicer (part number 347960) and appropriate adapter plate.
Warning: Do not use flammable substances in or near an operating centrifuge.

General Filling and Sealing Requirements for Tubes and Bottles

	Tube or Bottle	Swinging-Bucket Rotors	Fixed-Angle Rotors
Polypropylene	Thinwall tubes	Within 2 to 3 mm of top	Full with cap
	Thickwall tubes	At least 1/2 full	1/2 full to max. capless level or full with cap
	Quick-Seal tubes	Full and heat-sealed	Full and heat-sealed
	Bottles	Min. to max. (see rotor manual) with screw-on cap or cap assembly	1/2 full to max. (see rotor manual) with screw-on cap assembly
Ultra-Clear	Open-top tubes	Within 2 to 3 mm of top	Full with cap
	Quick-Seal tubes	Not used	Full and heat-sealed
Polycarbonate	Thickwall tubes	At least 1/2 full	1/2 full capless level or full with cap or cap assembly
	Bottles	At least 1/2 full	Min. to max. (see rotor manual) with screw-on cap or cap assembly
Stainless Steel	Tubes	Any level	Any level with cap or cap assembly
Polyethylene	Tubes	At least 1/2 full	1/2 to max. capless level or full with cap or cap assembly
Telon	Tubes and bottles	At least 1/2 full	1/2 full to max. capless level or full with cap
Radel	Container	At least 1/2 full	N/A

Sterile and Certified Free Tubes

Whether you are helping to solve complex biological problems, investigating the causes of diseases or finding potential new cures, protecting your sample from degradation and contamination during your study is paramount. Sample protection when it matters most.



Certified Free

Certified Free tubes exhibit no detectable DNA, DNase, RNase, PCR inhibitors, or endotoxins.*

Ideal for Genomics, Exosomes, and Proteomics workflows

- Prevents sample degradation and contamination
- Double-bagged to prevent contamination during cleanroom transfer
- Improve QC data quality
- Certificates available on beckman.com

*Based on sample results below detectable limits.

Certified Free + Sterile

Beckman sterile ultracentrifuge tubes are sterilized via ethylene oxide.

Ideal for Protein Prep and Virus Purification workflows

- Includes all advantages of being certified free
- Pre-sterilized ready-to-use for improved workflow efficiency
- Eliminate need for developing sterilization protocol
- Packaged in workflow-based quantities
- Sterilized and packaged compliant with ISO 11135 and 11607
- Certificates available on beckman.com

Selection Guide

Tube type	Nominal Capacity (mL)	Nominal size (mm)	Beckman Standard	Certified Free	Certified Free + Sterile	Compatible rotors
Ultra-clear Open-top Round Bottom	38.5	25x89	344058	C13926	C14292	Type 70 Ti, Type 50.2 Ti, SW 32 Ti, SW 28, JS-24.38
	17	16x102	344061	C14281	C14297	SW 32.1 Ti, SW 28.1
	14	14x95	344060	C14278	C14294	SW 40 Ti
	13.2	14x89	344059	C14277	C14293	SW 41 Ti
	6.5	13x64	344088	C14280	C14296	Type 90 Ti, Type 70.1 Ti, Type 70 Ti, Type 50.4 Ti, Type 50.2 Ti, Type 45 Ti, MLA-55
	5	13x51	344057	C14279	C14295	SW 55 Ti
Ultra-clear Quick Seal Round Bottom	4	11x60	344062	C14282	C14298	SW 60 Ti
Ultra-clear Quick Seal Round Bottom	39	25x89	344326	C14283	C14299	Type 70 Ti, Type 50.2 Ti, VTi 50
	38.5	25x89	326823	C14285	C14301	Type 70 Ti, 50.2 Ti, SW 32 Ti, SW 28, JS-24.38
Polypropylene Open-top Round Bottom	14	14x95	331374	C14287	C14303	SW 40 Ti
	13.2	14x89	331372	C14286	C14302	SW 41 Ti
	4	11x60	328874	C18669	C18674	SW 60 Ti
Polypropylene Quick Seal Round Bottom	100	38x102	345776	C14289	C14305	Type 45 Ti, JA-18
	39	25x89	342414	C14288	C14304	Type 70 Ti, Type 50.2 Ti, VTi 50
	13.5	16x76	342413	C14290	C14306	Type 90 Ti, Type 70.1 Ti, NVT 65, VTi 65.1, MLA-55
Polypropylene Open-top konical	30	25x89	358126	C14291	C14307	SW 32 Ti, SW 28, JS-24.38

TUBES AND BOTTLES

Nominal Filling Capacity (mL)	Nominal Size (mm)	Part No.	Rotors See specific rotor pages for required spacers/adapters/accessories
OptiSeal Polypropylene Tubes			
3.3	13 x 33	361627	SW-55 Ti, SW-50.1, TLN-100, MLS-50
4.7	13 x 48	361621	Types 50.4 Ti, 50.3 Ti, TLA-110, TLA-100.4
4.9	13 x 51	362185	VTi 90, VTi 65.2, NVT 90, NVT 65.2
8.9	16 x 60	361623	Types 90 Ti, 80 Ti, 70.1 Ti, 65, 50 Ti, 50, MLA-55
11.2	16 x 70	362181	VTi 65.1, NVT 65
32.4	25 x 77	361625	Types 70 Ti, 60 Ti, 55.2 Ti, 50.2 Ti, 42.1, 30, SW 32 Ti, SW 28, MLA-50
36.2	25 x 89	362183	VTi 50
Quick-Seal Polypropylene Tubes			
1.0	8 x 51	345831	Type 25
1.2	8 x 35	361082	TLN-120
1.5	11 x 25	344624	SW 60 Ti, TLA-120.2, TLA-100.2, MLA-130, MLA-150, TLS-55
2.0	11 x 32	344625	SW 60 Ti, TLA-120.2, TLA-100.2, MLA-130, MLA-150, TLS-55
2.0	13 x 25	345829	Types 100 Ti, 50.4 Ti, 50.3, NVT 100, NVT 90, NVT 65.2, VTi 90, VTi 65.2, SW 55 Ti, SW 50, TLA-110, TLA-100.4, TLA-100.3, MLS-50
3.5	13 x 32	349621	Types 100 Ti, TLA-110, TLA-100.3
3.5	14 x 25	355870	SW 41 Ti, SW 40 Ti
3.9	13 x 38	358980	TLN-100
4.2	16 x 32	356562	Types 90 Ti, 80 Ti, 70.1 Ti, 65, 50 Ti, 40, SW 30.1, SW 32.1 Ti, SW 28.1, MLA-80, MLN-80, MLA-55
5.1	13 x 51	342412	VTi 90, VTi 65.2, NVT 100, NVT 90, NVT 65.2
5.1	13 x 51	362248	Type 100 Ti, TLA-110
5.9	14 x 47	355537	SW 41 Ti, SW 40 Ti
6.0	13 x 64	344619	Types 100 Ti, 50.4 Ti, 50.3 Ti
6.3	16 x 45	345830	Types 90 Ti, 80 Ti, 70.1 Ti, 65, 50 Ti, 50, 40, NVT 65, VTi 65.1, SW 30.1, SW 32.1 Ti, SW 28.1, MLA-80, MLN-80, MLA-55
8.0	16 x 58	344621	Type 50, NVT 65, VTi 65.1, SW 32.1 Ti, SW-28.1, MLA-80, MLN-80
10.0	16 x 67	344622	Types 90 Ti, 80 Ti, 70.1 Ti, 65, 50 Ti, 40, NVT 65, VTi 65.1, SW 32.1 Ti, SW 28.1, MLA-55
13.5	16 x 76	342413*	Types 90 Ti, 80 Ti, 70.1 Ti, 65, 50 Ti, 40, NVT 65, VTi 65.1, MLA-55
15.0	25 x 38	343664	Types 70 Ti, 60 Ti, 55.2 Ti, 50.2 Ti, VTi 50, SW 30, SW 32 Ti, SW 28, MLA-50
17.0	16 x 102	356291	SW 32.1 Ti, SW 28.1
27.0	25 x 64	343665	Types 70 Ti, 60 Ti, 55.2 Ti, 50.2 Ti, 42.1, VTi 50, SW 32 Ti, SW 28, MLA-50
33.0	25 x 83	344623	Types 70 Ti, 60 Ti, 55.2 Ti, 50.2 Ti, SW 32 Ti, SW 28
39.0	25 x 89	342414*	Types 70 Ti, 60 Ti, 55.2 Ti, 50.2 Ti, VTi 50
100.0	38 x 102	345776*	Type 45 Ti
Quick-Seal Polypropylene konical Tubes			
1.3	11 x 35	358655	SW 60 Ti
3.0	11 x 60	358648	SW 60 Ti
3.2	13 x 51	358647	SW 55 Ti, SW 50.1 Ti, MLS-50
4.0	14 x 48	358650	SW 41 Ti, SW 40 Ti
8.0	14 x 89	358649	SW 41 Ti, SW 40 Ti
8.5	25 x 38	358652	SW 30, SW 32 Ti, SW 28
12.5	16 x 102	358653	SW 32.1 Ti, SW 28.1
23.0	25 x 76	358654	SW 32 Ti, SW 28
28.0	25 x 83	358651	SW 32 Ti, SW 32 Ti, SW 28
Quick-Seal Ultra-Clear Tubes			
5.1	13 x 51	344075	NVT 90, NVT 65.2, VTi 90, VTi 65.2
6.0	13 x 64	344320	Types 50.4 Ti, 50.3 Ti
13.5	16 x 76	344322	Types 90 Ti, 80 Ti, 70.1 Ti, 65, 50 Ti, 40, NVT 65, VTi 65.1, MLA-55

* Sterile and Certified Free Options Available

TUBES AND BOTTLES

Nominal Filling Capacity (mL)	Nominal Size (mm)	Part No.	Rotors See specific rotor pages for required spacers/adapters/accessories
Quick-Seal Ultra-Clear Tubes (cont'd)			
15.0	25 x 38	344324	Types 70 Ti, 60 Ti, 55.2 Ti, 50.2 Ti, VTi 50, MLA-50
27.0	25 x 64	344323	Types 70 Ti, 60 Ti, 55.2 Ti, 50.2 Ti, VTi 50, MLA-50
39.0	25 x 89	344326*	Types 70 Ti, 60 Ti, 55.2 Ti, 50.2 Ti, VTi 50
100.0	38 x 102	345778	Type 45 Ti
Ultra-Clear Tubes			
175 µL	5 x 20	344718	A-110, A-100/30, A-100/18
450 µL	8 x 20	345843	A-95
0.8	5 x 41	344090	SW 55 Ti, SW 50.1, MLS-50
2.0	8 x 49	344091	Types 90 Ti, 80 Ti, 70.1 Ti, 65, 50 Ti, 50.4 Ti, 50.3 Ti, 50, 40, MLA-55
2.2	11 x 34	347356	TLS-55
3.0	13 x 32	344092	Types 90 Ti, 80 Ti, 70.1 Ti, 65, 50 Ti, 50, 40, MLA-55
4.0	11 x 60	344062*	SW 60 Ti
4.0	13 x 41	344093	Types 90 Ti, 80 Ti, 70.1 Ti, 65, 50 Ti, 50, 40, MLA-55
5.0	13 x 51	344057*	SW 55 Ti, SW 50.1, MLS-50
6.5	13 x 64	344088*	Types 90 Ti, 80 Ti, 70.1 Ti, 70 Ti, 65, 60 Ti, 55.2 Ti, 50.4 Ti, 50.3 Ti, 50.2 Ti, 50 Ti, 45 Ti, 40.3, 40.2, 40, 21, MLA-55
10.0	16 x 64	344089	Type 50
10.5	13 x 89	344087	Types 45 Ti, 21
13.2	14 x 89	344059*	SW 41 Ti
13.5	16 x 76	344085	Types 90 Ti, 80 Ti, 70.1 Ti, 70 Ti, 65, 60 Ti, 55.2 Ti, 50.2 Ti, 50 Ti, 45 Ti, 40, 21, MLA-55
14.0	14 x 95	344060*	SW 40 Ti
17.0	16 x 102	344061*	SW 32.1 Ti, SW 28.1
38.5	25 x 89	344058*	Types 70 Ti, 60 Ti, 55.2 Ti, 50.2 Ti, SW 32 Ti, SW 28
94.0	38 x 102	345777	Types 45 Ti, 21
Thinwall Polypropylene Tubes			
175 µL	5 x 20	342630	TLS-55, A-110, A-100/30, A-100/18
2.2	11 x 34	347357	TLS-55
4.0	11 x 60	328874*	SW 60 Ti
5.0	13 x 51	326819	SW 55 Ti, SW 50.1, MLS-50
6.5	13 x 64	326820	Types 90 Ti, 80 Ti, 70.1 Ti, 70 Ti, 65, 60 Ti, 55.2 Ti, 50.4 Ti, 50.3 Ti, 50.2 Ti, 50 Ti, 45 Ti, 40, 40.3, 40.2, 21, MLA-55, MLA-50
10.5	13 x 89	326822	Types 45 Ti, 21
13.2	14 x 89	331372*	SW 41 Ti
13.5	16 x 76	326814	Types 90 Ti, 80 Ti, 70.1 Ti, 70 Ti, 65, 60 Ti, 55.2 Ti, 50.2 Ti, 50 Ti, 45 Ti, 40, 30, 21, MLA-55, MLA-50
14.0	14 x 95	331374*	SW 40 Ti
17.0	16 x 102	337986	SW 32.1 Ti, SW 28.1
35.5	25 x 83	344367	Type 70 Ti
38.5	25 x 89	326823*	Types 70 Ti, 60 Ti, 55.2 Ti, 50.2 Ti, SW 32 Ti, SW 28
94.0	38 x 102	345775	Types 45 Ti, 21
Thinwall Polypropylene, konical Tubes			
1.5	11 x 35	358117	SW 60 Ti
3.0	11 x 60	358118	SW 60 Ti
3.0	13 x 51	358119	SW 55 Ti, SW 50.1 Ti, MLS-50
10.0	14 x 89	358120	SW 41 Ti, SW 40 Ti
11.0	14 x 95	358121	SW 40 Ti
14.5	16 x 102	358123	SW 32.1 Ti, SW 28.1
25.0	25 x 76	358125	SW 32 Ti, SW 28
30.0	25 x 89	358126*	SW 32 Ti, SW 28

* Sterile and Certified Free Options Available

1. Analytical UC
2. Floor Prep UC
3. Tabletop UC
4. Micro-UC
5. Tubes
6. Accessories
7. Reference
8. Support

TUBES AND BOTTLES

Nominal Filling Capacity (mL)	Nominal Size (mm)	Part No.	Rotors See specific rotor pages for required spacers/adapters/accessories
Thickwall Polypropylene Tubes			
230 µL	7 x 20	343621	Type 42.2 Ti, TLA-100
0.5	8 x 34	343777	TLA-120.1, TLA-100.1
1.0	11 x 34	347287	TLA-120.2, TLA-100.2, MLA-130, MLA-150, TLS-55
3.0	11 x 60	355636	SW 60 Ti
3.2	13 x 56	362333	TLA-110, TLA-100.4
3.5	13 x 51	349623	SW 55 Ti, SW 50.1, TLA-100.3, MLS-50
4.0	13 x 64	355644	"Types 90 Ti, 80 Ti, 70.1 Ti, 70 Ti, 65, 60 Ti, 55.2 Ti, 50.4 Ti, 50.3 Ti, 50.2 Ti, 50 Ti, 45 Ti, 40, 21, MLA-55, MLA-50
6.5	16 x 64	355646	Type 50, MLA-80
10.0	16 x 76	355640	"Types 90 Ti, 80 Ti, 75 Ti, 70.1 Ti, 70 Ti, 65, 60 Ti, 55.2 Ti, 50.2 Ti, 50 Ti, 45 Ti, 42.1, 40, 35, 30, 21, SW 25.1, MLA-55, MLA-50
10.5	13 x 89	355639	Types 45 Ti, 21
32.0	25 x 89	355642	Types 70 Ti, 60 Ti, 55.2 Ti, 50.2 Ti, SW 32 Ti, SW 28
94.0	38 x 102	355643	Types 45 Ti, 21
Thickwall Polycarbonate Tubes			
230 µL	7 x 20	343775	Type 42.2 Ti, TLA-100, TLS-55
0.5	8 x 34	343776	TLA-120.1, TLA-100.1
1.0	8 x 51	355657	Types 50.4 Ti, 25
1.0	11 x 34	343778	TLA-120.2, TLA-100.2, MLA-130, MLA-150, TLS-55
3.0	11 x 60	355635	SW 60 Ti
3.2	13 x 56	362305	TLA-110, TLA-100.4
3.5	13 x 51	349622	SW 55 Ti, SW 50.1, TLA-100.3, MLS-50
4.0	13 x 64	355645	"Types 90 Ti, 80 Ti, 70.1 Ti, 70 Ti, 65, 60 Ti, 55.2 Ti, 50.4 Ti, 50.3 Ti, 50.2 Ti, 50 Ti, 45 Ti, 40, 21, MLA-55, MLA-50
6.5	16 x 64	355647	Type 50, MLA-80
10.0	16 x 76	355630	"Types 90 Ti, 80 Ti, 75 Ti, 70.1 Ti, 70 Ti, 65, 60 Ti, 55.2 Ti, 50.2 Ti, 50 Ti, 45 Ti, 40, 21, MLA-55, MLA-50
10.5	13 x 89	355629	Types 45 Ti, 21
32.0	25 x 89	355631	Types 70 Ti, 60 Ti, 55.2 Ti, 50.2 Ti, SW 32 Ti, SW 28
94.0	38 x 102	355628	Types 45 Ti, 21
Cellulose Propionate Tubes			
230 µL	7 x 20	342303	Type 42.2 Ti
Stainless Steel Tubes			
38.5	25 x 89	301112	Types 70 Ti, 60 Ti, 55.2 Ti, 50.2 Ti, 42.1,
94.0	38 x 102	303380	Types 45 Ti, 21
Polyethylene Tubes			
175 µL	5 x 20	343622	TLS-55, A-110, A-100/30, A-100/18
Polypropylene Tubes with Snap-on Caps			
1.5	11 x 40	357448 (Natural)	TLA-110, TLA-100.4, TLA-100.3, TLA-55, TLA-45

BOTTLE ASSEMBLIES WITH THREE-PIECE CAPS







Nominal Filling Capacity (mL)	Nominal Size (mm)	Bottle & Cap Assembly	Bottle Only	Cap Assembly	Cap Only	Plug Only	O-ring Only	Rotors
Bottle and Cap Assembly								
PC — 8.5	16 x 64	355615	355656	355604	335257	335256	870409	Type 50
PC — 10.4	16 x 76	355603	355651	355604	335257	335256	870409	Types 90 Ti, 80 Ti, 75 Ti, 70.1 Ti, 65, 50 Ti, 40, MLA-55
PC — 26.3	25 x 89	355616 ¹	355654	355617	335259	335258	870385	Type 30
PC — 26.3	25 x 89	355618 ¹	355654	355619	338824	335258	870385	Types 70 Ti, 60 Ti, 55.2 Ti, 50.2 Ti, 42.1"
PC — 70.0	38 x 102	355620 ²	355655	355621	334547	334545	870384	Types 35, 21
PC — 70.0	38 x 102	355622 ²	355655	355623	339165	334545	870384	Type 45 Ti
PA — 250.0	60 x 120	334205	355627	362247	362246	332836	812715	Type 19
PP — 250.0	62 x 122	356011	358326	358977	357490	N/A	927860	Type 16
PC — 250.0	62 x 122	356013	358275	358977	357490	N/A	927860	Type 16

Note: Regarding packaging, bottle and cap assemblies are packaged in units of 6, with the following exceptions: Bottle and Cap assembly 334205 is packaged as one; Bottles 355656 and 355651 are packaged in units of 25; Cap assembly 334543 is packaged as one. Caps, Plugs, and O-rings are packaged separately.

- The only difference between these two assemblies is the cap which is Noryl in the 355616 assembly and aluminum in the 355618 assembly. The Noryl cap can be used in the Type 30 Rotor.
- The only difference between these two assemblies is the cap which is Noryl in the 355620 assembly and aluminum in the 355622 assembly. The Noryl cap can be used in the Type 35 and 21 Rotors; the aluminum cap is required for the higher speed forces of the Type 45 Ti.

TUBES AND BOTTLES

Tube Cap Assemblies and Parts

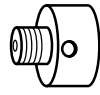
Cap Material	Tube Cap	Hex Nut	Crown	Set Screw	Insert	O-ring or Gasket	Stem
							
5/16 in. (8mm)							
Al	303624	303379	303809	-	-	303730	303377
Al	303658	303379	303810	-	-	303730	303377
1/2 in. (13 mm)							
Al	303113	301870	307004	-	-	344672	307005
Al	346256	301870	307004	803543	302312	344672	346246
Al/SS	305022	301870	307004			344672	302331
5/8 in. (16 mm)							
Al	303319	301870	307006	338864	302312	301869	302266
Al	330860	301870	330774	803543	302312	858046	330788
Al	338907	301870	338911	338864	302312	878572	338910
Ti	341968	335320	335319	338864	302312	858046	341969
1 in. (25 mm)							
Al	302359	301870	302169	338864	302312	301473	302168
Al	302133	301870	302169	338864	302312	301473	302138
Al	331151	330791	331153*	338864	302312	334280	331152
Al/Ti	337927	330791	338863*	338864	302312	-	338865
Al	338901	330791	338912*	338864	302312	878188	338908
Al	338906	330791	338915*	338864	302312	878188	338908
1 1/2 in. (38 mm)							
Al	326891	301870	326890	808482	302312	346242	326889
Al	326905	301870	326890	338864	302312	801761	326899
Al	330901	330791	330793*	338864	302312	346242	330900
Al	338903	330791	338914*	338864	302312	341767	338909
Al	338905	330791	338913*	338864	302312	341767	338909

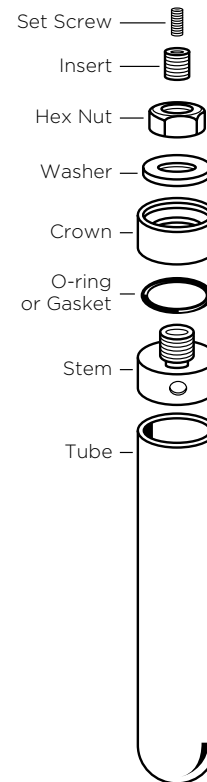

* Also order 330899 Washer.

ACCESSORIES

Sample preparation and recovery are important steps in the centrifugation process. To help in these often time-consuming steps, Beckman Coulter provides a number of tools and accessories for use in preparing your samples for centrifugation as well as for recovering the particles of interest when your separation is complete.

Everything you need can be conveniently ordered from the following listings.

TOOLS AND SUPPLIES

Required Tools

If you're running capped tubes in the following rotors: Types 90 Ti, 75 Ti, 70.1 Ti, 70 Ti, 60 Ti, 55.2 Ti, 50.2 Ti, 50 Ti, 45 Ti, 42.1, 35, or MLA-55, you'll need the following tools. Tools also needed for Types 30 and 21 rotors if capped thickwall tubes are used.

331202	Tool Kit	305075	Cap Vise
--------	----------	--------	----------

If you're running 337927 caps in the Type 70 Ti rotor, you'll need:

338841	Tool Kit	305075	Cap Vise
--------	----------	--------	----------

If you're running Quick-Seal tubes, you'll need:

358312	Tube Topper Kit, 60 Hz (U.S./Canada/Japan)
358313	Tube Topper Kit, 50 Hz (for Europe)
358314	Tube Topper Kit, 50 Hz (for Great Britain)
358315	Tube Topper Kit, 50 Hz (for Australia)

Note: For further information, refer to the specific technical bulletin from the Technical Publications Department.

Tools for Fixed-Angle Rotors (see also Tools for Quick-Seal Tubes)

301875	Removal Tool, for capped tubes
--------	--------------------------------

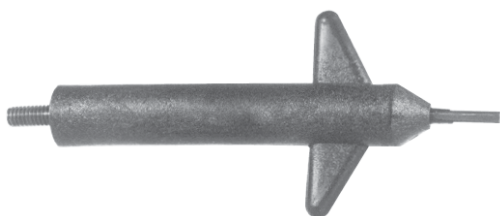

841884	Hex Driver, for 5/16 -in. (8 mm) hex nuts
--------	---

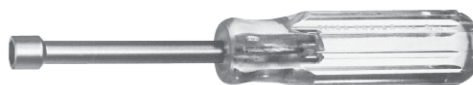

302460	Nylon Insert Tool, for cap stem filling hole
--------	--



858122	Socket Adapter, for 858123 Socket below
--------	---



305075	Tube-Cap Vise
--------	---------------

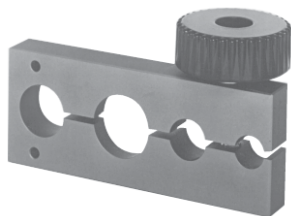

858123	Socket, for tightening red, blue, and black aluminum caps, 3/4-in. (19 mm) hex nut
--------	--

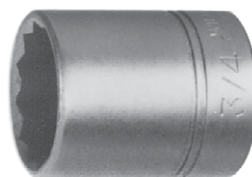

841883	Hex Driver, for 7/16-in. (11 mm) hex nuts
--------	---

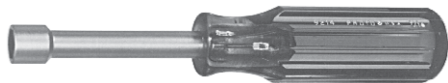



870432	Socket, for tightening titanium caps (cap 341968), 7/16-in. (11 mm) hex nut
--------	---

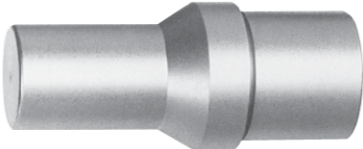

TOOLS AND SUPPLIES

Tools for Fixed-Angle Rotors (cont.)

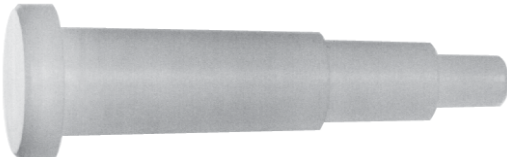
878133	Removal Tool, for polycarbonate bottles with aluminum caps	331325	Centering Tool, for replacing overspeed disk
			
338841	<p>Tool Kit, for Type 70 Ti Rotor when 344367 Tubes and 337927 Caps are used. Includes the following:</p> <ul style="list-style-type: none"> 301875 Removal Tool, for capped tubes 338835 Tube Cap Vise 338840 Tube Cap Assembler 858121 Torque Wrench 858122 Socket Adapter 858123 Socket, for 3/4 -in. (19 mm) hex nut 870432 Socket, for 7/16 -in. (11 mm) hex nut 	335381	Removal Tool, for polycarbonate bottles with Noryl caps
			
331202	<p>Tool Kit for capped thin-wall and thick-wall tubes when used in Types 90 Ti, 75 Ti, 70.1 Ti, 60 Ti, 55.2 Ti, 50.2 Ti, 50 Ti, 45 Ti, 42.1, 35, and MLA-55 Rotors. Also needed for Types 30 and 21 Rotors if capped thickwall tubes are used. Includes the following:</p> <ul style="list-style-type: none"> 301875 Removal Tool, for capped tubes 858121 Torque Wrench 858122 Socket Adapter 858123 Socket, for 3/4 -in. (19 mm) hex nut 870432 Socket, for 7/16 -in. (11 mm) hex nut 	303419	Removal Tool, for Delrin tube adapters (not for use with adapters for konical Tubes)
			

TOOLS AND SUPPLIES

Tools for Vertical-Tube and NVT Rotors (See also Tools for Quick-Seal Tubes)

Note: VTi 65, VTi 65.1 and VTi 50 rotors manufactured prior to 8/87 were equipped with pin-style and square-style plugs, and require specific tools mentioned in the bottom of this section. To update these rotors, purchase a full set of the new hex-style plugs and the appropriate tools.

332688	Rotor Vise, for VTi 65 and VTi 50 rotors
--------	--



342705	Rotor Vise, for VTi 90, NVT 100*, NVT 90, NVT-65, VTi 65.1, VTi 65.2, and VAC 50 rotors
--------	---

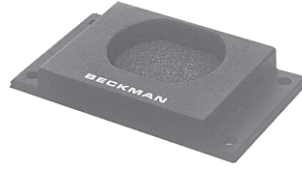

*Requires adapter 367084.

355588	Hex Plug-wrench Adapter for VTi 50, VC 53, VAC 50 Rotors	
356306		Hex Plug-wrench Adapter for VTi 90, VTi 65, VTi 65.1, VTi 65.2, and MLN-80 Rotors
889096	Torque Wrench, 600 in.-lb., for VTi 50, VC 53, VAC 50 Rotors	
858121		Torque Wrench, 200 in.-lb. for VTi 90, VTi 65, VTi 65.1, VTi 65.2, NVT 100, NVT 90, NVT 65.2, VTi 80, TLN-120, TLN-100, and TLN-80 Rotors



Tools for VTi 65, VTi 65.1 and VTi 50 Manufactured before 8/87

340632	Four-hole Plug-wrench Adapter for VTi 50 Rotors
345795	Two-hole Plug-wrench Adapter for VTi 65 Rotors
347372	Hex Plug Adapter for TLN-120, TLN-100, TLV-100
347373	Rotor Vise for TLN-120, TLN-100, TLV-100, TLN-80, MLA-55
889096	Torque Wrench for VTi 50, VC 50, VAC 50
976959	Torx Wrench Adapter for NVT 100, NVT 90, NVT 65.2, VTi 90, VTi 65.2, TLV-100, TLN-120

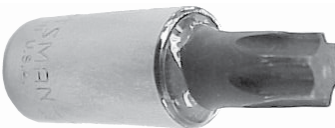

Reminder: These items are supplied with the Rotor Package; order only as replacements

Tools for Swinging-Bucket Rotors

001878	Bucket Cap Tool, for SW 60 Ti Rotor
--------	-------------------------------------



354468	Removal Tool, for konical Tube Adapters	
C46871		Rotor Stand
927208		Hemostat (6-in., curved)
330070		Hinge Pin Tool, for SW 65 Ti, SW 41 Ti and SW 40 Ti Rotors

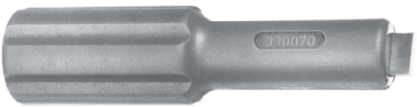

Reminder: These items are supplied with the Rotor Package; order only as replacements

Tools for Swinging-Bucket Rotors

001884	Hex Wrench, 5/64-in. (1.9 mm), for Support Band
332618	
332848	Locating Spacer, for Ti-15, A1-15, Ti-14 Rotors
819247	

328917	Tool Kit, for Zonal Rotors. Includes the following: 332688 Rotor Vise 332690 Spanner Wrench 333763 Tubing Removal Tool 858532 Pliers
--------	--

TOOLS AND SUPPLIES

Supplies

306812	Spinkote Lubricant, 2-oz. tube
335148	Vacuum Grease, 1-oz. jar
339379	Brush, for cleaning rotor cavities, 7/16 in. to 1 in. (11 to 25 mm) in diameter; minimum order of three.
339380	Brush, for cleaning rotor cavities, 1 in. to 1 1/2 in. (25 to 38 mm) in diameter; minimum order of three.
339555	Rotor Cleaning Concentrate, Solution 555, 946-mL bottle; minimum order of two
339558	Rotor Cleaning Kit (see description on page 2-18) includes: one 339379 Brush, one 339380 Brush and two bottles of 339555 Rotor Cleaning Concentrate
347404	Brush, for cleaning rotor cavities, 1/4 in. to 1/2 in. (6 to 13 mm) in diameter; minimum order of three.

330049	Logbook, for Preparative Ultracentrifuge Instruments
--------	--



Tools for Quick-Seal Tubes

338765	Removal Tool, for Floating Spacers (except when used in Swinging Bucket Rotors)
--------	---



354468	Removal Tool, for konical Tube Adapters used in Swinging Bucket Rotors
--------	--



342415	Funnel
--------	--------



339587	Master Rotor Logbook
--------	----------------------

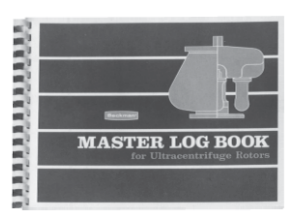

339648	Rotor Record Cards, package of five pads
--------	--



348120	Seal Formers (round-topped) for use with Tube Topper
345395	Ultra-Clear Tube Sealing Oil, 7.5 mL bottle
361668	Removal Tool for Tubes and Spacers (and Floating Spacers in Swinging Bucket Rotors)

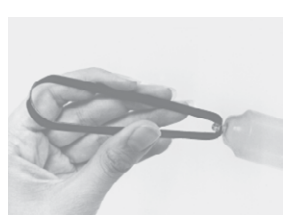

TOOLS AND SUPPLIES

Quick-Seal Tube Racks

For Cordless Tube Topper

These autoclavable racks accommodate Quick-Seal Tubes for use with the Cordless Tube Topper.

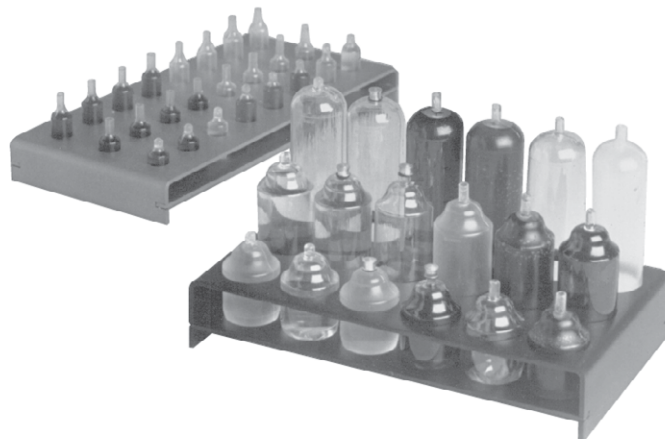

348122	Tube Rack (Red), for 1/2 in. (13 mm) diameter Tubes
348123	Tube Rack (Green), for 5/8 in. (16 mm) diameter Tubes
348124	Tube Rack (Blue), for 1 in. (25 mm) diameter Tubes
348125	Tube Rack (Black), for 1 1/2 in. (38 mm) diameter Tubes
349387	Tube Rack (Gold), for 7/16 in. (11 mm) diameter Tubes
349661	Tube Rack (Orange), for 5/16 in. (8 mm) diameter Tubes
356568	Tube Rack (Violet), for 9/16 in. (14 mm) diameter Tubes

Tools for OptiSeal Tubes

For easy handling of OptiSeal Tubes, specially designed Tube Racks and Removal Tools are available.



338765	Removal Tool, for 5/8-in Floating Spacer (362202)
360538	OptiSeal Tube Rack, for 5/8 x 23/4 in. (16 x 70 mm) Tubes
360542	OptiSeal Tube Rack, for 1 x 31/2 in. (25 x 89 mm) Tubes
361638	OptiSeal Tube Rack, for 1/2 x 17/8 in. (13 x 48 mm) Tubes
361642	OptiSeal Tube Rack, for 5/8 x 23/8 in. (16 x 60 mm) Bell top Tubes
361646	OptiSeal Tube Rack, for 1 x 31/4 in. (25 x 77 mm) Bell top Tubes
361650	OptiSeal Tube Rack, for 1/2 x 115/16 in. (13 x 33 mm) Tubes
361668	OptiSeal Tube Extraction Tool

Cordless Tube Topper

358312	Tube Topper Kit, 60 Hz
358313	Tube Topper Kit, 50 Hz (for Europe)
358314	Tube Topper Kit, 50 Hz (for Great Britain)
358315	Tube Topper Kit, 50 Hz (for Australia)
367803	Tube Topper Kit, 60 Hz (for Canada)

Each Kit Contains:

1 each 348117 Heatsink, 2 each 348643 Seal Guide, 8 each 348120 Seal Former (domed top), 1 each Tube Topper and Charging Unit, 1 each 361668 Tube Extractor.

Replacement Parts

338765	Removal Tool for Plastic Spacers and Floating Spacers
342415	Funnels (two)
348117	Heat Sink
348120	Seal Former (domed top) for Tube Topper
348643	Seal Guide
357442	Flat-top Seal Former for Tube Sealer
358317	Tip
889676	Plastic Box for holding Accessories
927937	Battery
961601	Lamp (screw-type socket)
974874	Lamp (bayonet-type socket)



Tube Slicer — for Preparative Ultracentrifuge Tubes

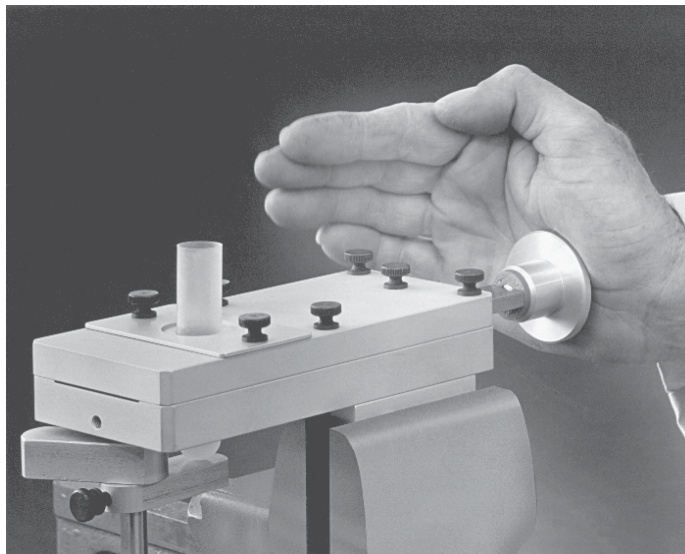

303811 Tube Slicer Kit, contains parts listed below.
(Note: Vise not included.)

Replacement Parts

303830	Blade Assembly
303838	Blade
303917	Rubber Ring, 1-in. (25 mm), two required
303918	Rubber Ring, 5/8 -in. (16 mm), two required
303919	Rubber Ring, 1/2 -in. (13 mm), two required
303920	Rubber Ring, 5/16 -in. (8 mm), two required
303921	Metal Shim Ring, 1-in. (25 mm), two required
303922	Metal Shim Ring, 5/8 -in. (16 mm), two required
303923	Metal Shim Ring, 7/16 -in. (13 mm), two required
303924	Metal Shim Ring, 5/16 -in. (8 mm), two required
332692	Metal Shim Ring, 9/16 -in. (14 mm), two required
332693	Rubber Ring, 9/16 -in. (14 mm), two required
338516	Rubber Ring, 7/16 -in. (11 mm), two required
338517	Metal Shim Ring, 7/16 -in. (11 mm), two required
829623	Thumbscrew

CentriTube Slicer — for Micro Ultracentrifuge Tubes



347960 CentriTube Slicer Kit. Includes Adapter Plates, Blades, Storage Box, Hardware Kit, Spinkote Lubricant, and Instruction Manual.

Replacement Parts

306812	Spinkote Lubricant
348299	Blades, coated package of 10
348307	Replacement Hardware Kit (3 thumbscrews, 1 set of blade clips)
354443	Adapter Plate, 13 mm diameter
354444	Adapter Plate, 11 mm diameter
354445	Adapter Plate, 8 mm diameter
354446	Adapter Plate, 7 mm diameter
354471	Blades, uncoated, package of 10
889676	Plastic Storage Box

Rotor Cleaning Kit



339558	Rotor Cleaning Kit. Contains two 946-mL bottles of Solution 555 Rotor Cleaning Concentrate, 339379 Rotor Cleaning Brush, and 339380 Rotor Cleaning Brush
--------	--

Replacement Parts/Supplies

339379	Rotor Cleaning Brush, 5/8-in. (16 mm) and 1-in. (25.4 mm), for Rotor Cavity diameters from 7/16-in. (11 mm) to 1-in. (25.4 mm) (min. order three Brushes)
339380	Rotor Cleaning Brush, 1/4-in. (32 mm) and 1/2-in. (38 mm), for Rotor Cavity diameters from 1-in. (25.4 mm) to 1/2-in. (38 mm) (min. order three Brushes)
339555	Solution 555 Rotor Cleaning Concentrate (min. order two Bottles)

Fraction Recovery System

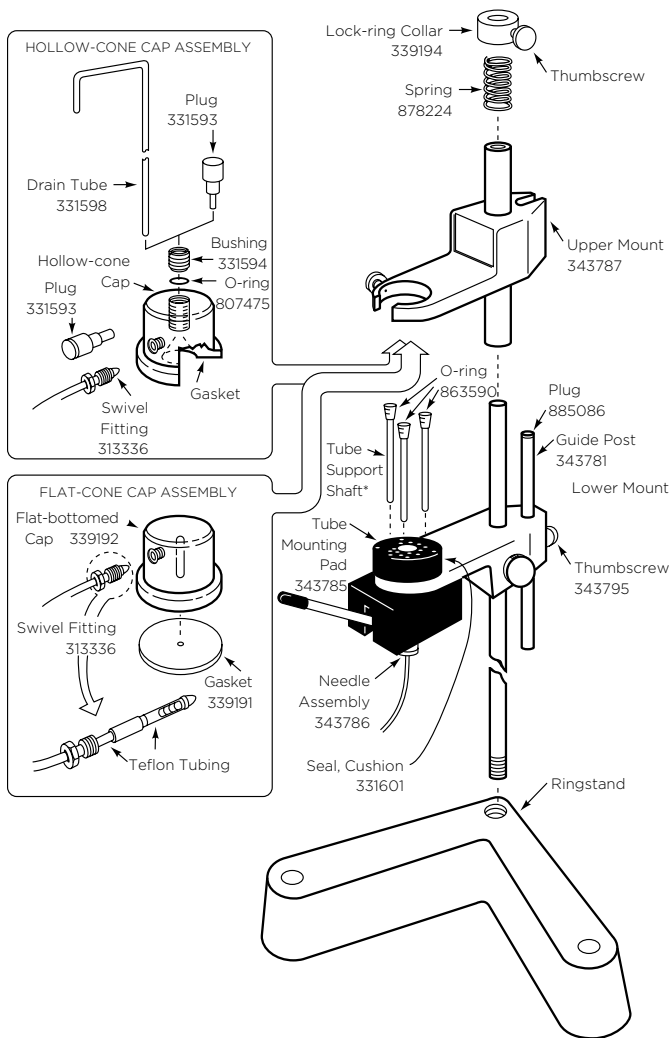

Two types of systems are available: one with a flatbottomed cap, and those with hollow-cone caps. Using the flat-bottomed cap, sample is removed through a puncture hole in the bottom of the tube. This cap fits any tube diameter and must be used to fractionate Quick-Seal tubes. The four hollow-cone cap systems are used for sample recovery from tubes that cannot be punctured or for recovery from the tops or bottoms of puncturable tubes. Each hollow-cone system is for a single tube diameter.

System Part Numbers

342023	Fraction Recovery System with Hollow-cone Cap for 1/2 -in. Tubes.
342024	Fraction Recovery System with Hollow-cone Cap for 5/8 -in. Tubes.
342025	Fraction Recovery System with Hollow-cone Cap for 7/16 -in. Tubes.
342026	Fraction Recovery System with Hollow-cone Cap for 1-in. Tubes.
343890	Fraction Recovery System with flat-bottomed Cap for puncturing all Tubes, including Quick-Seal Tubes*.

Hollow-Cone Caps

331562	Hollow-cone Cap for 1-in. diameter Tubes
331563	Hollow-cone Cap for 1 1/4 -in. diameter Tubes
331564	Hollow-cone Cap for 5/8 -in. diameter Tubes
331565	Hollow-cone Cap for 1/2 -in. diameter Tubes
331566	Hollow-cone Cap for 9/16 -in. diameter Tubes
331586	Gasket for 331566 Cap
331587	Gasket for 331565 Cap
331588	Gasket for 331564 Cap
331589	Gasket for 331563 Cap
331591	Gasket for 331562 Cap
334310	Hollow-cone Cap for 7/16 -in. diameter Tubes
334312	Gasket for 334310 Cap

Replacement Parts for Discontinued 339187 Universal Fraction Recovery System

331584	Piercing Screw
343786	Needle Assembly
343804	Retrofit Kit, includes lower mount (shown left) for lever puncturing to 343890
819838	Setscrew with plastic tip

* 346105 Tube Support Shaft, 2-in., 346106 Tube Support Shaft, 3-in., both included in 343890

Ultracentrifuge Reference Information

Instrument Classification

Each Beckman Coulter preparative ultracentrifuge carries a safety classification that defines which Beckman Coulter rotors may be safely operated in that centrifuge. The letter classifications (from A to T) take into account rotor energies, size of the rotor chamber, and instrument updates. The classification is indicated on a decal near the rotor chamber or in the About section of the instrument software (depending on the model). If you are unsure of your ultracentrifuge's correct classification, please call your local Beckman Coulter Service Engineer for assistance. Instruments currently being manufactured are classified as S.

Before ordering a rotor, check your instrument's classification to make certain it will accommodate the rotor selected. Each rotor listing on the following pages indicates the instrument classifications in which they can be used.

Beckman Coulter rotors and ultracentrifuges are designed and tested as complete systems, and engineered for safe, reliable operation. We do not test Beckman Coulter rotors in non-Beckman Coulter ultracentrifuges, nor non-Beckman Coulter rotors in Beckman Coulter ultracentrifuges. It is not recommended that Beckman Coulter rotors be used in other instruments or that rotors made by other manufacturers be used in Beckman Coulter ultracentrifuges.

Speed Reductions

When using any rotor, be sure to observe the instructions given in the appropriate Rotor Manual. Speed limitations lower than those given in this Product Selection Guide may be required because of weight considerations—the weight of a tube, a cap, or the density of the solution being centrifuged. Other considerations, such as the precipitation of cesium salt, require deration of the rotor as well. Use the equations of the CsCl deration curves given in the Rotor Manual to determine the correct rotor speed. If a Rotor Manual has been lost, contact your local Beckman Coulter office to request a replacement.

Preparative Floor Model Rotor Designations

All fixed-angle preparative floor model ultracentrifuge rotors are designated by the word Type, vertical-tube rotors by the symbol VT, near-vertical by the symbol NVT, and swinging bucket rotors by the symbol SW. The symbol Ti means the rotor is made of titanium. All other rotors are made of aluminum.

k Factors

The *k* Factors shown in the rotor charts can be used to compare the efficiency of various rotors for the material that will be centrifuged. They are a guide to the time, *t* (in hours), required to pellet a particle of known sedimentation coefficient, *s* (in Svedberg units): $t = k/s$.

Centrifugal Forces

The centrifugal forces given for rotors in these publications have been rounded to three significant figures using the formula where *r* is the radius in millimeters.

$$g = 1.118r \left(\frac{\text{rpm}}{1000} \right)^2, \text{ RPM} = \sqrt{\frac{\text{RCF}}{1.12r}}$$

Tube Kits

For your ordering convenience, most Beckman Coulter Fixed-Angle Rotors are sold as Rotor Assemblies with a choice of Tube Kits. For rotors that accommodate OptiSeal and Quick-Seal tubes, you can order kits with these tubes instead of a Rotor Package with capped tubes only. Each kit comes complete with up to 200 tubes, the appropriate number of cap assemblies or spacers, Vacuum Grease, and, in the case of the OptiSeal and Quick-Seal Kits, a Tube Rack. For complete ordering information, see the individual rotor listings that follow.

Use of Small Tubes

With the use of appropriate spacers and/or adapters, many rotors can accommodate tubes smaller than the tube cavities. When centrifuging small samples, use of these smaller tubes increases the efficiency and speeds the process. A chart of compatible tubes is provided with each rotor listing.

Innovative g-Max System

The *g*-Max system adds valuable capabilities to your Beckman Coulter ultracentrifuge rotors. Based on a unique approach to tube support within the rotor cavities, the system lets you run smaller volumes in Fixed-Angle, Vertical-Tube and Swinging Bucket Rotors with no reduction in *g*-force and at lower *k* Factors to achieve separations in much shorter run times.

This system uses patented Beckman Coulter Quick-Seal bell-top tubes and floating spacers. Unlike conventional sleeve-type adapters, the *g*-Max spacers “float” on top of the tube which keeps the sample at the maximum radius of the tube cavity.

Note: To help you locate *g*-Max tubes in the rotor listings, these tubes are highlighted with bold, italic type. To make it easy to order these tubes the first time, *g*-Max kits are available which include enough spacers to completely fill the rotor, as well as 50 Quick-Seal polypropylene tubes and two tools (one for spacer removal and one for tube removal). These kits are also listed.

Rotor Calculator

Moving a centrifugation protocol to a new setup can be challenging to calculate by hand. Beckman Coulter offers a tool to save you time and simplify protocol transfer. Go here to check out the rotor calculator tool: beckman.com/centrifuges/rotors/calculator.

How to Choose a Rotor

When choosing a rotor, there are several factors to consider: your sample volume and number of individual samples; the number of components in each sample; the level of purity your research requires; and how quickly you wish to achieve the separation.

The Importance of *k* Factor

Obviously, separation is affected by maximum speed and maximum radius which together determine maximum *g*-force. However, particle pathlength also affects separation time. A simple measure of overall rotor efficiency which incorporates both *g*-force and particle pathlength is the *k* Factor. Generally speaking, the lower the *k* Factor, the shorter the run time. This makes the *k* Factor one of the most important considerations when selecting a rotor. The chart on 4-5 compares *k* Factors among the four basic rotor types. (Refer to page 4-12 for useful formulas relating to *k* Factors.)

Rotor Material

Beckman Coulter ultracentrifuge rotors are made of either aluminum, or titanium.

- Aluminum rotors are relatively light and easy to handle, but less durable and slightly more susceptible to corrosion than titanium rotors. Beckman Coulter still offers some aluminum rotors for customers who own older ultracentrifuges, the primary instruments for which these rotors were originally designed.
- Titanium rotors are generally stronger and more resistant to corrosion, making them the logical choice for rapid separation at high speeds or when corrosive chemicals will be used.

Swinging-Bucket (SW) Rotors

Generally used when maximum resolution of sample zones is needed, as in rate zonal studies. Because tubes are held in a horizontal position while spinning, the pathlength is the full length of the tube, which results in longer run times than with other rotor types. These long run times are offset by excellent resolution of sample bands in rate zonal separations. Swinging-Bucket Rotors are also the best choice when a compact pellet is needed, as when pelleting RNA through a cesium chloride cushion.

Fixed-Angle (FA) Rotors

These rotors provide faster run times than SW rotors at the expense of some resolution in rate zonal studies. They are most useful for pelleting and for isopycnic banding of DNA, where a shallow density gradient and reorientation combine to increase both the width of sample bands and the distance between them, making band extraction easier.

Vertical-Tube (VT) Rotors

These rotors are often used for isopycnic and rate zonal separations when run-time reduction is important. Since vertical tube rotors hold sample tubes parallel to the axis of rotation, particle pathlengths are limited to the diameter of the tube — a short pathlength that results in fast run times.

Near-Vertical Tube (NVT) Rotors

NVT Near-Vertical Tube Rotors, a patented Beckman Coulter innovation, were designed specifically for density gradient separations. Their narrow angle of less than 10° is calculated using a proprietary algorithm which determines the optimal angle for each rotor, taking into consideration specific tube geometries. These angles result in significantly reduced run times compared with conventional Fixed-Angle Rotors, while positioning pelleted and floated components at the ends of the tubes, away from the bands of interest.

Continuous-Flow/Zonal Rotors

These rotors are capable of processing large sample volumes in their cores. This large-scale processing ability is clearly evident in Continuous-Flow Rotors, which can process a typical 10-liter sample in about four hours, instead of the 12-24 hours required by conventional methods. Zonal Rotors have similar utility in large-scale density gradient separations.

Particle Separation in Swinging-Bucket, Fixed-Angle, Near-Vertical Tube, and Vertical-Tube Rotors

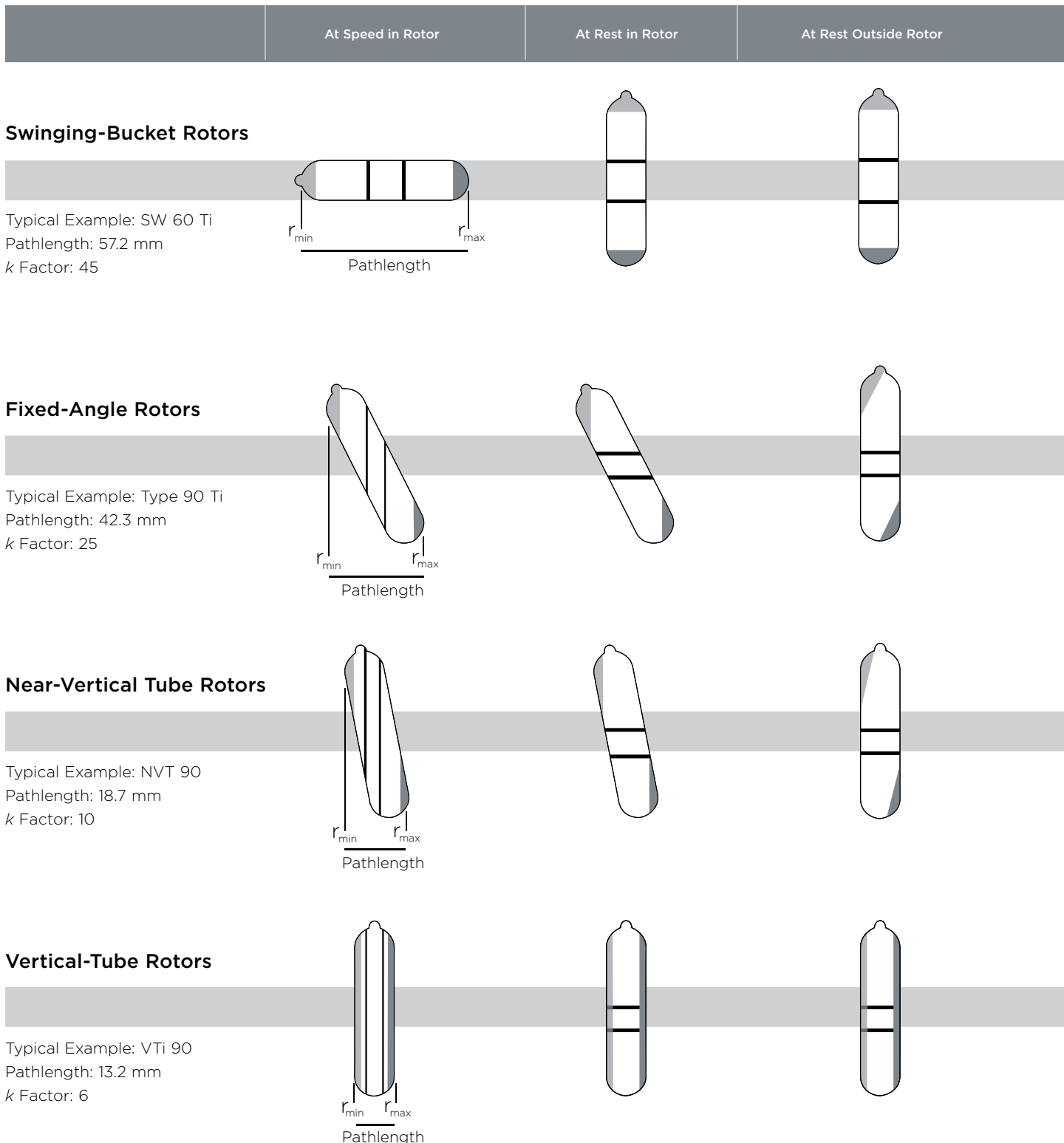

Dark orange represents pelleted material, light orange depicts floating components, and bands are indicated by black lines.

Gradient Materials

There is no ideal all-purpose gradient material. Sucrose is used for most rate separations and cesium chloride is often used for isopycnic separations. The basic requirement is that the gradient permits the desired type of separation. Additional considerations in selecting a gradient material include the following:

- Its density range should be sufficient to permit separation of the particles of interest by the chosen density gradient technique, without overstressing the rotor.
- It should not affect the biological activity of the sample.
- It should be neither hyperosmotic nor hypoosmotic when the sample is composed of sensitive organelles.
- It should not interfere with the assay technique.
- It should be removable from the purified product.
- It should not absorb in the ultraviolet or visible range.
- It should be inexpensive and readily available; more expensive materials should be recoverable for reuse.
- It should be sterilizable.
- It should not be corrosive to the rotor, particularly for zonal or continuous-flow operation.
- It should not be flammable or toxic to the extent that its aerosols could be hazardous.

The following tables are provided as a reference for information on commonly used gradient materials.

Commonly Used Gradient Materials with Their Solvents

Materials	Solvent	Maximum Density at 20°C
Sucrose (66%)	H ₂ O	1.32
Sucrose (65%)	D ₂ O	1.37
Silica sols	H ₂ O	1.30
Diodon	H ₂ O	1.37
Glycerol	H ₂ O	1.26
Cesium chloride	H ₂ O	1.91
	D ₂ O	1.98
Cesium formate	H ₂ O	2.10
Cesium acetate	H ₂ O	2.00
Rubidium chloride	H ₂ O	1.49
Rubidium formate	H ₂ O	1.85
Rubidium bromide	H ₂ O	1.63
Potassium acetate	H ₂ O	1.41
Potassium formate	H ₂ O	1.57
	D ₂ O	1.63
Sodium formate	H ₂ O	1.32
	D ₂ O	1.40
Lithium bromide	H ₂ O	1.83
Lithium chloride	D ₂ O	1.33
Albumin	H ₂ O	1.35
Sorbitol	H ₂ O	1.39
Ficoll	H ₂ O	1.17
Metrizamide	H ₂ O	1.46

REFERENCE

Density, Refractive Index, and Concentration Data - Cesium Chloride at 25°C, Molecular Weight = 168.37

Density (g/cm ³)*	Refractive Index, n_D	% by Weight	mg/ml of Solution**	Molarity	Density (g/cm ³)*	Refractive Index, n_D	% by Weight	mg/ml of Solution**	Molarity
1.0047	1.3333	1	10.0	0.056	1.336	1.3657	34	454.2	2.698
1.0125	1.3340	2	20.2	0.119	1.3496	1.3670	35	472.4	2.806
1.0204	1.3348	3	30.6	0.182	1.363	1.3683	36	490.7	2.914
1.0284	1.3356	4	41.1	0.244	1.377	1.3696	37	509.5	3.026
1.0365	1.3364	5	51.8	0.308	1.391	1.3709	38	528.6	3.140
1.0447	1.3372	6	62.8	0.373	1.406	1.3722	39	548.3	3.257
1.0531	1.3380	7	73.7	0.438	1.4196	1.3735	40	567.8	3.372
1.0615	1.3388	8	84.9	0.504	1.435	1.3750	41	588.4	3.495
1.0700	1.3397	9	96.3	0.572	1.450	1.3764	42	609.0	3.617
1.0788	1.3405	10	107.9	0.641	1.465	1.3778	43	630.0	3.742
1.0877	1.3414	11	119.6	0.710	1.481	1.3792	44	651.6	3.870
1.0967	1.3423	12	131.6	0.782	1.4969	1.3807	45	673.6	4.001
1.1059	1.3432	13	143.8	0.854	1.513	1.3822	46	696.0	4.134
1.1151	1.3441	14	156.1	0.927	1.529	1.3837	47	718.6	4.268
1.1245	1.3450	15	168.7	1.002	1.546	1.3852	48	742.1	4.408
1.1340	1.3459	16	181.4	1.077	1.564	1.3868	49	766.4	4.552
1.1437	1.3468	17	194.4	1.155	1.5825	1.3885	50	791.3	4.700
1.1536	1.3478	18	207.6	1.233	1.601	1.3903	51	816.5	4.849
1.1637	1.3488	19	221.1	1.313	1.619	1.3920	52	841.9	5.000
1.1739	1.3498	20	234.8	1.395	1.638	1.3937	53	868.1	5.156
1.1843	1.3508	21	248.7	1.477	1.658	1.3955	54	895.3	5.317
1.1948	1.3518	22	262.9	1.561	1.6778	1.3973	55	922.8	5.481
1.2055	1.3529	23	277.3	1.647	1.699	1.3992	56	951.4	5.651
1.2164	1.3539	24	291.9	1.734	1.720	1.4012	57	980.4	5.823
1.2275	1.3550	25	306.9	1.823	1.741	1.4032	58	1009.8	5.998
1.2387	1.3561	26	322.1	1.913	1.763	1.4052	59	1040.2	6.178
1.2502	1.3572	27	337.6	2.005	1.7846	1.4072	60	1070.8	6.360
1.2619	1.3584	28	353.3	2.098	1.808	1.4093	61	1102.9	6.550
1.2738	1.3596	29	369.4	2.194	1.831	1.4115	62	1135.8	6.746
1.2858	1.3607	30	385.7	2.291	1.856	1.4137	63	1167.3	6.945
1.298	1.3619	31	402.4	2.390	1.880	1.4160	64	1203.2	7.146
1.311	1.3631	32	419.5	2.492	1.9052	1.4183	65	1238.4	7.355
1.324	1.3644	33	436.9	2.595					

Density data are from International Critical Tables.

* Computed from the relationship $p_{25} = 10.2402 \text{ hD}_{25} - 12.6483$ for densities between 1.00 and 1.38, and $p_{25} = /0.8601 \text{ hD}_{25} - 13.4974$ for densities above 1.37 (Bruner and Vinograd, 1965).

** Divide by 10.0 to obtain % w/v.

Density, Refractive Index, and Concentration Data – Sucrose at 20°C, Molecular Weight = 342.3

Density (g/cm ³) [*]	Refractive Index, n_D	% by Weight	mg/ml of Solution [*]	Molarity
0.9982	1.3330	0		
1.0021	1.3344	1	10.0	0.029
1.0060	1.3359	2	20.1	0.059
1.0099	1.3374	3	30.3	0.089
1.0139	1.3388	4	40.6	0.119
1.0179	1.3403	5	50.9	0.149
1.0219	1.3418	6	61.3	0.179
1.0259	1.3433	7	71.8	0.210
1.0299	1.3448	8	82.4	0.211
1.0340	1.3464	9	93.1	0.272
1.0381	1.3479	10	103.8	0.303
1.0423	1.3494	11	114.7	0.335
1.0465	1.3510	12	125.6	0.367
1.0507	1.3526	13	136.6	0.399
1.0549	1.3541	14	147.7	0.431
1.0592	1.3557	15	158.9	0.464
1.0635	1.3573	16	170.2	0.497
1.0678	1.3590	17	181.5	0.530
1.0721	1.3606	18	193.0	0.564
1.0765	1.3622	19	204.5	0.597
1.0810	1.3639	20	216.2	0.632
1.0854	1.3655	21	227.9	0.666
1.0899	1.3672	22	239.8	0.701
1.0944	1.3689	23	251.7	0.735
1.0990	1.3706	24	263.8	0.771
1.1036	1.3723	25	275.9	0.806
1.1082	1.3740	26	288.1	0.842
1.1128	1.3758	27	300.5	0.878
1.1175	1.3775	28	312.9	0.914
1.1222	1.3793	29	325.4	0.951
1.1270	1.3811	30	338.1	0.988
1.1318	1.3829	31	350.9	1.025
1.1366	1.3847	32	363.7	1.063
1.1415	1.3865	33	376.7	1.100

Density (g/cm ³) [*]	Refractive Index, n_D	% by Weight	mg/ml of Solution [*]	Molarity
1.1463	1.3883	34	389.7	1.138
1.1513	1.3902	35	403.0	1.177
1.1562	1.3920	36	416.2	1.216
1.1612	1.3939	37	429.6	1.255
1.1663	1.3958	38	443.2	1.295
1.1713	1.3978	39	456.8	1.334
1.1764	1.3997	40	470.6	1.375
1.1816	1.4016	41	484.5	1.415
1.1868	1.4036	42	498.5	1.456
1.1920	1.4056	43	512.6	1.498
1.1972	1.4076	44	526.8	1.539
1.2025	1.4096	45	541.1	1.581
1.2079	1.4117	46	555.6	1.623
1.2132	1.4137	47	570.2	1.666
1.2186	1.4158	48	584.9	1.709
1.2241	1.4179	49	599.8	1.752
1.2296	1.4200	50	614.8	1.796
1.2351	1.4221	51	629.9	1.840
1.2406	1.4242	52	645.1	1.885
1.2462	1.4264	53	660.5	1.930
1.2519	1.4285	54	676.0	1.975
1.2575	1.5307	55	691.6	2.020
1.2632	1.4329	56	707.4	2.067
1.2690	1.4351	57	723.3	2.113
1.2748	1.4373	58	739.4	2.160
1.2806	1.4396	59	755.6	2.207
1.2865	1.4418	60	771.9	2.255
1.2924	1.4441	61	788.3	2.303
1.2983	1.4464	62	804.9	2.351
1.3043	1.4486	63	821.7	2.401
1.3103	1.4509	64	838.6	2.450
1.3163	1.4532	65	855.6	2.500
1.3224	1.4558	66	872.8	2.550
1.3286	1.4581	67	890.2	2.864

Density and refractive index data are from the International Critical Tables.

* Divide by 10.0 to obtain % w/v.

REFERENCE

Density Conversion for Cesium and Rubidium Salts at 20°C

Sucrose at 20°C, Molecular Weight = 342.3

% w/w	CsCl	CsBr	CsI	Cs ₂ SO ₄	CsNO ₃	RbCl	RbBr	RbI	Rb ₂ SO ₄	RbNO ₃
1	1.00593	1.00612	1.00608	1.0061	1.00566	1.00561	1.00593	1.00591	1.0066	1.0053
2	1.01374	1.01412	1.01402	1.0144	1.01319	1.01307	1.01372	1.01370	1.0150	1.0125
4	1.02969	1.03048	1.03029	1.0316	1.02859	1.02825	1.02965	1.02963	1.0322	1.0272
6	1.04609	1.04734	1.04707	1.0494	1.04443	1.04379	1.04604	1.04604	1.0499	1.0422
8	1.06297	1.06472	1.06438	1.0676	1.06072	1.05917	1.06291	1.06296	1.0680	1.0575
10	1.08036	1.08265	1.08225	1.0870	1.07745	1.07604	1.08028	1.08041	1.0864	1.0731
12	1.09828	1.10116	1.10071	1.1071	1.09463	1.09281	1.09817	1.09842	1.1052	1.0892
14	1.11676	1.12029	1.11979	1.1275	1.11227	1.11004	1.11661	1.11701	1.1246	1.1057
16	1.13582	1.14007	1.13953	1.1484		1.12775	1.13563	1.13621	1.1446	1.1227
18	1.15549	1.16053	1.15996	1.1696		1.14596	1.15526	1.15605	1.1652	1.1401
20	1.17580	1.18107	1.18112	1.1913		1.16469	1.17554	1.17657	1.1864	1.1580
22	1.19679	1.20362	1.20305	1.2137		1.18396	1.19650	1.19781	1.2083	1.1763
24	1.21849	1.22634	1.22580	1.2375		1.20379	1.21817	1.21980	1.2309	1.1952
26	1.24093	1.24990	1.24942	1.2643		1.22421	1.24059	1.24257	1.2542	1.2146
28	1.26414	1.27435	1.27395			1.24524	1.26380	1.26616	1.2782	1.2346
30	1.28817	1.29973	1.29944			1.26691	1.28784	1.29061	1.3028	1.2552
35	1.35218	1.36764	1.36776			1.32407	1.35191	1.35598	1.3281	1.2764
40	1.42245	1.44275	1.44354			1.38599	1.42233	1.42806		
45	1.49993	1.52626	1.52803			1.45330	1.50010	1.50792		
50	1.58575	1.61970	1.62278			1.52675	1.58639	1.59691		
55	1.68137	1.72492					1.68254	1.69667		
60	1.78859							1.80924		
65	1.90966							1.93722		

Useful Formulas

k Factor

To determine *k* Factor

$$k = \frac{\ln (r_{\max} / r_{\min})}{\omega^2} \times \frac{10^{-13}}{3600} \quad \text{OR} \quad k = \frac{2.53 \times 10^5 \ln (r_{\max} / r_{\min})}{(\text{rpm}/1000)^2}$$

To determine pelleting time (*t*)

$$t = \frac{k}{s} \quad \text{where } s = \text{sedimentation coefficient in Svedbergs}$$

To relate pelleting time between rotors

$$\frac{k_1}{t_1} = \frac{k_2}{t_2}$$

To adjust *k* Factor for runs less than maximum rotor speed

$$k_{\text{adj}} = k \left(\frac{\text{maximum rated speed of rotor}}{\text{actual run speed}} \right)^2$$

To relate relative centrifugal force (RCF) to speed (rpm):

$$\text{RCF}_{\max} = 1.118 r_{\max} \left(\frac{\text{rpm}}{1000} \right)^2 \quad \text{OR} \quad \text{rpm} = 10^3 \sqrt{\frac{\text{RCF}}{1.12 r_{\max}}}$$

To relate the sedimentation coefficient (s) to rotational speed:

$$s = \frac{dr}{dt} \times \frac{1}{\omega^2 r}$$

Svedberg unit (S) equivalent:

$$S = 10^{-13} \text{ seconds}$$

Reduced run speed for dense solutions:

$$\text{reduced run speed} = \text{max rated speed of rotor} \times \sqrt{A/B}$$

where A = max. permissible density of rotor tube contents, and
B = actual density of the tubes to be centrifuged

Field Service Support

Most of us appreciate the need for careful design, handling, and maintenance of certain kinds of laboratory equipment—the optics of a spectrophotometer, for example. It may not be obvious, however, that anything as substantial looking as a centrifuge rotor must be properly maintained during use in order for it to fulfill its life expectancy.

If you consider that, during rotation, an Ultracentrifuge Rotor may experience more than 1,000,000 times the force of gravity, it becomes apparent that seemingly minor flaws will assume much greater significance at these g -forces. In effect, one gram will “weigh” 1,000 kilograms, and a tiny flaw in a critical part may generate stresses greater than the rotor was designed to withstand.

We at Beckman Coulter maintain stringent quality standards and rigorously test every rotor design. Specific instructions for care and maintenance are included in the rotor manual that accompanies each rotor. And our Field Rotor Inspection Program is available at no charge to all users of Beckman Coulter Ultracentrifuges and High-Speed Centrifuges.

Field Rotor Inspection Program. What Is It?

Our Field Rotor Inspection Program (FRIP) has two purposes: to prevent premature rotor failures by detection of stress corrosion, metal fatigue, wear or damage to anodized coatings; and to instruct laboratory personnel in the proper care of rotors.

Contact your local Beckman Coulter Service Office for details on the Field Rotor Inspection Program. Using nondestructive methods (fiber optics borescopy and dyepenetrant analysis), they may find signs of corrosion or other damage. If so, they will recommend repair or replacement, and a potentially costly failure may be prevented.

To give a fuller understanding of rotors, a comprehensive slide presentation is also offered. Centrifuge users are informed about maintenance procedures, rotor damage, and its significance. The stress corrosion of aluminum rotors, in particular, can be greatly reduced by good laboratory practice.

For more information about the Field Rotor Inspection Program (FRIP), please go to: www.beckmanbuilt.com.

Sometimes rotor corrosion is so bad it can be seen by the naked eye, while at other times it is not so apparent. If you have doubt about the condition of a single Beckman Coulter rotor, you may return it to the factory where it will be inspected free of charge by our metallurgists. The rotor will be examined by a variety of nondestructive methods, including ultrasound which is capable of detecting internal flaws. Before shipping the rotor, you must contact the nearest Beckman Coulter Sales and Service office for specific instructions. A written statement must accompany each rotor, indicating that it is safe to handle, (i.e. free of any pathogenic or radioactive contamination).

Rotor Safety Seminars

To help you get the most from your Beckman Coulter rotors, Rotor Safety Seminars are frequently presented by our Field Service engineers. Seminars are designed to remind centrifuge users about the importance of proper rotor care and maintenance.

When you attend a Beckman Coulter Rotor Safety Seminar, you will have an opportunity to ask questions that are specific to your particular situation, and you will learn:

- What causes corrosion in a rotor, where it starts, what it does to the rotor, and how to avoid it.
- The proper way to clean and store rotors.
- How to get longer life from your rotor.

On-Site Rotor Inspection and Maintenance

Specially trained Beckman Coulter Field Service engineers are available at your request for on-site inspection and minor rotor maintenance. Rotors that are free of biological and radiological contamination can be brought to these sessions for immediate inspection so you can continue operating your centrifuge with confidence in the condition of your rotors.

A Comprehensive Approach to Centrifuge System Care

Throughout the world, Beckman Coulter Field Service engineers are on hand to provide the support you need. So you can operate your centrifuges worry-free, a number of programs are in place that cover preventive maintenance of your system, including parts, labor, drive systems, and rotors. It all adds up to a comprehensive approach to maximizing your system investment.

Contact your local Beckman Coulter Sales and Service office to find out the specifics about the program available in your area.

ULTRACENTRIFUGATION

WITHOUT LIMITATION.

Starting with the innovations created by our founder, Arnold O. Beckman Ph.D., Beckman Coulter has lived at the forefront of the technology that continues to help improve life for all of humankind.

Our foray into the world of ultracentrifugation is no different. In fact, we introduced the first commercial ultracentrifuge in 1947. Since then, our elite line of ultracentrifuges has attained incredible levels of speed and sophistication, without sacrificing usability.

Not unlike the rest of our portfolio of products, our ultracentrifugation solutions certainly live up to the Beckman Coulter name—a name in which laboratories around the world continue to have the utmost confidence.



Optima MAX-XP Ultracentrifuge

A global presence. Focused on individuals.

We may not be a household name. Yet we touch people the world over by developing, manufacturing and marketing discovery systems and products that improve human health.

For over 75 years, we've been building a global reputation in hospitals, labs, and universities, where our life science research instruments are relied upon to perform vital roles day in and day out. Whether helping to solve complex biological problems, investigate the causes of disease, or find potential new cures, Beckman Coulter is focused on innovations that ultimately lead to healthier lives.



beckman.com/centrifuges



BioSafe and BioSafety are terms intended to describe the enhanced biocontainment features of our products.



BioCertified is a term used to describe our products which have been tested and validated to demonstrate containment of microbiological aerosols by an independent, third-party facility (Health Protection Agency, Porton Down, UK). Improper use or maintenance may affect seal integrity and, thus, containment.



BioEnhanced is a term intended to describe our products' enhanced level of biocontainment by design.



Beckman Coulter, the stylized logo, and the Beckman Coulter product and service marks mentioned herein are the trademarks or registered trademarks of Beckman Coulter, Inc. in the United States and other countries. All other trademarks are the property of their respective owners.

For Beckman Coulter's worldwide office locations and phone numbers, please visit beckman.com/contact-us

CENT-7631CAT08.20 © 2020 Beckman Coulter, Inc. PRINTED IN U.S.A.